



TENDER

FOR

“Design, construction, supply installation, testing and commissioning of 10 nos. Concrete Jetties in New National Waterways in J&K”.

TENDER No: IWAI/Tech/NNWs/NorthernIndia/2024

INLAND WATERWAYS AUTHORITY OF INDIA

(Ministry of Ports, Shipping & Waterways)

Jalmarg Bhawan

A-13 Sector-1

Noida-201301

November 2024

DISCLAIMER

1. This Tender Document is neither an agreement nor an offer by the Inland Waterways Authority of India (IWAI) to the prospective Applicants or any other person. The purpose of this Tender Document is to provide information to the interested parties that may be useful to them in the formulation of their Bid pursuant to this Tender Document.
2. IWAI does not make any representation or warranty as to the accuracy, reliability or completeness of the information in this Tender Document and it is not possible for IWAI to consider particular needs of each party who reads or uses this Tender Document. This Tender Document includes statements which reflect various assumptions and assessments arrived at by IWAI in relation to the Works of design, construction, supply, installation, testing and commissioning of pontoons, and gangways for providing floating terminal facilities. Such assumptions, assessments and statements do not purport to contain all the information that each Applicant may require. Each prospective Applicant should conduct its own independent investigations and analyses and check the accuracy, reliability and completeness of the information provided in this Tender Document and obtains independent advice from appropriate sources.
3. IWAI will not have any liability to any prospective Company/ Firm/Consortium or any other person under any laws (including without limitation the law of contract, tort), the principles of equity, restitution or unjust enrichment or otherwise for any loss, expense or damage which may arise from or be incurred or suffered in connection with anything contained in this Tender Document, any matter deemed to form part of this Tender Document, the award of the Assignment, the information and any other information supplied by or on behalf of IWAI or their employees, any Contractors or otherwise arising in any way from the selection process for the Assignment. IWAI will also not be liable in any manner whether resulting from negligence or otherwise however caused arising from reliance of any Applicant upon any statements contained in this Tender Document.
4. IWAI will not be responsible for any delay in receiving the Bids. The issue of this Tender Document does not imply that IWAI is bound to select a Bidder or to appoint the Successful Bidder, as the case may be, for the Works and IWAI reserves the right to accept / reject any or all of Bids submitted in response to this Tender Document at

any stage without assigning any reasons whatsoever. IWAI also reserves the right to withhold or withdraw the process at any stage with intimation to all who submitted the Bids.

5. The information given is not an exhaustive account of statutory requirements and should not be regarded as a complete or authoritative statement of law. IWAI accepts no responsibility for the accuracy or otherwise for any interpretation or opinion on the law expressed herein.
6. IWAI reserves the right to change / modify / amend any or all provisions of this Tender Document. Such revisions to the Tender Document / amended Tender Document will be made available on the website of IWAI.

Table of Contents

DISCLAIMER	2
Table of Contents	4
SECTION-I: NOTICE INVITING E-TENDER	7
SECTION-II: INSTRUCTIONS TO BIDDERS (ITB)	11
1. Background	12
2. Introduction	13
3. Bidder Eligibility Criteria	14
4. Pre-bid Meeting	15
5. Clarifications and Addendums	16
6. Preparation of Bids	17
6.1 EMD	17
6.2. Tender Fee	18
6.3. Bank Solvency	19
6.4. Taxes	19
6.5. Currency	19
6.6. Language	19
6.7. Bid Validity	20
6.8. Number of Bids	20
6.9. Bids by Joint venture/consortium	20
7. Conflict of Interest	20
8. Acknowledgement by Bidder	22
9. Guidelines for e-submission of the Bids	22
10. Submission of Bids	26
11. Extension of Bid submission date	29
12. Late Proposals	29
13. Liability of the employer	29
14. Modification/Substitution/ Withdrawal of Bids	30
15. Bid opening and evaluation process	30
16. Qualification Criteria and Bid evaluation	31
17. Award of Contract	34
18. Mobilization of Equipment, Men & Materials	35
19. Ownership of Document and Copyright	35
SECTION - III: DATA SHEET	36

SECTION-IV: TECHNICAL BID STANDARD FORMS	40
FORM 4A: Form of Tender	41
FORM 4B: Eligible Projects	44
FORM 4C: Average Annual Turnover of the Bidder	46
FORM 4 D: Power of Attorney.....	47
FORM 4E: List of Key Personnel.....	49
FORM 4F: List of Ongoing Assignments.....	50
FORM 4G: Declaration by the Bidders	51
FORM 4H: Bidders Information Form	52
FORM 4I: Availability of infrastructural facility, equipment, machineries etc. to be used for tender work	53
Detailed Particulars	53
FORM 4J: Format for Pre bid queries by Bidders	54
FORM 4K: Power of Attorney for Lead Member of JV/Consortium.....	55
FORM 4L: Statement of Legal Capacity	58
FORM 4M: Joint Bidding Agreement	59
FORM 4N: General Construction Experience	65
FORM 4O: Bid Capacity	66
SECTION - V: FINANCIAL BID STANDARD FORMS.....	67
Form Fin – 1: Financial Bid Submission Form.....	68
Form Fin – 2: Summary of Cost	69
Form Fin – 2 A: BOQ-1(Online specimen- To be filled in online is excel sheet under financial cover) ...	70
SECTION-VI: TERMS OF REFERENCE (ToR).....	71
PART I – DETAILED SCOPE OF WORK.....	72
PART II – TECHNICAL SPECIFICATIONS	81
SECTION - VII: GENERAL CONDITIONS OF CONTRACT	97
SECTION - VIII: SPECIAL CONDITIONS OF CONTRACT (SCC)	188
SECTION-IX: ANNEXES	197
ANNEX - I: BANK GUARANTEE FORM FOR PERFORMANCE SECURITY	198
ANNEX - II: AGREEMENT FORM.....	201
ANNEX -III:DETAILS OF BANK ACCOUNT	203
ANNEX-IV:BANK CERTIFICATION	204
ANNEX-V: TENDER ACCEPTANCE LETTER	205
ANNEX-VI: LETTER OF CONSENT.....	206

ANNEX-VII: INTEGRITY AGREEMENT	207
ANNEX-VIII: General Drawing for connection of gangway.....	214

SECTION-I: NOTICE INVITING E-TENDER

INLAND WATERWAYS AUTHORITY OF INDIA

(Ministry of Ports, Shipping & Waterways, Government of India)

A-13, Sector-1, Gautama Buddha Nagar, NOIDA, U.P. -201301

Tel (0120) 2522971: Fax (0120)2522969

Email: ce.iwai@iwai.nic.in

Website: <https://www.iwai.nic.in> & <https://eprocure.gov.in/eprocure/app>

IWAI/Tech/NNWs/NorthernIndia/2024

NOTICE INVITING E-TENDER

1.1. Introduction:

Inland Waterways Authority of India (IWAI) invites online Bids **from the reputed Contractors/Companies/Firms.** in two cover system (Cover – I: Technical Bid and Cover – II: Financial Bid) for “**Design, construction, supply installation, testing and commissioning of 10 nos. Concrete Jetties in New National Waterways in J&K**”.

Sl. No.	Name of State	NW's	No. of jetties	Location of Concrete Jetty (Size)
1.	Jammu & Kashmir	Chenab River (NW-26)	2	1 Jetty at Aknoor (30m*6m)
				1 Jetty at Reasi (24m*6m)
2.	Jhelum River (NW-49)	7	1 Jetty at Panth Chowk (30m*6m)	
			1 Jetty at Zero Bridge (30m*6m)	
			1 Jetty at Amira Kadal (30m*6m)	
			1 Jetty at Shah-e-Hamdan (30m*6m)	
			1 Jetty at Safa Kadal/Chattabal Shrine (30m*6m)	
			1 Jetty at Sumbal Bridge (30m*6m)	
3.	Ravi River (NW-84)	1	1 Jetty at Gund Prang (30m*6m)	
			1 Jetty at Ranjit Sagar Dam U/S (30m*6m)	

1.2. Critical Data sheet:

Interested parties may download the Tender document online from the site <https://eprocure.gov.in/eprocure/appand> IWAI's website “www.iwai.nic.in” and pay the cost of Tender Document Rs. 5,900/- including GST (i.e. Rs. 5000/- tender fee + Rs. 900/- @18%GST i.e. 0.18 x Rs. 5,000/-) be deposited to IWAI Fund. However, Micro and Small Enterprises (MSEs) as defined in MSE procurement policy issued by department of Micro, Small and Medium Enterprises (MSME) or start-ups as

recognized by Department of Promotion for Industrial and internal trade (DPIIT) are exempt from submitting the Tender Fee in submission of documents to the extent as per Government of India rules.

Document Download Start Date	28.02.2025 @ 0900 hrs
Date of submission of pre-bid queries	10.03.2025 @ 1500 hrs
Pre-bid meeting	11.03.2025 @ 1500 hrs
Bid Submission Last Date	01.04.2025 @ 1530 hrs
Bid Opening Date	02.04.2025 @1530 hrs
EMD	Rs. 71.25 Lakhs

1.3. Scope of the work:

In brief, the Scope of Work for the appointed firm shall be "Design, construction, supply installation, testing and commissioning of 10 nos. Concrete Jetties in New National Waterways in J&K". As per the terms and conditions and technical specifications stipulated in the Tender Document.

The detailed Terms of Reference (ToR) / Scope of Work shall be as described in the Section-VI of this Tender Document.

1.4. Method of Selection:

Bidder will be selected under Cost Based Selection (CBS) L-1. The lowest priced bidder i.e. L1 shall be chosen based on the amount quoted by the bidders in BOQ.

1.5. Clarification

Clarification / Query

if any on the Tender Document shall be obtained from the following address:

The Member (Tech)

Inland Waterways Authority of India

A-13, Sector – 1,

Noida-201301

Tel: (0120) 2522971, Fax (0120) 2544041

**Email id: mt.iwai@nic.in, singh@iwai.gov.in, srafat@iwai.gov.in,
ppolagani.iwai@nic.in, rpatel@iwai.gov.in**

Website: www.iwai.nic.in.

IWAI reserves the right to accept or reject any or all Tenders without assigning any reason and no correspondence shall be entertained in this regard.

Member (Tech)
IWAI, Noida

SECTION-II: INSTRUCTIONS TO BIDDERS (ITB)

1. Background

- 1.1 Inland Waterways Authority of India (IWAI) [hereinafter referred to as "employer"] is a statutory body under the Ministry of Ports, Shipping & Waterways, Government of India. IWAI was set up in 1986 for regulation and development of Inland Waterways for the purposes of shipping and navigation. IWAI is primarily responsible for development, maintenance and regulation of Inland Water Transport (IWT) in the country and specifically National Waterways (NW). In April, 2016, the Government of India has declared 106 new National Waterways in addition to the existing five National Waterways.
- 1.2 Inland Waterways Authority of India primarily undertook the work of development activities in 5 National waterways i.e National Waterway No-1 (Allahabad-Haldia Stretch of the Ganga Bhagirathi- Hooghly River) Act, 1982, National Waterway No-2 (Sadiya-Dhubri Stretch of Brahmaputra River) Act, 1988, National Waterway No 3 (Kollam-Kottapuram Stretch of West Coast Canal and Champakara and Udyogmandal Canals) Act, 1992 , National Waterway No-4 (Talcher-Dhamra Stretch of Rivers, Geonkhali- Charbatia Stretch of East Coast Canal, Charbatia-Dhamra Stretch of Matai River and Mahanadi Delta Rivers) Act, 2008 and National Waterway No-5 (Kakinada-Puducherry Stretch of Canals and the Kaluvelly Tank, Bhadrachalam-Rajahmundry Stretch of River Godavari and Wazirabad- Vijayawada Stretch of River Krishna) Act, 2008 under the ambit of IWAI Act 1985.
- 1.3 Inland Water Transport (IWT) has the potential to form the most economic, reliable, safe and environmentally friendly form of transport. When developed for use by modern inland waterway vessels, it can reduce investment needs in rail and road infrastructure, promote greater complementarities in the riparian states, enhance intra-regional trade and, through increased economies of scale, significantly reduce overall logistics costs for the benefit of the entire economy and India's global trade competitiveness.
- 1.4 Among the various interventions being undertaken by IWAI is construction of multi modal terminal, setting up of floating terminals at various locations, setting up of RIS services, provision of Ro-Ro services dredging across the across the aforementioned national waterways.
- 1.5 The Parliament of India in the year 2016 enacted the National Waterways Act 2016 vide which additional 106 National Waterways were declared. Total 3 nos National

Waterways either pass through or are in the UT of Jammu & Kashmir i.e. Chenab River (NW-26), Jhelum River (NW-49) & Ravi River (NW-84).

- 1.6 After declaration of National Waterways, IWAI prepared the FSR in the first instance and the waterways that were found feasible, DPR's were prepared for these National Waterways. The FSR and DPR can be accessed through the links <http://iwai.nic.in/fsr-report> and <http://iwai.nic.in/waterways/dpr-report> respectively.
- 1.7 Chenab River (NW-26) has been declared as NW-26 from Chenab Road Bridge (Reasi) to bridge near Bhardakalan Village (near Jammu). The NW is situated near the sensitive Indo-Pak Border. A river cruise is proposed from Reasi to Akhnoor Fort. The Akhnoor Fort in Jammu is a major tourist spot and is intended to be connected through 2 jetties for cruise tourism at Akhnoor & Reasi.
- 1.8 River Jhelum (NW-49) has been declared as NW from Sangam (Anantnag) to Wular Lake. The DPR has been prepared by WAPCOS and it is proposed to be developed from River Cruise tourism point of view.
- 1.9 River Ravi (NW-84) has been declared as NW-84 from Ranjit Sagar Dam to Chamera Dam at Gandhian. The NW passes through the UT of J&K and states of Himachal Pradesh and Punjab. The total declared length is 44.276 Kms. This NW has been considered for River Cruise Tourism. The proposed cruise length is 14.4 Km. The dam area is a major tourist spot.

2. Introduction

- 2.1 The Employer will select a firm / organization (the "Contractor") in accordance with the evaluation process and method of selection specified in **Clause 16 & clause 16.2 Section- II: Instruction to Bidder (ITB)**.
- 2.2 The name of the Assignment/Job has been mentioned in **Section - III: Data Sheet**. Detailed scope of the Assignment/Job has been described in **Section - VI: Terms of Reference**.
- 2.3 The date, time and address for submission of the Bids have been given in **Section - III: Data Sheet**.
- 2.4 Bidder shall bear all costs associated with the preparation and submission of their Bids and contract negotiation.

2.5 The Employer is not bound to accept any Bid and reserves the right to annul the selection process at any time prior to contract award, without thereby incurring any liability to the Bidder.

3. Bidder Eligibility Criteria

The Bidders shall meet the following pre-qualification criteria:-

- 3.1 Bidder may be a firm that is a private entity, a Government owned entity ~~or any combination of such entities in the form of JV/consortium under an existing agreement or with the intent to enter into such agreement supported by a Letter of Intent~~. Bidders that are Government owned entity in the employer's country may participate only if they can establish that they (i) operate under commercial law and (ii) are not dependent agencies of the employer.
- 3.2 The Bidder shall meet the Qualification criteria of executing similar works of the value as mentioned in **Clause 16.1 of ITB**. The Bidder shall indicate the value of the order executed by him together with the details of name of the party, order value, scope of work / component breakup, completion period stipulated in the order and actual completion period. The completion certificate, awarded by the client on its letter head should have a mention of start date, date of completion and value of the work executed by the Bidder. In case the work was performed by the Bidder in a JV, the same shall be supported by a Client Certificate enumerating the claimant share also. In case the work was performed by the bidder as a sub-contractor, the bidder shall submit similar completion certificate awarded to it by the main contractor and countersigned by the Employer / Client of the main contractor.
- 3.3 Copy of work order/letter of award/letter of work agreement alone shall not suffice Bidders claim for executing the similar work as defined in Section III data sheet. Submitting completion certificate from the client on its letter head is mandatory.
- 3.4 Average Annual Turnover during the last three (03) years ending 31st March of the previous financial year should be as mentioned in **Clause 16.1.2 of ITB**. The Bidders shall provide financial turnover of the firm for the last three years duly certified by statutory auditors.
- 3.5 Any entity which has been barred by the Central Government, any State Government, a statutory Authority or a public-sector undertaking, as the case may be, from participating in any project, and the bar subsists as on the Bid submission date, would not be eligible to submit Bid.

~~3.6~~ The similar work experience of parent company/subsidiary/sister Company or any associated firm/company of the Bidder shall not be considered ~~unless the parent company/subsidiary/sister company or associated firm/company is part of the JV/consortium participating in the Bid.~~

3.7 The Bidder shall offer and make available the list of all Key Personnel as specified in **Clause - 7 of Section – VI: Terms of Reference.**

3.8 Bidder should have, during the last three years, neither failed to perform on any agreement, nor been expelled from any project or agreement nor have had any agreement terminated for breach by such Bidder.

3.9 The Bidder shall also indicate following:

3.9.1 The Bidder shall have adequate resources for successful execution from design to construction and commissioning of floating pontoons and gangways and should be financially solvent. Bidder shall provide a solvency certificate from any nationalized/scheduled bank in India for an amount as indicated in Section - III: Data Sheet.

3.9.2 The Bidder shall be income tax assesses and accordingly the Bidder shall submit copy of Income Tax Return (ITR) filed by the Bidder for the last three financial years.

3.9.3 A preliminary design and detailed schedule of detailed design, supply, installation, testing and commissioning (the GAD is to be submitted alongwith the bid and the design is to be submitted to NTCPCW for approval) is required to be submitted.

3.9.4 The details of manufacturing yard(with registration) and survey certificate (if any) as the proof of adequate capacity available for the work which must include the size, capacity and facilities etc, is required to be furnished along with the registration and survey certificate (if any) from the concerned organization.

4. Pre-bid Meeting

A Pre-Bid meeting in Hybrid mode shall be held as per the date and time mentioned in Section III - Data Sheet. During the course of Pre-Bid Meeting, the Bidders will be free to seek clarifications and make suggestions for consideration by the Employer. The Employer will endeavour to provide clarifications and such further information as it may, in its sole discretion, consider appropriate for facilitating a fair, transparent and competitive selection process. The link for pre bid meeting is as follows

5. Clarifications and Addendums

- 5.1 Bidders may request a clarification on any clause of the document up to the number of days indicated in Section-III: Data Sheet before the Bid submission date. Any request for clarification must be sent in writing, or by e-mail to the Employer's address indicated in Section-III: Data Sheet.
- 5.2 The Employer/IWAI will respond in writing or by e-mail and will send written copies of the response (including an explanation of the query but without identifying the source of query) to Bidders. Should the Employer deem it necessary to amend the Tender document as a result of a clarification, it shall do so following the procedure mentioned hereunder:
- (i) At any time before the submission of Bids, the Employer may amend the tender document by issuing an addendum/corrigendum (amendment) in writing or by e-mail. The information of issue of such amendment shall be sent to all Consultants and will be binding on them. Consultants shall acknowledge receipt of all amendments. To give Consultants reasonable time to the bidders to take an amendment into account, the Employer may, if the amendment is substantial, extend the deadline for the submission of
- 5.1 Bidders may request a clarification on any clause of the document up to the number of days indicated in Section - III: Data Sheet before the Bid submission date. Any request for clarification must be sent in writing, or by e-mail to the Employer's address indicated in Section - III: Data Sheet. No request for the clarification shall be entertained if such request is received by the client after the deadline for submitting clarifications.
- 5.2 The Employer will respond to the queries raised by the Bidders (including an explanation of the query but without identifying the source of query) along with any amendment, which would be published on the website and e-procurement portal. The Employer shall use the following procedure mentioned hereunder:
- (i) At any time before the submission of Bids, the Employer may amend the tender document by issuing an addendum / corrigendum (amendment). The amendment / clarification, if any, to the document will be available on <https://eprocure.gov.in/eprocure/appand> & on IWAI's website "www.iwai.gov.in". All Bidders participating in the Bid shall be deemed to have kept

them informed and updated about each such amendment/clarification which is posted on the above website from time to time. Declaration on the issue has been built up at S. No. 9 of Form 4G.

6. Preparation of Bids

In preparing their Bid, Bidders are expected to examine in detail the documents comprising the Tender Document. Material deficiencies in providing the requested information may result in rejection of the Bidder's Bid.

Bidders shall adhere to the requirements mentioned below:

6.1 EMD

~~6.1.1.~~ Bidders shall furnish EMD of the amount as mentioned in Section III Data Sheet except Micro and Small Enterprises (MSEs) as defined in MSE Procurement Policy issued by Department of Micro, Small and Medium Enterprises (MSME) or Department or Startups as recognized by Department of Promotion of Industry and Internal Trade (DPIIT) on submission of a valid registration certificate (**subject to being in the appropriate category of work**) as per the Government of India rules. ~~In case of a JV, the EMD shall be furnished by the Lead Member (refer clause 6.9.11 of ITB)~~

EMD for the amount mentioned above shall be deposited to IWAI Fund through RTGS in the following account:

i.) Name of Bank Account:	IWAI FUND
ii.) Bank Name and Address	Union Bank of India, Sector 15, Noida
iii.) Bank Account Number	513202050000007
iv.) IFSC	UBIN0551325

6.1.2. Bids submitted without EMD shall be rejected as non-responsive.

6.1.3. No interest shall be payable by the Employer for the sum deposited as earnest money deposit.

6.1.4. The EMD of the unsuccessful bidders would be returned within one month of signing of the contract with the successful bidder.

6.1.5. The Earnest Money of the successful Bidder submitted in the form of RTGS will be retained as Security Deposit.

6.1.6. The EMD shall be forfeited by the Employer in the following events:

- (i) If Bid is withdrawn during the validity period or any extension agreed by the Bidder thereof.
- (ii) If the Bid is varied or modified in a manner not acceptable to the Employer after opening of Proposal during the validity period or any extension thereof.
- (iii) If the Bidder tries to influence the evaluation process.
- (iv) If the Bidder withdraws his proposal during negotiations.
- (v) In case the Bidder, submits false certificate in terms of any documents supported to such Tender.
- (vi) If the Bidder fails to sign the contract in accordance with Conditions of Contract on receipt of award of work
- (vii) In case of a Bidder revoking or withdrawing his Tender or varying any terms in regard thereof without the consent of the Employer in writing.
- (viii) In case the bidder is found to indulge in corrupt or fraudulent practices at any stage of the execution of the contract, as described in Clause 17.5 of GCC.
- (ix) In case the bidder fails to furnish the prescribed performance guarantee within the prescribed period as mentioned in clause 4.4.1 of GCC.
- (x) In case of forfeiture of earnest money, as prescribed in vii and ix above, the tenderer shall not be allowed to participate in the retendering process of the work.

6.2. Tender Fee

All Bidders except Micro and Small Enterprises (MSEs) as defined in MSE Procurement Policy issued by Department of Micro, Small and Medium Enterprises (MSME) or Department or Startups as recognized by on submission of a valid registration certificate as per the Government of India rules are required to pay the cost of Tender Document as mentioned in Section-III, Clause 8 of Data Sheet through RTGS. The cost of Tender Document is Non-Refundable. In case of a JV, refer clause 6.9.11 of ITB.

- | | |
|-----------------------------------|--|
| i.) Name of Bank Account: | IWAI FUND |
| ii.) Bank Name and Address | Punjab National Bank, Sector – 18, Noida |
| iii.) Bank Account Number | 3702000100833867 |

iv.) IFSC

PUNB0370200

6.3. Bank Solvency

All bidders shall submit bank solvency certificate from a nationalized/scheduled bank in India for the amounts as mentioned in Section III Data Sheet.

The solvency certificate submitted by the bidder shall not be older than one (01) year from the Bid Submission Last Date. In case bidder does not adhere to this criterion, his bids shall be considered non-responsive and shall not be considered for further evaluation process. The bank solvency certificate shall be from any Nationalized/Scheduled Bank in India in the name of the bidder. ~~The bank solvency certificate can be submitted by any one member of the JV / Consortium and the name of that member submitting the bank solvency certificate shall be mentioned in the JV / Consortium Agreement.~~

6.4. Taxes

The Bidders shall fully familiarise themselves with the applicability of all types of taxes and all such taxes, as prevailing on date of submission of the bid, must be included by the Bidder in the Financial Proposal along with the conditions mentioned therein, except for GST which will be quoted separately by the Bidder as per Form Fin – 2. It may be noted that the bidder shall have to be registered with GST and shall submit the proof of the same. The GST and all other relevant taxes shall be as per existing rules and regulations at the time of payment.

6.5. Currency

Bidders shall quote the price of their Assignment/job in Indian Rupees.

6.6. Language

The Bid as well as all related correspondence exchanged between the Bidders and the Employer shall be in English language and shall be strictly as per the formats attached in this Tender Document. The Employer will evaluate only those Bids that are received in the specified formats and are complete in all respects as per this Tender Document. Any supporting documents submitted by the Bidder with its Bid or subsequently, in response to any query/ clarification from the Employer shall be in English and in case any of these documents is in another language, it must be accompanied by an accurate translation of all the relevant passages in English, and in

such case, for all purposes of interpretation of the Bid, the translation in English shall prevail.

6.7. Bid Validity

The Section – III: Data Sheet indicates for how long the Bids submitted by the bidders must remain valid after the submission date. During this period, Bidders shall maintain the availability of Professional staff nominated in the Bid and also the amount quoted for the services in the Financial Bid shall remain unchanged. Should the need arise; however, the Employer may request Bidders to extend the validity period of their Bids. Bidders who agree to such extension shall confirm that they will maintain the availability of the Professional staff Proposed in the Bid and that their financial Bid will remain unchanged. Also, in their confirmation of extension of validity of the Bid, bidders could submit new staff in replacement, which would be considered in the final evaluation for contract award. The bidders have the right to refuse to extend the validity of the bids and bids of such bidders, who do not extend the validity of their bids, shall not be considered for further evaluation.

6.8. Number of Bids

A bidder can submit one bid only either as a single entity ~~or in the form of a JV/consortium~~. In case a bidder submits or participates in more than one bid, the application of the bidder shall be rejected summarily.

6.9. Bids by Joint venture/consortium

6.9.1. Bids by JV/Consortium is not applicable.

7. Conflict of Interest

- 7.1 Employer requires that selected bidder (Contractor) provides professional, objective, and impartial advice and at all times holds the Employer's interests paramount, strictly avoids conflicts with other assignment(s)/job(s) or his own corporate interests and act without any consideration for future work.
- 7.2 Without limitation on the generality of the foregoing, Bidders, and any of their affiliates, shall be considered to have a conflict of interest and shall not be recruited, under any of the circumstances set forth below:-
- (a) **Conflicting Activities:** A firm or any of its affiliates who have been engaged by the Employer to provide goods, works or assignment/job other than design and build assignment/job for a project shall be disqualified from providing design and build assignment/job related to those goods, works or assignments/ jobs. Conversely, a firm

or any of its affiliates who have been hired to provide design and build assignment/job for the preparation or implementation of a project, and any of its affiliates, shall be disqualified from subsequently providing goods or works or assignment/job other than design and build assignment/job resulting from or directly related to the firms design and build assignment/job for such preparation or implementation. For the purpose of this paragraph, assignment/ job other than design and build assignment/job are defined as those leading to a measurable physical output; for example surveys, exploratory drilling, aerial photography, satellite imagery etc.

- (b) **Conflicting assignment/ job:** A Contractor {including its Personnel and Sub-Contractor(s)} or any of its affiliates shall not be hired for any assignment/ job that by its nature may be in conflict with another assignment/ job of the Contractor to be executed for the same or for another Employer, for example a Contractor hired to prepare engineering design for an infrastructure project shall not be engaged to prepare an independent environmental assessment for the same project and a Contractor assisting an Employer in the privatization of public assets shall not purchase nor advise purchasers of such assets.
- (c) **Conflicting Relationships:** A Contractor (including its Personnel and Sub-Contractors) that has a business or family relationship with a member of the Employer's staff who is directly or indirectly involved in any part of (i) the preparation of the Terms of Reference of the assignment/job (ii) the selection process for such assignment/job or (iii) supervision of the Contract, may not be awarded a Contract unless the conflict stemming from this relationship has been resolved in a manner acceptable to the Employer throughout the selection process and the execution of the Contract.
- 7.3 Contractors have an obligation to disclose any situation of actual or potential conflict that impacts their capacity to serve the best interest of their Employer, or that may reasonably be perceived as having this effect. Any such disclosure shall be made as per the standard forms of technical proposal provided herewith. If the Contractor fails to disclose said situations and if the Employer comes to know about any such situation at any time, it may lead to the disqualification of the Contractor during bidding process or termination of its Contract during execution of assignment on this ground alone.

7.4 No agency or current employees or consultants of the Employer shall work as Contractors under their own ministries, departments or agencies. The contract is liable for cancellation if either the Contractor himself or any of his employees or representatives are found to be persons/person who have held class I post under IWAI immediately before retirement and has within two years of such retirement accepted without obtaining the previous permission of IWAI, or the chairman as the case may be, and employment as contractor, or in connection with the execution of the public works, or as an employee of such contractor. If the contract is terminated on account of the failure of the contractor to comply with this clause, IWAI shall be entitled to recover from him such damages as may be determined by the Engineer in Charge with due regard to the inconvenience caused to IWAI on account of such termination without prejudice to IWAI's right to proceed for legal action against such officer.

8. Acknowledgement by Bidder

It shall be deemed that by submitting the Bid, the Bidder has:-

- 8.1 Made a complete and careful examination of this "Design, construction, supply installation, testing and commissioning of 10 nos. Concrete Jetties in New National Waterways in J&K".
- 8.2 Received all relevant available information requested from the Employer;
- 8.3 Satisfied itself about all matters and necessary information required for submitting a competitive bid; inter-alia including fully familiarizing itself with the site and other conditions prevailing at site.
- 8.4 Updated itself about any amendments / clarifications that have been posted on the website in terms of clause 5.2 above.
- 8.5 Acknowledged that he does not have a Conflict of Interest; and
- 8.6 Agreed to be bound by the undertaking provided by him under the terms and conditions laid in this tender document.

9. Guidelines for e-submission of the Bids

- 9.1 The Bids should be submitted through Central Public Procurement Portal for e-Procurement <https://eprocure.gov.in/eprocure/app>

-
- 9.2 Possession of valid Digital Signature Certificate (DSC) and enrolment/registration of the Contractors/Bidders on the e-procurement/e-Tender portal is a prerequisite for e-Tendering.
 - 9.3 Bidder should enrol in the e-Procurement site using the <https://eprocure.gov.in/eprocure/app> option available "Enrol Here" on the home page portal. Enrolment is free of charge. During enrolment/registration, the Bidders should provide the correct/true information including valid e-mail id. All the correspondence shall be made directly with the Contractors/Bidders through email id provided.
 - 9.4 Bidders need to login to the site through their user ID/password chosen during enrolment/registration.
 - 9.5 Then the Digital Signature Certificate (Class - II or Class - III Certificates with signing key usage) issued by SIFY/TCS/node/e-Mudra or any Certifying Employer recognized by CCA India on e-Token/Smart Card, should be registered.
 - 9.6 Only the registered DSC should be used by the Bidder and should ensure safety of the same.
 - 9.7 Bidder may go through the Tenders published on the site and download the required Tender documents/schedules in which the Bidder is interested.
 - 9.8 After downloading/getting the Tender document/schedules, the Bidder should go through them carefully and then submit the documents as asked.
 - 9.9 If there are any clarifications, this may be obtained online through the Tender site, or through the contact details as specified in Section – III: Data Sheet. The Bidder should also take into account the addendum/corrigendum published before submitting the Bids online.
 - 9.10 Then the Bidder may log into the site through the secured log in by giving the user id/ password chosen during enrolment/registration and then by giving the password of the e-Token/Smart card to access DSC.
 - 9.11 Bidder selects the tender which he/she is interested in by using the search option & then moves it to the 'my favourites' folder.
 - 9.12 From the favourite's folder, he selects the tender to view all the details indicated.
 - 9.13 It is construed that the bidder has read all the terms and conditions before submitting their offer. Bidder should go through the tender schedules carefully and upload the documents as asked; otherwise, the bid will be rejected.

-
- 9.14 Bidder, in advance, should get ready the Bid documents to be submitted as indicated in the Tender document/schedule and generally, they can be in general PDF/xls/rar/jpg formats. If there is more than one document, they can be clubbed together and can be provided in the requested format. Each document to be uploaded online should be less than 2 MB. If any document is more than 2MB, it can be reduced through zip/rar and the same can be uploaded, if permitted.
- 9.15 The Bidders can update well in advance, the documents such as certificates, annual report details etc., under My Space option and these can be selected as per Tender requirements and then sent along with Bid documents during Bid submission. This will facilitate the Bid submission process making it faster by reducing upload time of Bids.
- 9.16 Bidder should submit the Cost of Tender document/ EMD for the amount as specified in Section –III: Data Sheet. The original payment instruments should be posted/couriered/given in person to the employer within the due date as mentioned in this Tender document. Scanned copy of the instrument should be uploaded as part of the offer, if asked for.
- 9.17 While submitting the Bids online, the Bidder should accept the Terms & Conditions and proceed further to submit the Bid packets.
- 9.18 The Bidder has to select the payment option as offline to pay the Cost of Tender Document/ EMD as applicable and enter details of the instruments.
- 9.19 The details of the DD/any other accepted instrument, physically sent, should tally with the details available in the scanned copy and the data entered during Bid submission time. Otherwise submitted Bid will not be acceptable.
- 9.20 The Bidder has to digitally sign and upload the required Bid documents one by one as indicated. Bidders to note that the very act of using DSC for downloading the Bids and uploading their offers shall be deemed to be a confirmation that they have read all sections and pages of the Bid document including conditions of contract without any exception and have understood the entire document and are clear about the requirements of the Tender requirements.
- 9.21 The Bidder has to upload the relevant files required as indicated in the cover content. In case of any irrelevant files, the Bid will be automatically rejected.
- 9.22 If the price Bid format is provided in a spread sheet file like BoQ_xxxx.xls, the rates offered should be entered in the allotted space only and uploaded after filling the

-
- relevant columns. The Price Bid/BOQ template must not be modified/replaced by the Bidder; else the Bid submitted is liable to be rejected for this Tender.
- 9.23 The Bidders are requested to submit the Bids through online e-tendering system to the Tender Inviting Authority (TIA) well before the Bid submission end Date & Time (as per Server System Clock). The TIA will not be held responsible for any sort of delay or the difficulties faced during the online submission of Bids by the Bidders at the eleventh hour.
- 9.24 After the Bid submission, the acknowledgement number, given by the e-tendering system should be printed by the Bidder and kept as a record of evidence for online submission of Bid for the particular Tender and will also act as an entry pass to participate in the Bid opening date.
- 9.25 The Bidder should ensure/see that the Bid document submitted is free from virus and if the documents could not be opened, due to virus, during Tender opening, the Bid is likely or liable to be rejected.
- 9.26 The time settings fixed in the server side & displayed at the top of the Tender site, will be valid for all actions of requesting, Bid submission, Bid opening etc., in the e-Tender system. The Bidders should follow these time settings during Bid submission.
- 9.27 All the data being entered by the Bidders would be encrypted using PKI encryption techniques to ensure the secrecy of the data. The data entered will not be viewable by unauthorized persons during Bid submission & not be viewable by any one until the time of Bid opening.
- 9.28 Any Bid document that is uploaded to the server is subjected to symmetric encryption using a system generated symmetric key. Further this key is subjected to asymmetric encryption using buyers/Bid openers' public keys. Overall, the uploaded Tender documents become readable only after the Tender opening by the authorized Bid openers.
- 9.29 The confidentiality of the Bids is maintained since the secured Socket Layer 128 bit encryption technology is used. Data storage encryption of sensitive fields is done.
- 9.30 The Bidder should logout of the Tendering system using the normal logout option available at the top right hand corner and not by selecting the (X) exit option in the browser.

9.31 Any queries relating to the Tender document and the Terms and Conditions contained therein should be addressed to the Tender Inviting Employer for a Tender or the relevant contact person indicated in the Tender.

9.32 Any queries relating to the process of online Bid submission or queries relating to CPP Portal in general may be directed to the 24x7 CPP Portal Helpdesk. The contact number for the helpdesk is 1800 233 7315.

Contact Telephone Numbers: 0120-2549856, 0120-4200462, 0120-4001002

10. Submission of Bids

The Hard Copy of original instruments in respect of cost of Tender document and Earnest Money Deposit must be delivered to the office of Member (Tech) , A-13, Sector-I, Gautama Buddha Nagar, Noida, U.P-201301, on or before Bid closing Date & Time. Bids submitted without original payment instrument like Tender document fee & EMD, against the submitted Bid shall automatically become ineligible and shall not be considered. Further, in case of MSME registered firms, letter of claim of exemption for EMD & Tender Fee with documentary evidence against the claim must be delivered to the office of Member (Tech) on or before Bid closing Date & Time.

The Technical and Financial Bids, complete in all respects, should be submitted as per sequence mentioned below. Bids should be submitted in Two Covers:

10.1 Cover-I: Technical Bid

10.1.1 Enclosure – I

- a. Scanned copy of the proof of Cost of Tender Document as specified in **Section – III: Data sheet**
- b. Scanned copy of the proof of EMD as specified **in Section – III: Data Sheet and Annex – VI** (if submitted in the form of BG)
- c. Proof of bank solvency for the amount as specified in **Section – III: Data Sheet**
- d. Power of Attorney for the authorised person of the bidder as per Form 4D. This form shall be accompanied by copy of company identity card or general identity card (passport/Driving licence/Voter's ID etc.) of the authorised representative.
- e. ~~Power of Attorney for lead member of the JV/Consortium as per **Form 4K**~~
- f. ~~Joint Bidding Agreement as per **Form 4M**~~

-
- g. Statement of legal Capacity as per **Form 4L**
 - h. Scanned copy of Tender Acceptance Letter duly filled and signed by the authorised signatory of the Bidder as per **Annex – V**
 - i. Scanned copy of Form of Tender (**Form 4A**)
 - j. Scanned copy of a signed declaration by the bidders (**Form 4G**)
 - k. Bidders Information Form (**Form 4H**)
 - l. Composition/Ownership/Shareholding pattern of the organization
 - m. Board Resolution, details of top management (Board members), key officials with documentary evidence, Articles of Association/memorandum of association of the company.
 - n. Registration/incorporation certificate of the company/Firm.
 - o. Original tender document with all addendums and corrigendum issued till date duly stamped and signed by the authorised signatory of the bidder.

10.1.2 Enclosure – II

- a. Scanned copy of the Annual Report/Audited balance sheets, for the last three financial years ending 31st March of the previous financial year i.e. 2021-22, 2022-23 and 2023-24.
- b. Scanned copy of GST Registration certificate.
- c. Scanned copy of PAN card of the Bidder.
- d. Income Tax Return (ITR) filed by the Bidder for the last three financial years i.e. 2021-22, 2022-23 and 2023-24..
- e. Form 4C of Section IV for average annual turnover
- f. Form 4O of Section IV for Bid Capacity.
- g. Scanned copy of Bank account details, along with a cancelled cheque, for transaction through e-payment in format given at **Annex- III & Annex - IV**.
- h. Integrity agreement

10.1.3 Enclosure – III

Scanned copy of complete Company profile with details such as:

-
- a. Background of the organization
 - b. Copies of completion certificate on client letter head for similar projects executed by the bidder in last seven years i.e (2017-18 to 2023-24). The submitted certificates shall comply to conditions laid in **Clause 3 of ITB** (Bidder Eligibility Criteria) Such eligible projects shall be supplied in **Form 4B of Section IV**
 - c. Copies of work order/agreement with value and status (% completed till submission) in case of on-going work shall be submitted separately as proof of on-going assignments as per Form- 4F of Section IV. The bidder shall also submit, along with Form – 4F, plan/provision to move the existing machinery to the project site when required.
 - d. General Construction experience of the bidder to be submitted as per **Form 4N**.
 - e. List of litigation history.

10.1.4 Enclosure – IV

- a. Scanned copies of following, keeping in view the scope of work listed in the ToR :
 - (i) GA Drawing and Construction methodology
 - (ii) Detailed work plan with bar-chart
 - (iii) List of Equipment to be deployed as per Form 4I of Section IV (Details of make and manufacture to be provided).
 - (iv) List of experts/key personnel (Form 4E of Section IV)

It may be noted that the Technical Bid shall not contain any reference to any fee or charges. Violation of this clause will lead to rejection of bid.

~~All the submissions enumerated under Enclosure II & III shall be submitted by all the JV Partners separately.~~

10.2 Cover-II: Financial Bid

Financial Bid in excel format (BoQ_1 and 2) provided along with this Tender as Form Fin – 2 shall be used for quoting prices/offer.

- (i) This will contain fixed price contract rate to be charged for completing the work.
- (ii) While working out the price, following points should be noted:

-
- (a) The Contractor will have bear the cost of mobilization of equipment to the floating jetty site and their demobilization as required. All other incidental cost during the work is also to be borne by the Bidder.
 - (b) The Contractors will have to make their own arrangements for the transport/accommodation/TA/DA of their personnel assigned to this project. The price quoted shall also include the Contractor's representative visit to various offices, and other places for meetings, data collection, presentations, public consultation, secretarial staff, their salary, allowances, overhead expenditure etc.
 - (c) All duties, taxes, royalties and other levies payable by the Contractor under the Contract, or for any other cause, shall be included in the rates, prices, and total Bid price submitted by the Bidder except for GST which will be as per existing rules and regulations at the time of payment. The rates and prices quoted by the Bidder shall be fixed for the duration of the Contract and shall not be subject to any adjustment. The prices shall be quoted by the Bidder entirely in Indian Rupees. All payments shall be made in Indian Rupees (INR).

10.3 In case there is a difference in submission made by the Bidder, online and in the submission made in hard copies, the online submission shall prevail over hard copy submission and the same shall be considered for evaluation.

10.4 The total duration of Works shall be as specified in **Section – III: Data Sheet**.

11. Extension of Bid submission date

The employer may extend the date of submission of bids by issuing an addendum and uploading the same in website.

12. Late Proposals

Proposals received by the employer after the specified bid submission date or any extension thereof, pursuant to clause 11, shall not be considered for evaluation and shall be summarily rejected.

13. Liability of the employer

The bidders are advised to avoid last moment rush to submit bids online and they should upload their bids well in advance before the bid submission deadline. The employer shall not be liable for failure of online submission of bids by the bidder that

may arise due to any reason whatsoever. It shall be construed that the guidelines for online submission of bids, mentioned under clause 9 of ITB, have been read and understood by the bidder. The hard copy of the bids submitted by the bidder shall not be treated as a substitute to online bids submission and in case a bidder fails to submit bids online due to any reason, the hard copies of the bids shall not be considered for evaluation.

14. Modification/Substitution/ Withdrawal of Bids

The tender once submitted may be modified, substituted or withdrawn by the bidders before the submission deadline through e-Procurement Mode as mentioned in NIT of this tender document.

No bid shall be modified after the deadline for submission of bids.

15. Bid opening and evaluation process

- 15.1 From the time the Proposals are opened to the time the Contract is awarded, the Bidders should not contact the Employer on any matter related to its Technical and/or Financial Proposal. Any effort by Bidders to influence the Employer in the examination, evaluation, ranking of Proposals, and recommendation for award of Contract may result in the rejection of the Bidders' Proposal.
- 15.2 The employer will constitute a tender evaluation committee (TEC) which will carry out the evaluation process.
- 15.3 Online Bid opening shall be carried out in two stages. Firstly, 'Technical Bid' of all the online Bids received shall be opened on the date and time mentioned in Section – III: Data Sheet. 'Financial Bid' of those Bidders whose Technical Bid has been determined to be responsive and on evaluation fulfils the criteria as stipulated in the Tender Document, shall be opened on a subsequent date, which will be notified to such Bidders. In the event of the specified date for the submission of bids being declared a holiday for The Employer, the Bids will be opened at the appointed time and location on the next working day. Bids for which a notice of withdrawal has been submitted shall not be opened.
- 15.4 The TEC shall evaluate the Technical Bids on the basis of their responsiveness to the Terms of Reference and by applying the evaluation criteria specified in Clause 16. Bid shall be rejected if it is found deficient or found not meeting the eligibility criteria

as mentioned in clause 3 and clause 16.1 of ITB. Only responsive bids shall be further taken up for evaluation. A Bid shall be considered responsive only if:

- 15.4.1 It is received by the Bid submission date and time including any extension thereof, pursuant to Clause 11;
- 15.4.2 It is accompanied by Tender Fee & Earnest Money Deposit' as specified in Clause 6.1 & 6.2 above;
- 15.4.3 It is received in the forms specified in section IV (Technical Proposal) and in section V (financial proposal);
- 15.4.4 It does not contain any condition or qualification
All the information shall be furnished by the Bidder in the requisite Forms sought in Section IV. Failure to submit the requisite Forms shall be treated as non-responsive and no further clarification shall be sought in this regard.
- 15.5 To assist in the examination, evaluation, and comparison of the bids, and qualification of the Bidders, the Employer may, at its discretion, ask any Bidder for a clarification of its bid, giving a reasonable time for response. Employer however, is not bound to accept the clarification submitted by the Bidder if found irrelevant. The Employer's request for clarification and the response shall be in writing.
- 15.6 The Employer shall inform the Bidders, whose Technical Bids are found responsive and on evaluation fulfils the criteria stipulated in the Tender document, of the Date, Time and Place of opening of the Financial Bids. The Bidders so informed, or their representative, may attend the meeting of online opening of Financial Bids.
- 15.7 At the time of the online opening of the 'Financial Bids', the names of the Bidders, whose Bids were found responsive and qualified for opening of financial bid, the total amount of each Bid, and such other details as the Employer may consider appropriate will be announced by the Employer at the time of Bid opening.
- 15.8 Bidder may, if deemed necessary by him, send a representative to attend the financial bid opening. Such representative shall have a letter of authorization from the bidder to attend the bid opening on its behalf. In case a bidder sends a representative on its behalf to attend the financial bid opening, it shall be construed that the representative has the authority of the bidder.

16. Qualification Criteria and Bid evaluation

16.1 Qualification criteria

To qualify for this tender, the Bidder must satisfy each of the qualifying criteria stipulated in Clauses 16.1.1 to 16.1.5 of ITB. Not satisfying any of the qualification

criteria will render the bid non-responsive and financial bids of such bidders will not be opened.

16.1.1 Qualification for works

The Bidder should have successfully completed "Similar Works" in previous 7 years before the last date of the Bid submission as per the criteria specified below:

- a) 3 similar works each costing not less than the amount equal to 40% of the estimated cost of this work i.e 14.25 Cr. or
- b) 2 similar works each costing not less than the amount equal to 50% of the estimated cost of this work i.e 17.81 Cr. or
- c) 1 similar work costing not less than the amount equal to 80% of the estimated cost of this work i.e 28.50 Cr.

Note: The value of the "Completed Work(s)" considered by the Bidders shall be rounded off to the nearest two digits.

- a) For this purpose, the "**Similar Works**" means design, construction, supply, installation, testing and commissioning of floating concrete Jetties duly certified by IR Class or any IACS body. In case, the work has been completed abroad, an Apostille certificate to this effect must be submitted.

~~In the event of a Joint Venture, all Parties combined shall together meet the technical eligibility as well as financial eligibility requirement.~~

Further, the value of contracts completed by its members shall not be aggregated to determine whether the requirement of the minimum value of a single contract has been met. Instead, each contract performed by each member shall satisfy the minimum value of a single contract as required for a single entity. In determining whether the JV meets the requirement of total number of contracts, only the number of contracts completed by all members, each of value, equal or more than the minimum value required shall be aggregated.

16.1.2 Qualification Criteria for Average annual turnover for last 3 financial years i.e. 2021-22, 2022-23 and 2023-24 should be at least Rs 10.68 Crore to qualify.

16.1.3 Qualification Criteria for Equipment and experience

- i. For minimum eligibility pertaining to equipment, the Bidder may refer clause 7 of ToR.

-
- ii. Details of pontoon / jetty design and construction work executed in last 7 years (i.e. 2017-18 to 2023-24), type of pontoon / jetty designed and constructed, quantity, scheduled period of execution, date of commencement and date of completion, and certificate/testimonials from the concerned clients regarding successful completion of the job and IACS body approval to substantiate technical capacity of the Bidder required as per Clause 3 and 16.1.1 of ITB.

16.1.4 Qualification Criteria for Bid capacity

- i. The Bidder shall submit the details asked for the Bid capacity as per the format prescribed in Form 4O.
- ii. The Bid Capacity of the Bidder must be equal to or more than the estimated cost of the work put to the Tender.
- iii. In case the Bid capacity of the Bidder is less than the estimated cost of the work for respective schedule, his bid shall be cancelled and such Bidder shall not be considered for opening of Financial Bid even if he has been determined eligible in other criteria's set forth in the Tender Document.
- ~~iv. In the event of a Joint Venture, all parties combined shall together meet the Qualification requirement of Bid Capacity.~~

16.1.5 Qualification Criteria for Work Plan and Methodology Statement

- i. The Bidder shall submit the work plan indicating the design, construction, supply, installation, testing and commissioning schedule in bar chart format.
- ii. The Bidder should have its own manufacturing facility (leased/Owned) for manufacturing floating concrete pontoons in India. The bidder shall also furnish the details manpower & equipment available with him, for the construction and installation of floating jetties.

16.2 Bid evaluation

16.2.1 The Bids shall be evaluated based on the qualification criteria mentioned in Clause 16.1 of ITB. In case a bidder fails to meet the above mentioned qualification criteria, their bids shall be treated as non-responsive and financial bids of such bidders shall not be opened.

16.2.2 A substantially responsive bid is one that conforms to all the terms, conditions, and specifications of the bidding document without material deviation or reservation. A material deviation or reservation is one:

- a) that affects in any substantial way the scope, quality, or performance of the Works;

-
- b) that limits in any substantial way, inconsistent with the bidding documents, the Employer's rights or the bidder's obligations under the contract; or
- c) whose rectification would affect unfairly the competitive position of other bidders presenting substantially responsive bids. Further, a bid will not be considered substantially responsive if the bidder has not offered to undertake all the items of the work as listed in Bill of Quantity (BoQ) of section V of bid document.
- 16.2.3 The estimated effect of the price adjustment provisions of the Conditions of Contract, applied over the period of execution of the Contract, shall not be taken into account while evaluating bids.
- 16.2.4 The lowest priced bidder i.e. L-1 shall be chosen based on the amount quoted by the bidders in BoQ of Section V.
- 16.2.5 If the bid, which results in the lowest Evaluated Bid Price, is seriously unbalanced or front loaded or back loaded as compared to the estimate of the items of work to be performed under the Contract, the bidder shall be asked to produce detailed price analyses for any or all items of the Bill of Quantities, to demonstrate the internal consistency of those prices with the construction methods and operating methodology proposed. After evaluation of the price analysis, taking into consideration the schedule of estimated Contract payments, price may be negotiated with the lowest bidder to remove the imbalance, make an appropriate adjustment on sound technical and/or financial ground for any quantifiable, acceptable aspects and thereby bring the prices to justified level sufficient to protect the Employer's interest, before taking a decision on the bid.
- 16.2.6 If during the execution of the works, deviation / variation takes place to the extent of amount exceeding more than 20% of the accepted contract value, the Contractor at the written request of Engineer-In-Charge, shall promptly increase the value of the Performance Bank Guarantee.

17. Award of Contract

- 17.1 The Employer shall issue a Letter of Award to the selected Bidder. It may also notify all other Bidders who submitted their bids about the decision taken.
- 17.2 ~~For a Joint Venture Bidder, the Contractor will sign the contract after fulfilling all the formalities/pre conditions mentioned in the Standard Form of Contract in Section VII, within 45 days of issuance of the Letter of Award.~~ In case of Single

Entity Bidder, the contract will be signed within 28 days of issuance of the Letter of Award.

- 17.3 The Contractor is expected to commence the Assignment/job on the date and at the location specified in Section III Data Sheet.

18. Mobilization of Equipment, Men & Materials

18.1 Mobilization Site

The Contractor shall mobilize all the equipment, materials and manpower at site as required for the work for providing floating terminal facilities and as specified in Clause 18 of Data Sheet.

18.2 Mobilization Time

The Contractor shall mobilize the desired equipment and manpower within the time frame as specified in Clause 19 of Data Sheet to start the works of Design, construction, supply, installation, and facilities in full capacity.

19. Ownership of Document and Copyright

All the deliverables and study outputs including primary data shall be compiled, classified and submitted by the Contractor to the Employer in hard copies and editable soft copies in addition to the requirements for the reports and deliverables indicated in the Terms of Reference.

The study outputs shall remain the property of the Employer and shall not be used for any purpose other than that intended under these Terms of Reference without the prior written permission of the Employer. In the case of any deliverables by Contractor consisting of any Intellectual Property Rights ("IPR") rights of the Contractor, the Contractor shall provide the Employer with necessary irrevocable royalty-free license to use such IPR. Further, for the avoidance of any doubt, it is clarified that any intellectual property developed during the course of, or as a result of, the services rendered in relation to the Works, shall be and shall remain property of the Employer.

SECTION - III: DATA SHEET

DATA SHEET

CLAUSE NO. OF DATA SHEET	REF OF ITB	PARTICULARS	DESCRIPTION
1.	Section-I 1.1	Employer	The Chairman, Inland Waterways Authority of India (IWAI), A-13, Sector-1, Noida-201301
2.	Section-I 1.1	Name of the Assignment/job is	"Design, construction, supply installation, testing and commissioning of 10 nos. Concrete Jetties in New National Waterways in J&K".
3.	1.4	Method of Selection	CBS (Cost Based Selection) – L1
4.	2.3	Date & time and address for submission of Bid	Date : 01.04.2025 Time: 1530 hrs Submission: online submission Address: Member(Tech), Inland Waterways Authority of India (IWAI), A-13, Sector-1, Noida-201301
5.	Section –II Clause -4	A pre-Bid in Hybrid mode will be held on	Date : 11.03.2025 Time : 1500 hrs Venue: Inland Waterways Authority of India (IWAI), A-13, Sector-1, Noida-201301
6.	5.1	Last date for seeking clarifications	Date : 10.03.2025 @ 1500 hrs Email Id: mt.iwai@nic.in , ssingh@iwai.gov.in , srafat.iwai@nic.in , ppolagani.iwai@nic.in , rpatel@iwai.gov.in
7.	6.1	EMD	INR 71.25 lakh
8.	6.2	Cost of Tender Document	INR 5,900/- (incl. GST).
9.	6.3	Bank Solvency	INR 14.25 Cr.
10.	16.1.2	Average Annual Turnover	INR 10.68 Cr.
11.	6.7	Bid Validity	120 days after Bid submission date

CLAUSE NO. OF DATA SHEET	REF OF ITB	PARTICULARS	DESCRIPTION
12.	3.3	Similar Works	As stipulated in Clause 16.1.1 of ITB
13.	-	JV/consortium allowed	Not allowed
14.	3.7	The estimated number of Key Personnel Required	As per Form 4E
15.	-	The formats for the Technical Bid	FORM 4A: Form of Tender FORM 4B: Eligible Projects FORM 4C: Average Annual Turnover FORM 4D: Power of Attorney (for authorized representative of the bidder) FORM 4E: List of Key Personnel FORM 4F: List of On-going assignments FORM 4G: Declaration by the Bidders FORM 4H: Applicant's Party Information Form FORM 4I: Availability of infrastructural facility, equipment, machineries etc. to be used for tender work FORM 4J: Format for pre-bid queries FORM 4K: Power of Attorney for Lead Member of JV/Consortium FORM 4L: Statement of Legal Capacity FORM 4M: Joint Bidding Agreement FORM 4N: General Construction Experience FORM 4O: Bid Capacity
16.	10.4	Contract Duration	5 months from the date of signing of agreement excluding Defects Liability Period of 12 months.
17.	15.3	Bid Opening date	Date : 02.04.2025 Time : 15:30 hrs Venue : IWAI, A-13, Sector – 1, Noida
18.	18.1	Mobilization Site	State of Jammu & Kashmir
19.	18.2	Mobilization Time	15 days from the approval of Design/drawing from NTCPWC.
20.	-	Price Preference	Since Splitting of scope / quantity of work is not feasible keeping in view the nature of work involved, price preference clause

CLAUSE NO. OF DATA SHEET	REF OF ITB	PARTICULARS	DESCRIPTION
			for MSE registered firms/ bidders will not be applicable.
21.	-	Make in India	As per policy of Govt. of India to promote Make in India, the provisions vide order no. P-45021/2/2017-B.E-II dated 15.06.2017 on the subject "Public procurement (preference to Make in India)" shall be applicable to the extent possible.
22.	-	Start-up India	Eligible as per extant directives of GoI

SECTION-IV: TECHNICAL BID STANDARD FORMS

FORM 4A: Form of Tender

To

The Member(Tech)
INLAND WATERWAYS AUTHORITY OF INDIA,
A-13, Sector-1, NOIDA- 201 301, U.P.

Sub: Design, construction, supply installation, testing and commissioning of 10 nos. Concrete Jetties in New National Waterways in J&K.

Sir,

1. Having visited the site and examined the information and instructions for submission of tender, General Conditions of Contract (GCC), Special Conditions of Contract (SCC), Technical, General and Detailed specifications, Bill of Quantities (BoQ) agreement and bank guarantee forms, etc. for the above named works, I/ We(Name of Bidder) hereby tender for execution of the works referred to in the tender document in conformity with the said GCC, SCC, Schedule of quantities for the sum as stated in BoQ of this tender document or such other sum as may be ascertained in accordance with the said conditions of contract.
2. I/ We undertake to complete and deliver the whole of the works comprised in the Contract within the time as stated in the tender and also in accordance in all respects with the specifications, Scope of work and instructions as mentioned in the tender document.
3. I am tendering for the works mentioned in the table below and submitting the EMD vide RTGS / NEFT/ BG in IWAI Account as per the details given therein:

S. No.	RTGS / NEFT		Bank Guarantee		Total EMD (INR)
	Amount (INR)	Details of RTGS / NEFT (No. and Date) and details of the bank (Name of bank, branch, address)	Amount (INR)	Details of the Bank Guarantee (No and Date) and details of the bank (Name of bank, branch, address)	
1					

-
4. I/ We agree to abide by this tender. I/ We agree to keep the tender open for a period of 120 days from the last date of Bid Submission or extension thereto as required by the IWAI and not to make any modifications in its terms and conditions.
 5. I/ We agree, if I/ we fail to keep the validity of the tender open as aforesaid or I/ we make any modifications in the terms and conditions of my/ our tender if I/ We fail to commence the execution of the works as above, I/ We shall become liable for forfeiture of my/ our Earnest money, as aforesaid and IWAI shall without any prejudice to another right or remedy, be at the liberty to forfeit the said Earnest Money absolutely otherwise the said earnest money shall be retained by IWAI towards part of security deposit to execute all the works referred to in the tender document upon the terms and conditions contained or referred to therein and to carry out such deviations as may be ordered. Should this tender be accepted, I/ We agree(s) to abide by and fulfil all the terms and conditions and provisions of this tender. No interest is payable on earnest money deposit and/ or security deposit.
 6. I/ We have independently considered the amount of Liquidated Damages shown in the tender hereto and agree that it represents a fair estimate of the loss likely to be suffered by IWAI in the event of works not being completed in time.
 7. If this tender is accepted, I/ We undertake to enter into execute at my/ our cost when called upon by the employer to do so, a contract agreement in the prescribed form. Unless and until a formal Agreement is prepared and executed this tender together with your written acceptance thereto shall constitute a binding contract.
 8. If my/ our tender is accepted, I/We am/are to be jointly and severally responsible for the due performance of the Contract. **I/We also declare that the firm has not been banned or blacklisted by any Govt. or its department or any Quasi Govt. agency or Public Sector Undertaking or Multilateral or International Aid Agency/Development Bank.** Any such discovery by IWAI at any stage of the tender/contract may result in disqualification of the firm or cancellation of the contract.
 9. I/ We understand that you are not bound to accept the lowest or any tender you may receive and may reject all or any tender without assigning any reason.

10. I/ We certify that the tender submitted by me, us is strictly in accordance with the terms, conditions, specifications etc. as contained in the tender document, and it is further certified that it does not contain any deviation to the aforesaid documents.

Date

Signature

Name

Designation

duly authorized to sign & submit tender for an
on behalf of

(Name and address of firm)

M/s

Telephone no's.....FAX No.....

FORM 4B: Eligible Projects

Format for Responsiveness of Bid (Eligible Projects) Project Specific Experience

[Using the format below, provide information on each assignment for which your firm, and each associate for this assignment, was legally contracted either individually or as a corporate entity or as one of the major companies within an ~~Joint Venture (JV) for carrying similar works under this assignment.~~]

“Similar Works¹” have been defined in Clause 16.1.1 (b) of ITB

S. No.	Client Name ² , Name of work & location of project	Contract Value in INR	Date of start of work	Scheduled completion date	Actual completion date	Details of work (including Similar Work)	Remarks
		Financial ³ value of similar work satisfactorily completed					

Firm's Name :

Authorized Signature :

¹ Exhibit only those projects completed in the last Seven (7) years i.e. 2015-16 to 2021-22 from the **Last Date of Bid Submission**.

² The Bidder shall submit proof of experience from the Client for meeting the minimum qualification details. The Client Certificate submitted by the Client shall contain the details as enlisted in Clause 3.2 of ITB. The works claimed by the Bidder, if not supported with proof of completion as laid down under Clause 3.2 of ITB from the Client will not be considered.

³ Against the Contract of works having several components other than the Similar Works, only the relevant component shall be evaluated for contract value, payment value and the actual execution period for the relevant component only should be submitted / specified.

Notes:

1. For the purpose of evaluation, Bidders should assume 7% inflation for Indian Rupees every year and 2% for foreign currency portions per year compounded annually.
2. Bidders should mention the maximum value of similar works as defined in Clause 16.1.1 of ITB executed during the last seven years i.e. 2016-17 to 2022-23 (adjusted last day of the month previous to the one in which this Tender is invited).
3. In case of foreign currency, it should first be escalated at the rate mentioned above and then the amount so derived shall be converted to INR at the exchange rate prevailing last day of the month previous to the one in which this Tender is invited.
4. Exchange rate should be taken from official website of RBI (<https://www.rbi.org.in/scripts/ReferenceRateArchive.aspx>)
5. In case, exchange rate for the currency in consideration, is not available on RBI website (mentioned above), Bidders shall quote exchange rates from websites such as www.xe.com, www.oanda.com, along with copy of the exchange rate used by the Bidder for the conversion.
6. Any additional comments / information to substantiate that the said work conforms to the specified similar works can also be indicated by the bidder, as deemed fit.

Please limit the description of each project in two A4 size sheet of paper. Descriptions exceeding two (02) A4 size sheet of paper may or may not be considered for evaluation.

FORM 4C: Average Annual Turnover of the Bidder

Sl. No.	Financial Years	Average Annual Turnover of Applicant (INR) in Last Three Years
1.	2021-22	
2.	2022-23	
3.	2023-24	
Average Annual Turnover		[indicate sum of the above figures divided by 3]

Certificate from the Statutory Auditor

This is to certify that..... *[Name of the Firm][Registered Address]* has received the payments shown above against the respective years.

Name of Authorized Signatory

Designation:

Name of Firm:

(Signature of the Statutory Auditor Seal of the Firm)

Note:

1. In case the Consultant does not have a statutory auditor, it may provide the certificate from a practicing chartered accountant.
2. This Form shall be submitted on the letter head of the CA / Statutory Auditor

FORM 4 D: Power of Attorney

(for authorized representative of the bidder)

(To be executed on Non-Judicial Stamp Paper of Rs.100 and duly notarized)

Know all men by these presents, We,(name of organization and address of the registered office) do hereby constitute, nominate, appoint and authorise Mr./Ms.son/daughter/wife and presently residing at ... who is presently employed with/retained by us and holding the position of, as our true and lawful attorney (hereinafter referred to as the "**Authorised Representative**"), with power to sub-delegate to any person, to do in our name and on our behalf, all such acts, deeds and things as are necessary or required in connection with or incidental to submission of our Bid for Design, construction, supply installation, testing and commissioning of 10 nos. Concrete Jetties in New National Waterways in J&K. The selection of Contractor for Inland Waterways Authority of India (the "**Employer**") including but not limited to signing and submission of all applications, Bids and other documents and writings, participating in pre-bid and other conferences and providing information/responses to the Employer, representing us in all matters before the Employer, signing and execution of all contracts and undertakings consequent to acceptance of our Bid and generally dealing with the Employer in all matters in connection with or relating to or arising out of our Bid for the said Project and/or upon award thereof to us till the entering into of the Contract with the Employer.

AND, we do hereby agree to ratify and confirm all acts, deeds and things lawfully done or caused to be done by our said Authorised Representative pursuant to and in exercise of the powers conferred by this Power of Attorney and that all acts, deeds and things done by our said Authorised Representative in exercise of the powers hereby conferred shall and shall always be deemed to have been done by us.

IN WITNESS WHEREOF WE, THE ABOVE NAMED PRINCIPAL HAVE EXECUTED THIS POWER OF ATTORNEY ON THIS... DAY OF....., 20**

For ...

(Signature, Name, Designation and Address) Witnesses:

1.....

2.

Accepted

(Signature, name, designation and address of the Attorney)

Notes:

- 1. The mode of execution of the Power of Attorney should be in accordance with the procedure, if any, laid down by the applicable law and the charter documents of the executant(s) and when it is so required the same should be under common seal affixed in accordance with the required procedure.*
- 2. Wherever required, the Applicant should submit for verification the extract of the charter documents and other documents such as a resolution / power of attorney in favour of the person executing this Power of Attorney for the delegation of power hereunder on behalf of the Applicant*
- 3. For a Power of Attorney executed and issued overseas, the document will also have to be legalised by the Indian Embassy and notarised in the jurisdiction where the Power of Attorney is being issued. However, the Power of Attorney provided by Applicants from countries that have signed The Hague Legislation Convention, 1961 are not required to be legalised by the Indian Embassy if it carries a conforming Apostille certificate.*

FORM 4E: List of Key Personnel

Sr. No.	Position / Role	No.

Note:

1. The list of key personnel is tentative and indicative only. The Bidder can propose the key personal required for works as per the scope defined in the Tender Document.
2. During the tenure of contract if need arise, then the Bidder is allowed to change / replace the Key Personnel with a prior written approval from EIC.

FORM 4F: List of Ongoing Assignments

S I. N o .	Full Postal Address of Client & Name of officer- in- charge	Description of the work	Total Contract Value	Value of the work completed till last date of the previous month from the Bid Submission Date	Outstanding / Balance Value of the work till last date of the previous month from the Bid Submission Date	Date of commenc- ement of work	Scheduled completion period	Average completion as on date	Expect- ed date of com- pletion

FORM 4G: Declaration by the Bidders

Date:.....

To,

The Member(Tech)
INLAND WATERWAYS AUTHORITY OF INDIA,
A-13, Sector – 1, Noida - 201 301,
District- Gautam Buddha Nagar (U.P.)

Sub: Declaration from the Bidder.

Tender Reference No:.....

Dear Sir,

This is with reference to the above mentioned Tender document.

I/We hereby make the following declarations:

1.	<input type="checkbox"/>	No alteration has been made in any form in the downloaded Tender document.
2.	<input type="checkbox"/>	I/We have not been banned or de listed by any Government or quasi Government agency or public sector undertaking.
3.	<input type="checkbox"/>	I/We accept the payment terms of clause 15.2 of General Conditions of Contract.
4.	<input type="checkbox"/>	I/We provide our acceptance to all Tender Terms and Conditions.
5.	<input type="checkbox"/>	Acknowledgment by Bidder as per Clause 8 of ITB
6.	<input type="checkbox"/>	I/We confirm that neither we have failed nor we have been expelled from any project or agreement during the last 03 years
7.	<input type="checkbox"/>	I/We agree to disqualify us for any wrong declaration with respect to the submissions made by us for this tender and reject my/our tender summarily
8.	<input type="checkbox"/>	I/We agree to disqualify us from this tender and black list us for tendering in IWAI projects in future, if it comes to the notice of IWAI that the documents/submissions made by me/us are not genuine
9.	<input type="checkbox"/>	I / We confirm that I/we have noted / updated ourselves of all amendments / corrigendum / response to pre-submission queries etc. and bid is submitted incorporating the same.

Yours Faithfully
(Signature of the Bidder, with Official Seal)

FORM 4H: Bidders Information Form

Bidder name:

[insert full name]

Bidder's Party name:

[insert full name of Applicant's Party]

Bidder's Party country of registration:

[indicate country of registration]

Bidder's year of constitution:

[indicate year of constitution]

Bidder's legal address in country of constitution:

[insert street/ number/ town or city/ country]

Bidder's authorized representative information

Name: *[insert full name]*

Address: *[insert street/ number/ town or city/ country]*

Telephone/Fax numbers: *[insert telephone/fax numbers, including country and city codes]*

E-mail address: *[indicate e-mail address]*

1. Attached are copies of original documents of

- Articles of Incorporation (or equivalent documents of constitution or association), and/or registration documents of the legal entity named above
- In case of a Government-owned enterprise or institution, documents establishing legal and financial autonomy, operation in accordance with commercial law, and absence of dependent status

2. Included are the organizational chart, a list of Board of Directors, and the beneficial ownership.

Note:

This Form shall be supplied with Identity proof of the authorized representative

**FORM 4I: Availability of infrastructural facility,
equipment, machineries etc. to be used for tender work.**

Name & Address of the Ship Builder	Detailed Particulars
(i) Fabrication/construction bays (details including number, dimension, location to be given). Whether covered or open)	
(ii) Skids / Mould loft for modular construction (details including number, dimension and location to be given). Whether covered or open.	

(Signature of authorized representative)

FORM 4J: Format for Pre bid queries by Bidders
(To be submitted in Bidders Letter head)

Name of Bidder:
Date of Submission:

Pre – Bid Queries

S. No.	Section No. Clause, Sub Clause No and Page No. of Tender	Tender clause description	Query
1.			
2.			
3.			
4.			
5.			
6.			

**FORM 4K: Power of Attorney for Lead Member of
JV/Consortium- Not applicable**

(To be executed on Non-Judicial Stamp Paper of Rs.100 and duly notarised. For a Power of Attorney executed and issued overseas, the document will also have to be legalised by the Indian Embassy and notarized in the jurisdiction where the undertaking is being issued.)

Whereas the Inland Waterways Authority of India (the "Authority") has invited Bids from interested parties for the ~~"Design, construction, supply installation, testing and commissioning of 10 nos. Concrete Jetties in New National Waterways in J&K. (hereinafter referred to as~~ "The Work")" and Whereas,

.....and (collectively
..... the

~~"JV/Consortium") being Members of the JV/Consortium are interested in bidding for the Project in accordance with the terms and conditions of the tender document and other connected documents in respect of the Project, and~~

Whereas, it is necessary for the Members of the JV/Consortium to designate one of them as the Lead Member with all necessary power and authority to do for and on behalf of the JV/Consortium, all acts, deeds and things as may be necessary in connection with the JV/Consortium's Bid for the Project and its execution.

NOW THEREFORE KNOW ALL MEN BY THESE PRESENTS

We,having our registered office at, M/s.
..... having our registered office at, M/s.
..... having our registered office at, and
..... having our registered office at, (hereinafter collectively referred to as the "Principals") do hereby irrevocably designate, nominate, constitute, appoint and authorise M/s having its registered office at, being one of the Members of the JV/Consortium, as the Lead Member and true and lawful attorney of the JV/Consortium (hereinafter referred to as the "Attorney"). We hereby irrevocably authorise the Attorney (with power to sub-delegate) to conduct all business for and on behalf of the JV/Consortium and any one of us during the bidding process and, in the event the JV/Consortium is awarded the contract, during the execution of the Project and in this regard, to do on our behalf and on behalf of the

~~JV/Consortium, all or any of such acts, deeds or things as are necessary or required or incidental to the pre qualification of the JV/Consortium and submission of its Bid for the Project, including but not limited to signing and submission of all, Bid and other documents and writings, participate in bidders and other conferences, respond to queries, submit information/ documents, sign and execute contracts and undertakings consequent to acceptance of the Bid of the JV/Consortium and generally to represent the JV/Consortium in all its dealings with the Authority, and/ or any other Government Agency or any person, in all matters in connection with or relating to or arising out of the JV/Consortium's Bid for the **"The Work"**.~~

~~AND hereby agree to ratify and confirm and do hereby ratify and confirm all acts, deeds and things done or caused to be done by our said Attorney pursuant to and in exercise of the powers conferred by this Power of Attorney and that all acts, deeds and things done by our said Attorney in exercise of the powers hereby conferred shall and shall always be deemed to have been done by us/ Consortium and shall be legally binding upon us/Consortium.~~

~~IN WITNESS WHEREOF WE THE PRINCIPALS ABOVE NAMED HAVE EXECUTED THIS~~

~~POWER OF ATTORNEY ON THIS DAY OF 20**~~

~~For (Signature)
..... (Name & Title)~~

~~For (Signature)
..... (Name & Title)~~

~~For (Signature)
..... (Name & Title)~~

~~Witnesses:~~

~~____ 1. ____
____ 2. ____~~

~~.....
(Executants)~~

~~(To be executed by all the Members of the JV/Consortium)~~

Notes:

- ~~The mode of execution of the Power of Attorney should be in accordance with the procedure, if any, laid down by the applicable law and the charter documents of the executants and when it is so required, the same should be under common seal affixed in accordance with the required procedure.~~
- ~~Also, wherever required, the Bidder should submit for verification the extract of the charter documents and documents such as a board or shareholders' resolution/ power of attorney in favour of the person executing this Power of Attorney for the delegation of power hereunder on behalf of the Bidder.~~
- ~~For a Power of Attorney executed and issued overseas, the document will also have to be legalised by the Indian Embassy and notarised in the jurisdiction where the Power of Attorney is being issued. However, the Power of Attorney provided by Bidders from countries that have signed the Hague Legislation Convention 1961 are not required to be legalised by the Indian Embassy if it carries a conforming Apostil certificate.~~

~~FORM 4L: Statement of Legal Capacity Not applicable~~
(To be forwarded on the letterhead of the Bidder/ Lead Member of JV/Consortium)

Ref. Date:

To,
Member (Tech)
Inland Waterways Authority of India
A-13, Sector 1,
NOIDA-201 301
Uttar Pradesh
India

Dear Sir,

~~We hereby confirm that we/ our members in the JV/Consortium (constitution of which has been described in the Bid) satisfy the terms and conditions laid out in the tender document.~~

~~We have agreed that (insert member's name) will act as the Lead Member of our JV/consortium.*~~

~~We have agreed that (insert individual's name) will act as our representative/ will act as the representative of the consortium on its behalf* and has been duly authorized to submit the tender document. Further, the authorised signatory is vested with requisite powers to furnish such letter and authenticate the same. All actions/representations of the Lead Member/Authorised Signatory shall be legally binding on the Consortium.~~

Thanking you,

Yours faithfully,

(Signature, name and designation of the authorised signatory)

For and on behalf of.....

**Please strike out whichever is not applicable.*

FORM 4M: Joint Bidding Agreement- Not applicable

(To be executed on Stamp paper of appropriate value)

~~THIS JOINT BIDDING AGREEMENT is entered into on this the day of 20...~~

AMONGST

1. ~~{..... Limited, a company incorporated under the Companies Act, 1956} and having its registered office at (Hereinafter referred to as the "First Part" which expression shall, unless repugnant to the context include its successors and permitted assigns)~~

AND

2. ~~{..... Limited, a company incorporated under the Companies Act, 1956} and having its registered office at (Hereinafter referred to as the "Second Part" which expression shall, unless repugnant to the context include its successors and permitted assigns)~~

AND/OR

3. ~~{..... Limited, a company incorporated under the Companies Act, 1956} and having its registered office at (Hereinafter referred to as the "Third Part" which expression shall, unless repugnant to the context include its successors and permitted assigns)~~

~~The above mentioned parties of the FIRST, SECOND and THIRD PART are collectively referred to as the "Parties" and each is individually referred to as a "Party"~~

WHEREAS,

(A) ~~Inland Waterways Authority of India (the "Authority"), has invited Bids (the "Bids") by its Request for Bid dated (The "tender Document" for "Design, construction, supply installation, testing and commissioning of 10 nos. Concrete Jetties in New National Waterways in J&K." (The "Work"))~~

(B) ~~The Parties have read and understood the TENDER Document and are interested in jointly bidding for the Project as members of a JV/Consortium and in accordance~~

~~with the terms and conditions of the TENDER document and other TENDER documents in respect of the Project, and~~

- (C) ~~It is a necessary condition under the TENDER document that the members of the JV/Consortium shall enter into a Joint Bidding Agreement and furnish a copy thereof with the Bid.~~

~~NOW IT IS HEREBY AGREED as follows:~~

~~1. Definitions and Interpretations~~

~~In this Agreement, the capitalised terms shall, unless the context otherwise requires, have the meaning ascribed thereto under the TENDER.~~

~~2. JV/Consortium~~

~~2.1 The Parties do hereby irrevocably constitute a JV/consortium, _____ (Name of JV, separate entity from partners) for the purposes of jointly participating in the Bidding Process for the Project.~~

~~2.2 The Parties hereby undertake to participate in the Bidding Process only through this JV/Consortium and not individually and/ or through any other JV/consortium constituted for this Project, either directly or indirectly or through any of their Associates.~~

~~3. Covenants~~

~~The Parties hereby undertake that in the event the JV/Consortium is declared the Preferred Bidder and awarded the Project, it shall incorporate a wholly owned special purpose company under the provisions of Indian Companies Act, 1956, as the O&M Contractor; in whose subscribed and paid up capital, the Preferred Bidder i.e. the parties herein shall collectively hold 100% equity during the License Period.~~

~~4. Role of the Parties~~

~~The Parties hereby undertake to perform the roles and responsibilities as described below:~~

- ~~(a) Party of the First Part shall be the Lead member of the JV/Consortium and shall have the power of attorney from all Parties for conducting all business for and on behalf of the JV/Consortium during the Bidding Process and until~~

~~the signing of the tender for "The Work" when all the obligations shall become effective;~~

~~(b) Party of the Second Part shall be assisting the Lead member in the manner as recorded herein for carrying out the entire scope of work awarded under the tender for "The Work". Notwithstanding anything contained in this agreement, party of the second part shall not be absolved of any of its obligations /liabilities/responsibilities merely because party of the first part has been designated as the lead member, and shall be individually equally liable / responsible to the same extent as the Lead Member.~~

~~(c) Parties shall jointly and severally endeavour to carry out the works, if awarded to them pursuant to the bidding process conducted by the Authority, in accordance with the terms and conditions specified in the TENDER Documents and such other agreements/Contracts/Work Orders as may be executed from time to time between the Authority and the JV/Consortium's Special Purpose Company.~~

~~5. Joint and Several Liabilities~~

~~The Parties do hereby undertake to be jointly and severally responsible for all obligations and liabilities relating to the Project and in accordance with the terms of the TENDER and the tender for "The Work, till such time as prescribed in accordance with the tender for "The Work".~~

~~6. Shareholding~~

~~6.1 The Lead Member of such Preferred Bidder JV/consortium shall at all time during the License Period hold equity equivalent to(as per clause 6.9.2) of the subscribed and paid up capital in the special purpose company incorporated by the parties to work as the contractor. Further, other consortium members whose technical/financial eligibility shall have been used for the purpose of qualification under this TENDER shall hold(as per clause 6.9.3) equity in the subscribed and paid up capital contractor during the License Period; Provided however that Authority may in its sole and absolute discretion permit a JV/consortium member to divest [in full/partially] its equity shareholding in the subscribed and paid up capital of the contractor.~~

~~6.2~~ The Parties undertake that they shall comply with all equity lock in requirements set forth in the tender for **"The Work"**.

~~7.~~ **Representation of the Parties**

Each Party represents to the other Parties as of the date of this Agreement that:

- ~~(a) Such Party is duly organized, validly existing and in good standing under the laws of its incorporation and has all requisite power and authority to enter into this Agreement;~~
- ~~(b) The execution, delivery and performance by such Party of this Agreement has been authorized by all necessary and appropriate corporate or Governmental action and a copy of the extract of the charter documents and board resolution/ power of attorney in favour of the person executing this Agreement for the delegation of power and authority to execute this Agreement on behalf of the Consortium Member is annexed to this Agreement, and will not, to the best of its knowledge:
 - ~~(i) Require any consent or approval not already obtained;~~
 - ~~(ii) Violate any Applicable Law presently in effect and having applicability to it;~~
 - ~~(iii) Violate the memorandum and articles of association, by laws or other applicable organizational documents thereof;~~
 - ~~(iv) Violate any clearance, permit, concession, grant, license or other Governmental authorization, approval, judgment, order or decree or any mortgage agreement, indenture or any other instrument to which such Party is a party or by which such Party or any of its properties or assets are bound or that is otherwise applicable to such Party; or~~
 - ~~(v) Create or impose any liens, mortgages, pledges, claims, security interests, charges or Encumbrances or obligations to create a lien, charge, pledge, security interest, encumbrances or mortgage in or on the property of such Party, except for encumbrances that would not, individually or in the aggregate, have a material adverse effect on the financial condition or prospects or business of such Party so as to prevent such Party from fulfilling its obligations under this Agreement;~~~~

- ~~(c) This Agreement is the legal and binding obligation of such Party, enforceable in accordance with its terms against it; and~~
- ~~(d) There is no litigation pending or, to the best of such Party's knowledge, threatened to which it or any of its Affiliates is a party that presently affects or which would have a material adverse effect on the financial condition or prospects or business of such Party in the fulfilment of its obligations under this Agreement.~~
- ~~(e) Such Party has read and understood the tender Documents and is executing this Agreement for the purposes as recorded hereinabove out of its own free will;~~

~~8. Termination~~

~~This Agreement shall be effective from the date hereof and shall continue in full force and effect at all times during the subsistence of the tender for "The Work" is achieved under and in accordance with the tender for "The Work" in case the Project is awarded to the JV/Consortium. However, in case the JV/Consortium is either not prequalified for the Project or does not get selected for award of the Project, the Agreement will stand terminated in case the Bidder is not pre-qualified or upon return of the Bid Security by the Authority to the Bidder, as the case may be.~~

~~9. Miscellaneous~~

~~9.1 This Joint Bidding Agreement shall be governed by laws of India.~~

~~9.2 The Parties acknowledge and accept that this Agreement shall not be amended by the Parties without the prior written consent of the Authority.~~

~~IN WITNESS WHEREOF THE PARTIES ABOVE NAMED HAVE EXECUTED AND DELIVERED THIS AGREEMENT AS OF THE DATE FIRST ABOVE WRITTEN.~~

~~SIGNED, SEALED AND DELIVERED~~

~~For and on behalf of the LEAD MEMBER~~

~~(Signature)~~

~~(Name)~~

~~(Designation)~~

~~(Address)~~

~~SIGNED, SEALED AND DELIVERED~~

~~For and on behalf of _____ For and on behalf of SECOND PART~~

~~(Signature)~~

(Name)

(Designation)

(Address)

For and on behalf of _____ For and on behalf of THIRD PART

(Signature)

(Name)

(Designation)

(Address)

In the presence of:

1) _____

2) _____

Notes:

- ~~The mode of the execution of the Joint Bidding Agreement should be in accordance with the procedure, if any, laid down by the Applicable Law and the charter documents of the executant(s) and when it is so required, the same should be under common seal affixed in accordance with the required procedure.~~
- ~~Each Joint Bidding Agreement should attach a copy of the extract of the charter documents and documents such as resolution / power of attorney in favour of the person executing this Agreement for the delegation of power and authority to execute this Agreement on behalf of the Consortium Member.~~
- ~~For a Joint Bidding Agreement executed and issued overseas, the document shall be legalised by the Indian Embassy and notarized in the jurisdiction where the Power of Attorney has been executed.~~

FORM 4N: General Construction Experience

(Each Bidder or member of a JV must fill in this form)

Name of the Bidder / Members JV Consortium:

General Experience				
Contract Identification and Name Name and Address of Employer Brief Description of the similar Works Executed by the Bidder	Starting Month /Year	Ending Month/ Year	Years	Role of Bidder

FORM 40: Bid Capacity

Eligibility and Qualification Criteria	Compliance Requirements			Documentation
	Single Entity	Joint Venture (existing or intended)		Submission requirements
		Member 1	Member 2	
Available Bid Capacity should be More than value of contract/ contracts applied for				Form 4F & Form 4N

Bid Capacity= [(A*N*2)-B], where

A= Maximum value of works executed in any one year during the last five years 2016-17 to 2021-22) (updated to the current price level), in INR

B= Value at current price level of the existing commitments and ongoing works to be completed during the period of completion of work for which the bids have been invited

N= No. of years prescribed for completion of works for which bids are invited (i.e. 1).

SECTION - V: FINANCIAL BID STANDARD FORMS

Form Fin – 1: Financial Bid Submission Form

[Location, Date]

To:

[Name and address of Employer]

Dear Sir:

We, the undersigned, offer to provide the services for the Assignment/Job for *[Insert title of Assignment/Job]* in accordance with your Request for Bid dated *[Insert Date]* and our Technical Bid. Our attached Financial Bid is for the sum of *[Insert amount(s) in words and figures]*. This amount is inclusive of all types of taxes excluding GST *[Insert amount(s) in words and figures]*. We hereby confirm that the financial Bid is unconditional and we acknowledge that any condition attached to financial Bid shall result in rejection of our financial Bid.

Our Financial Bid shall be binding upon us subject to the modifications resulting from Contract negotiations, up to expiration of the validity period of the Bid, i.e. before the date indicated inclause...

We understand you are not bound to accept any Bid you receive.

We remain,

Yours sincerely,

Authorized Signature [In Full and initials]:

Name and Title of Signatory :

Name of Firm :

Form Fin – 2: Summary of Cost

(All amount in INR)

(To Be Quoted Online)

I. BoQ 1

Sr. No.	Particulars	Amount
1.	Design, construction, supply installation, testing and commissioning of 10 nos. Concrete Jetties in New National Waterways in J&K.	(To be Quoted Online)
2.	CAMC for 10 nos. Jetties for 10 years	(To be Quoted Online)
3.	GST as applicable	
Total		

During Financial Bid Evaluation, for selection of lowest Bidder, quoted cost excluding GST would be considered. However, GST would remain effective as per the Government Guidelines, which shall be paid as per the provisions effective at the time of release of payments.

Signature of Authorized Signatory

Name :

Designation :

Name of Firm :

Address :

**Form Fin – 2 A: BOQ-1(Online specimen- To be filled in
online is excel sheet under financial cover)**

Validate

Print

Help

Item Rate BoQ

Name of the Bidder/ Bidding Firm / Company:					
NUMBER #	TEXT #	NUMBER #	TEXT #	NUMBER #	TEXT #
Sl. No.	Item Description	Quantity	Units	AMOUNT Rs. P	TOTAL AMOUNT In Words
1	2	3	4	6	7
1.1	Design, construction, supply installation, testing and commissioning of 10 nos. Concrete Jetties in New National Waterways in J&K	10	Per Set		
1.2	CAMC of 10 nos jetties for 10 years	10	Per set		
Total in Figures					
Quoted Rate in Words					

SECTION-VI: TERMS OF REFERENCE (ToR)

PART I – DETAILED SCOPE OF WORK

1. Background and brief about Project

- 1.1. Inland Waterways Authority of India (IWAI) [hereinafter referred to as "employer"] is a statutory body under the Ministry of Ports, Shipping & Waterways, Government of India. IWAI was set up in 1986 for regulation and development of Inland Waterways for the purposes of shipping and navigation. IWAI is primarily responsible for development, maintenance and regulation of Inland Water Transport (IWT) in the country and specifically National Waterways (NW). In April, 2016, the Government of India has declared 106 new National Waterways in addition to the existing five National Waterways.
- 1.2. Inland Waterways Authority of India primarily undertook the work of development activities in 5 National waterways i.e National Waterway No-1 (Allahabad-Haldia Stretch of the Ganga Bhagirathi- Hooghly River) Act, 1982, National Waterway No-2 (Sadiya-Dhubri Stretch of Brahmaputra River) Act, 1988, National Waterway No 3 (Kollam-Kottapuram Stretch of West Coast Canal and Champakara and Udyogmandal Canals) Act, 1992 , National Waterway No-4 (Talcher-Dhamra Stretch of Rivers, Geonkhali- Charbatia Stretch of East Coast Canal, Charbatia-Dhamra Stretch of Matai River and Mahanadi Delta Rivers) Act, 2008 and National Waterway No-5 (Kakinada-Puducherry Stretch of Canals and the Kaluvelly Tank, Bhadrachalam-Rajahmundry Stretch of River Godavari and Wazirabad- Vijayawada Stretch of River Krishna) Act, 2008 under the ambit of IWAI Act 1985.
- 1.3. Inland Water Transport (IWT) has the potential to form the most economic, reliable, safe and environmentally friendly form of transport. When developed for use by modern inland waterway vessels, it can reduce investment needs in rail and road infrastructure, promote greater complementarities in the riparian states, enhance intra-regional trade and, through increased economies of scale, significantly reduce overall logistics costs for the benefit of the entire economy and India's global trade competitiveness.
- 1.4. Among the various interventions being undertaken by IWAI is construction of multi modal terminal, setting up of floating terminals at various locations, setting up of RIS services, provision of Ro-Ro services dredging across the across the aforementioned national waterways.
- 1.5. The Parliament of India in the year 2016 enacted the National Waterways Act 2016 vide which additional 106 National Waterways were declared. Total 3 nos National

Waterways either pass through or are in the UT of Jammu & Kashmir i.e. Chenab River (NW-26), Jhelum River (NW-49) & Ravi River (NW-84).

- 1.6. After declaration of National Waterways, IWAI prepared the FSR in the first instance and the waterways that were found feasible, DPR's were prepared for these National Waterways. The FSR and DPR can be accessed through the links <http://iwai.nic.in/fsr-report> and <http://iwai.nic.in/waterways/dpr-report> respectively.
- 1.7. Chenab River (NW-26) has been declared as NW-26 from Chenab Road Bridge (Reasi) to bridge near Bhardakalan Village (near Jammu). The NW is situated near the sensitive Indo-Pak Border. A river cruise is proposed from Reasi to Akhnoor Fort. The Akhnoor Fort in Jammu is a major tourist spot and is intended to be connected through 2 jetties for cruise tourism at Akhnoor & Reasi.
- 1.8. River Jhelum (NW-49) has been declared as NW from Sangam (Anantnag) to Wular Lake. The DPR has been prepared by WAPCOS and it is proposed to be developed from River Cruise tourism point of view.
- 1.9. River Ravi (NW-84) has been declared as NW-84 from Ranjit Sagar Dam to Chamera Dam at Gandhian. The NW passes through the UT of J&K and states of Himachal Pradesh and Punjab. The total declared length is 44.276 Kms. This NW has been considered for River Cruise Tourism. The proposed cruise length is 14.4 Km. The dam area is a major tourist spot.

2. Scope of Work

- 2.1. The proposed jetties will be floating concrete jetties as described in Part-2- Technical specifications. The design and drawing of the proposed jetties will be vetted by NTCPC before the jetties go into production stage. Further, during the production stage, the construction will be carried out under the supervision of IR Class.
- 2.2. The floating jetties size at various location (Table Part-II A) (either single set or modular) shall be moored by anchor / sinker chain or spud type arrangement with piling duly catered with a marine grade aluminium Warren truss type gangway connected to the quay or bank seat by means of a properly designed pivot arrangement. All these are deemed to be included in the price quoted by bidder.
- 2.3. The layout should allow for a recommended future extension higher size. This augmented size will provide three times the berthing capacity (three crafts on the outside and one on the inside).

2.4. The details are provided in Technical specifications. The jetty is primarily to be used for safe berthing of passenger vessels/ small cargo vessels upto 1000 DWT facilities. The same usage of the terminal is envisaged in the future as well. The floating jetty shall have appropriate arrangement to cater to the mooring requirements of the vessels. The floating jetty shall be designed for sufficient load capacity and stability to serve its intended purpose. The appearance of the jetty shall be aesthetically good and shall have superior finish.

2.2 Preliminary Works

- (a) The Contractor shall review the available data and reports pertaining to the Works and shall
 - (i) Carry out all the survey, design and approval of drawings and detailed design of pontoons and gangways as detailed in Technical specifications.
 - (b) The Contractor shall also make a detailed analysis of the site and existing facilities available for developing the floating jetties.
 - (c) The Contractor based upon the surveys and detailed analysis shall submit periodically Work plan / methodology for carrying out the execution of Work to the Engineer in Charge (EIC) or his representative for this approval. The contractor shall bear all the cost arising out of surveys and detailed analysis.
 - (d) The Work plan to be submitted by the Contractor shall include
 - i. The Works Program.
 - ii. Health & Safety Plan.

3. Timelines

- (a) The Contract duration shall be 5 (Five) months from the date of signing the agreement to this effect.
- (b) The Contractor shall submit a detailed work plan indicating the timelines for main and miscellaneous activities to the EIC for approval.
- (c) The Contractor, in the course of the work, after deliberations with the EIC, shall agree and incorporate the necessary changes within timelines. The Contractor shall get the macro and micro level activity plan and methodology statement(s) approved by the EIC.

- (d) The Contractor shall abide with the timelines in the Work Plan.
- (e) No idle time charges on any account shall be paid to the contractor during the contract period.

4. Milestones

- 4.1 The Contractor shall carry out work within a period of 5 months till satisfaction of engineer in charge and handing over the completed facility IWAI.
- 4.2 The contractor, within 15 days from the Letter of award, should submit detailed Schedule of activities including procurement and fabrication schedule, supply and testing schedule, installation and commissioning schedule, method statements, QC Manual including all data and reporting formats, for comment from EIC and should include all comments and observations to get the same approved by EIC.
- 4.3 The Contractor shall during the execution of works adhere to the Project Milestone set forth for the works on monthly basis so as to ensure the completion of Works within the stipulated duration.

Activity	Time (in months from the date signing of agreement)
Submission of preliminary design and methodology for all the activities for comments from EIC	T+ 30 days
Completion of Fabrication of concrete Pontoons	T + 110 days
Installation of pontoon along with all accessories, gangways * (successful launching)	T+ 140 days
Testing, commissioning handing over of concrete pontoons for providing floating terminal facilities and gangway.	T+ 150 days
Defect liability period	12 months after final delivery and taking over

- 4.4 It may be noted that the milestones defined above are for the complete scope of the work. The Contractor shall ensure to adopt all necessary means during execution of works to achieve all the milestones. Failure of achieving milestones would attract LD as defined in Clause 8.12 of GCC.

5. Deliverables and Payment Schedule

-
- 5.1 The Contractor shall submit stage wise Bills for performing the works, from the Date of Commencement of Work, which will be verified by the Engineer-in-charge subject to deductions as applicable, and recovery towards repayment of Mobilization Advance & other recoveries, if any.
- 5.2 The total Contract Price payable under the Contract shall be stipulated in the Letter of Award and thereupon shall become part of this Contract and be paid in accordance with the terms ref. 5.5 hereon. The price quoted will squarely and totally include all the charges to be paid to the contractor by the Employer
- 5.3 Total Contract Price shall be firm and fixed and shall not be subject to any escalation during the period of the Contract except for any adjustment in accordance with the terms of the Contract.
- 5.4 The Contractor shall submit Running Account Bills (RA Bills) on or before the milestone dates fixed by Engineer-In-Charge (EIC) for the quantity and/or work executed with respect to the work progress requirements. The Contractor shall be paid as per the RA Bills submitted for the work done within one month from submission of correct claim of bill. The contractor will submit the RA Bill in triplicate accompanied with 3 sets of supporting documents. Subject to deduction and other changes authorized by and to the other provisions of this contract, employer shall pay to the contractor for the tendered work at specified destination, for the floating pontoons/jetties and for all other works, matters, things and obligations to the executed, done, supplied and performed by the contractor under this contract with respect to the contract price. Unless otherwise agreed in writing between Chairperson on behalf of Authority and the Contractor payment for the works shall be made by Chairperson on behalf of Authority, by electronic system i.e. RTGS in instalments upon production of the certificate of the inspector appointed by owner for the inspection of the construction of the vessel(s) against the instalment due subject to the condition that the amount of an instalment payment shall in no case exceed the value of the work done as per following stages.

5.5 Stages of Payment

S.No	%age	of	Description of completion status
------	------	----	----------------------------------

	Contract value	
1.	10%	After approval of design of concrete pontoons by NTCPWC
2.	60%	Completion of 100 % fabrication of pontoons (payment on pro-rata basis) with due certification of IR Class
3.	20%	Supply Installation commissioning of Pontoons at the earmarked site.
4.	10%	On IR Class certification of the commissioned pontoons
5.	1/20 of the total CAMC period	To be paid half-yearly.

6. Manpower

The Contractor shall deploy the requisite manpower as is suitable duly indicating the position in Form-4E.

- (a) The Contractor shall however undertake that all the time required number of personnel necessary for efficient execution of contract and as required by applicable law
- (b) The Contractor shall engage persons with necessary qualification / experience during the entire period of the Contract.
- (c) The list of all the personnel engaged in the Contract will be given to EIC before commencement of work. Personnel will be changed only after approval of EIC.

7. Annual Maintenance Contract

The Maintenance to be provided after defect liability period for a period of 10 years (ten years) for & maintenance of all the FLOATING JETTIES provided including replacement/repairs/ painting etc. for safety and serviceability of floating pontoons

Note: 1.All consumables in AMC will be reimbursed as per actual by IWAI.

2. All payments AMC will be paid in ten equal instalments at the end of each year.

MAINTENANCE OF JETTIES

Broad items to be considered in AMC period are as under.

a) **Monthly**

- Concrete deck should be regularly washed down to maintain a clean appearance
- The fenders should be checked for damage.
- The navigation lights should be checked
- The gangway should be checked.

b) **Yearly**

- The connecting bolts and rubber should be checked.
- The mooring chains (in case mooring is considered) should be adjusted by a few centimetres so that any wear at the bell mouth and stopping off point is distributed.
- Every 1 years the chains should be inspected by an engineer / diver.

On commencement of AMC period and before the return of Security deposit by IWAI, the vendor shall deposit a Bank Guarantee @ 5% of contract price on yearly basis to IWAI. The B.G. shall be validated each successive year

8. Organization

The selected Contractor shall depute well-qualified officers/team having sufficient experience in execution of similar works as indicated in this Tender Document. If the progress of work is found unsatisfactory during the currency of the contract, Contractor/Bidder shall promptly mobilize additional personnel/resources for ensuring satisfactory progress and timely completion of the proposed work, as per direction of and satisfaction of Engineer-In-Charge under the contract without extra cost to IWAI.

9. Duties & Responsibilities of the Contractor

- 9.1 The primary responsibility of the Contractor is to undertake the work as detailed below in [Part-II- Technical Specifications](#) for Design, construction, supply installation, testing and commissioning of 8 nos. Concrete Jetties in New National Waterways as per terms and conditions of this tender and directions of EIC during the entire period of the contract.

9.2 Correction of Defects

If any defects including workmanship of structure, machineries or any other part of

the structure appear within twelve (12) Months of taking over certificate, the owner shall give notice to the contractor of any defect before the end of the defects liability period which begins at completion, and is for Twelve (12) Months thereafter. The defects liability shall be extended for as long as defects remain to be corrected.

When the notice regarding the defect is given, the contractor shall correct the notified defect at his own cost within the a period of 15 days specified by the owner in notice issued by him. If the contractor is in default, the owner shall cause the same to be made good by other workmen and deduct the expense from any sum that may be due to the contractor.

If the contractor has not corrected a defect, to the satisfaction of the engineer-in-charge, within the time specified in the notice, the owner will assess the cost of having the defect corrected and the contractor will pay this amount.

10. Supervision and Monitoring

Monitoring shall be undertaken by the employer, this shall be done by IWAI representative or an appointed supervision consultant or EIC (engineer in charge). Any supervision and monitoring shall not relieve the contractor from his contractual obligations, including his duty of quality control, survey and all such factors.

11. Association of Part I and Part II of ToR

The technical specifications detailed in part II of ToR shall be read in conjunction with part I – scope of work. Additional works detailed in part II of ToR shall also fall in the scope of work of the contractor.

PART II – TECHNICAL SPECIFICATIONS

A. PONTOONS

1. General

1.1 Inland Water Transport (IWT) has the potential to form the most economic, reliable, safe and environmentally friendly form of transport. When developed for use by modern inland waterway vessels, it can reduce investment needs in rail and road infrastructure, promote greater complementarities in the riparian states, enhance intra-regional trade and, through increased economies of scale, significantly reduce overall logistics costs for the benefit of the entire economy and India's global trade competitiveness.

Table Part-II-A

Sl. No.	Name of State	NW's	Location of Concrete Jetty	Size
1	Jammu & Kashmir	Chenab River (NW-26)	1 Jetty at Aknoor	30m*6m
2			1 Jetty at Reasi	24m*6m
3		Jhelum River (NW-49)	1 Jetty at Panth Chowk	30m*6m
4			1 Jetty at Zero Bridge	30m*6m
5			1 Jetty at Amira Kadal	30m*6m
6			1 Jetty at Shah-e-Hamdan	30m*6m
7			1 Jetty at Safa Kadal/Chattabal Shrine	30m*6m
8			1 Jetty at Sumbal Bridge	30m*6m
9			1 Jetty at Gund Prang	30m*6m
10		Ravi River (NW-84)	1 Jetty at Ranjit Sagar Dam U/S	30m*6m

- 1.2 The design and drawing of the proposed jetties will be vetted by NTCPWC before the jetties go into production stage. Further, during the production stage, the construction will be carried out under the supervision of IR Class.
- 1.3 The layout should allow for recommended future extension to augment size to 48 m x 12 m (will provide three times the berthing capacity (three crafts on the outside and one on the inside)).

2 LOCATION DETAILS-

2.1 Chenab River (NW-26)

River Chenab has been declared as NW-26 from Chenab Road Bridge(Reasi) to bridge near Bhardakalan Village (near Jammu). The NW is situated near the sensitive Indo-Pak Border. A river cruise is proposed from Reasi to Akhnoor Fort. The Akhnoor Fort in Jammu is a major tourist spot and is intended to be connected through 2 jetties for cruise tourism at Akhnoor & Reasi.

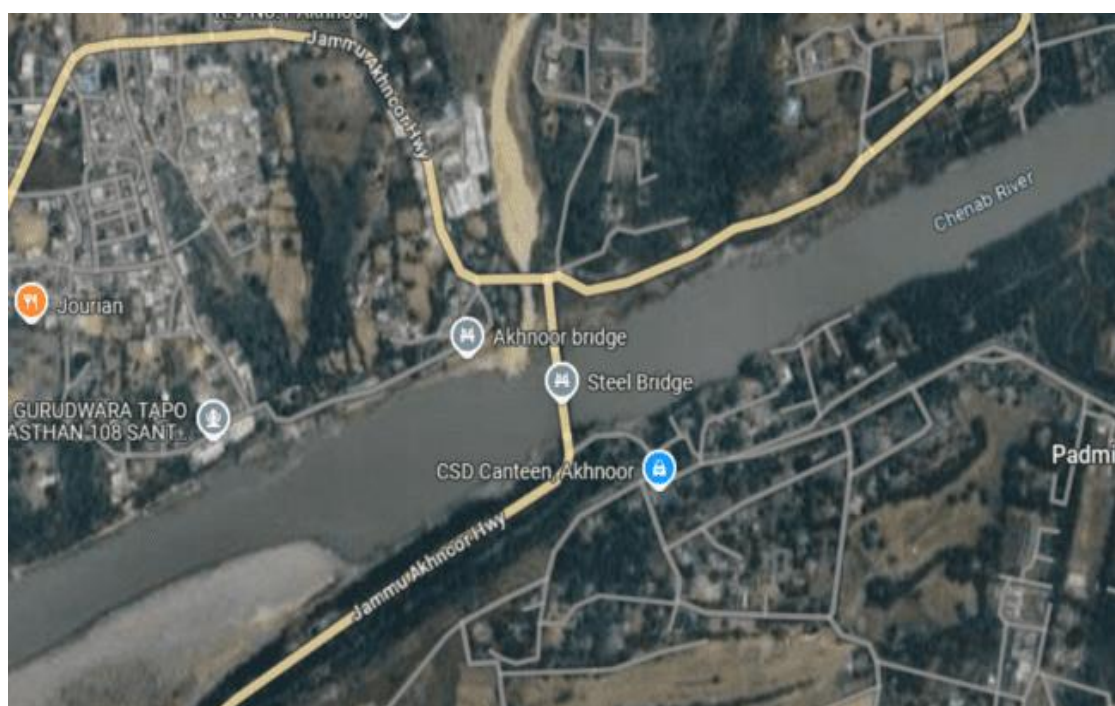

Fig 1. – floating Concrete jetty at Akhnoor Bridge



Fig 2. – floating Concrete jetty at Reasi

2.2 River Jhelum (NW-49)

River Jhelum has been declared as NW from Sangam (Anantnag) to Wular Lake. The DPR has been prepared by WAPCOS and it is proposed to be developed from River Cruise tourism point of view.



Fig 3. floating concrete jetty at Pantha Chowk



Fig 4. floating concrete jetty at Zero Bridge



Fig 5. floating concrete jetty at Amira Kadal



Fig 6. floating concrete jetty at Shah-e-Hamdan



Fig 7. floating concrete jetty at Safa Kadal



Fig 8. floating concrete jetty at Sumbal Bridge

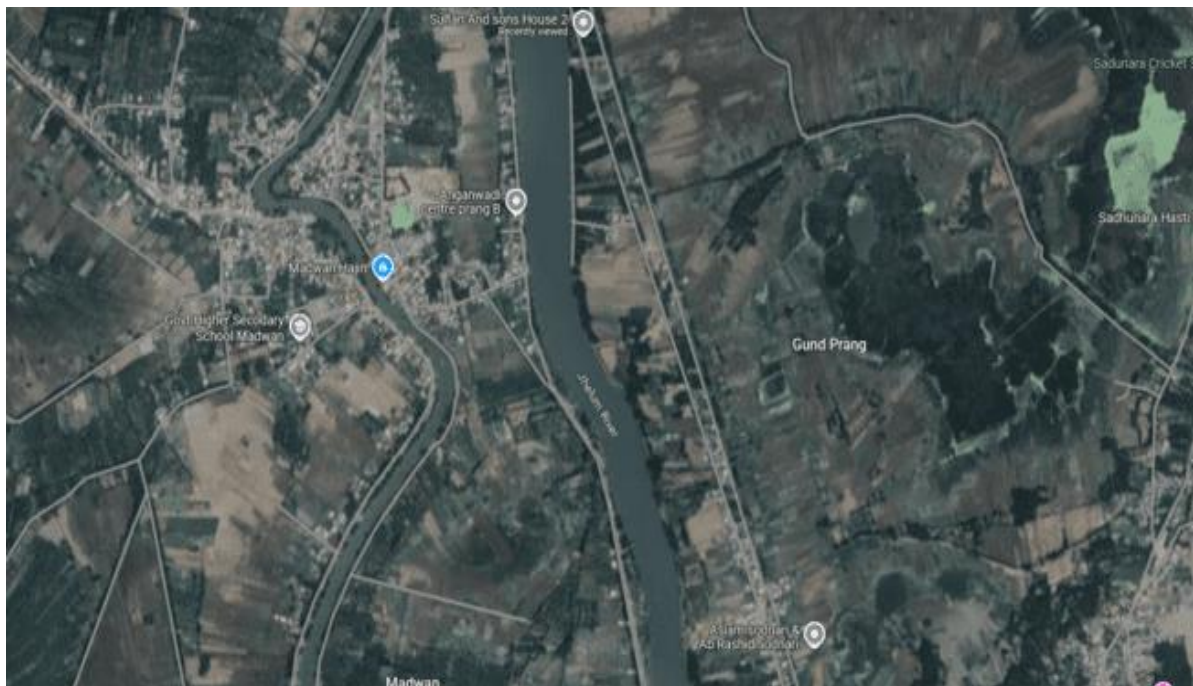

Fig 9. floating concrete jetty at Gund Prang

2.3 River Ravi (NW-84)

River Jhelum has been declared as NW-84 from Ranjit Sagar Dam to Chamera Dam at Gandhian. The NW passes through the UT of J&K and states of Himachal Pradesh and Punjab. The total declared length is 44.276 Kms. This NW has been considered for River Cruise Tourism. The proposed cruise length is 14.4 Km. The dam area is a major tourist spot.

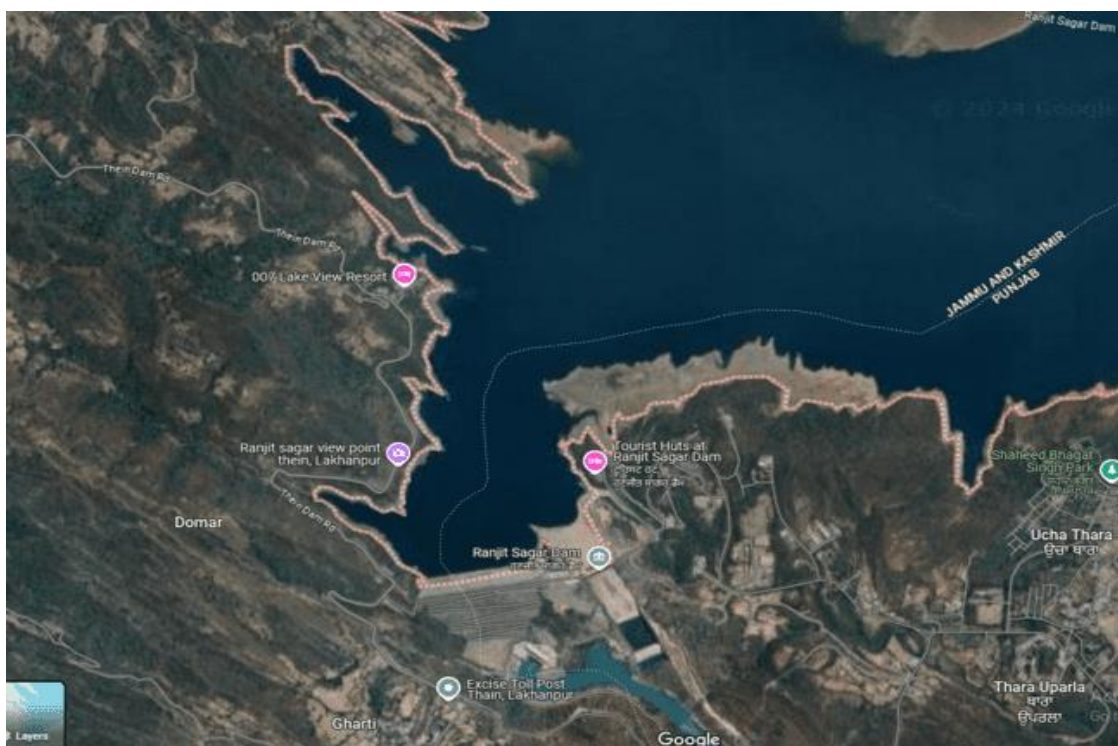

Fig 10. floating concrete jetty at Ranjit Sagar Dam

3 Functional Requirements

The works under this contract broadly includes following:

Pontoons shall be suitable for operations in inland waters, the design and drawing of pontoons will be sent for approval of NTCPWC, IIT Madras and the production will start after approval of NTCPWC.

During the process of construction, the construction will be supervised by IR Class and they will certify the successful completion of work.

3.1 JETTY INSTALLATION

SITE IMPERITIVES

- Physical access to the site
- Vehicle parking
- Boat berthing and backup systems
- Availability of water & electrical services
- Safe anchorage
- Tourist handling facilities

FACILITIES PLANNED

- Navigation aids
- Alongside protection
- Bilge water evacuation (at managed locations)
- Solar lighting
- Security
- Fire safety
- Life saving and first aid

3.2 LAYOUT

The floating jetties shall be having dimension of as per PART-II Technical Specification Clause 1.1 moored by anchor / sinker chain and accessed by a marine grade aluminium Warren truss type gangway (of appropriate length as per existing site conditions) connected to the quay or bank seat by means of a properly designed pivot arrangement.

The layout should allow for a future extensions.

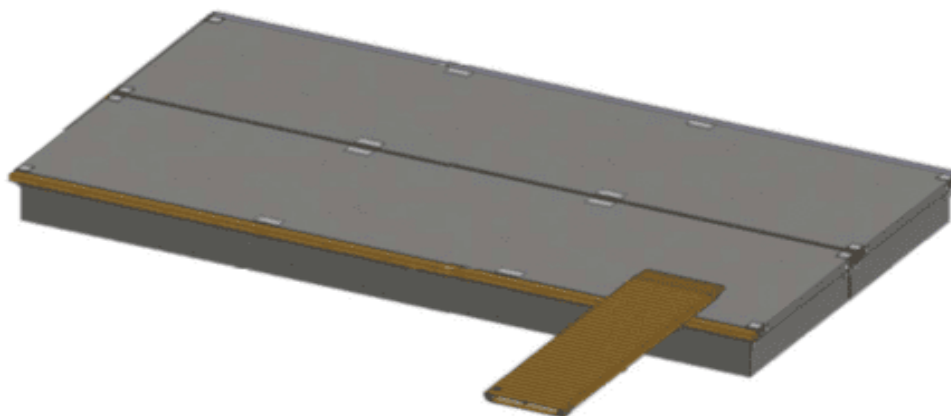

Fig: 11 A 3-dimensional view of floating jetty arrangement with access gangway

3.3 MOORING SYSTEM

The floating concrete jetties shall be secured with chain moorings, as this system is more suitable for the intended use as compared with mooring piles. Chain moorings are better than piles in that they allow the pontoon to ride out larger waves because the chain catenary acts as a shock absorber making the whole system more resilient and flexible, whereas a pile system is not. The other big advantage of chain moorings is that unlike mooring piles, there is no intrusion or construction on the riverbed and the position of the floating jetty can be easily adjusted at anytime.

The mooring system for the project should be properly designed and incorporate steel anchors and / or concrete gravity sinkers of appropriate size, weight and design to achieve the best anchoring result in the seabed at the installation site. It should be strong enough to allow up to four tourist boats banked alongside each other at each berth.

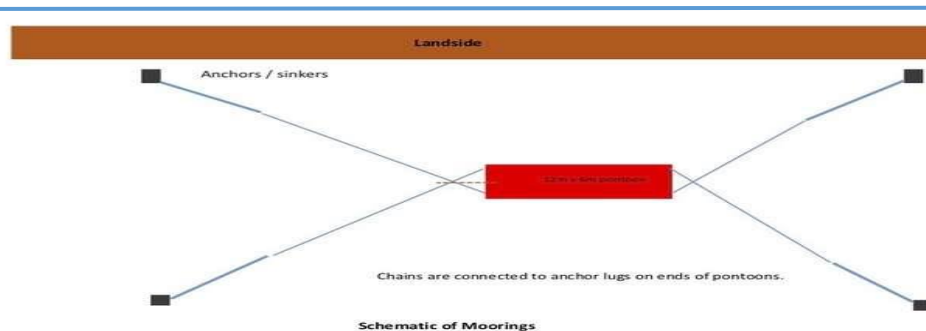

Fig 12 Mooring spread floating concrete jetty

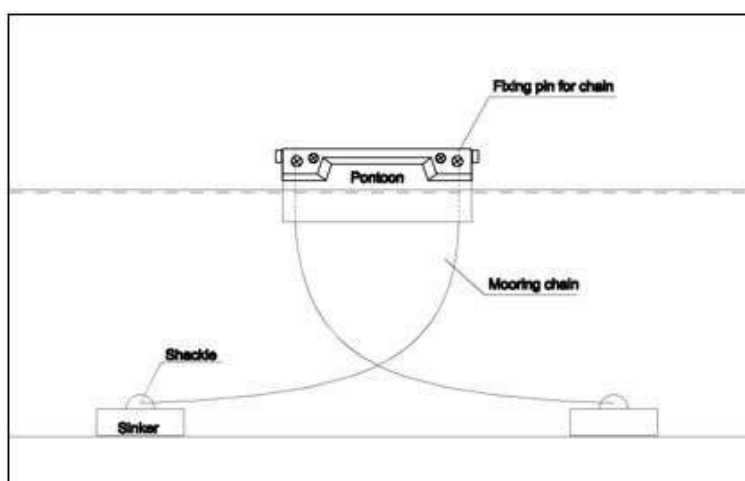

Fig 12. Typical chain mooring arrangement

Further instead of mooring, spud arrangement may be used with Piles (Steel and Concrete piles). In case the bidder intends to use spud, the design and drawings may be submitted along with the bid.

INSTALLATION CONCERNS

- Dead load shall be considered including weight of pontoon, cleats, fenders, pile guards, water facilities, fire extinguishing systems, electrical cabling, lights, fuel dispensers, drainage outlet and pumps, if any.
- The slope of the walkway shall be true and level.
- Horizontal loading conditions should take into consideration the impact of the vessel movement considering speed of 0.5m/sec. and at an inclination of 10 degrees to the docks.
- Current load shall be allowed for based on V max for the site.
- Wind load shall be calculated using "Tobias son" and the V max for the site.
- Bollard strength should be adequate to bear the load of tourist crafts double-banked alongside each other at each berth.
- Gangways shall be designed for a live loading of 3kPa.
- Hydrographic Survey at the site is within the scope of Contractor.

3.4 BATHYMETRY

-
- Fresh bathymetry survey of each site should be carried out immediately by the contractor prior to the installation of floating jetty there.

The Contractor whilst applying for this tender is deemed to be aware of the following

- Bathymetric conditions. The bathymetric survey will be carried out by the contractor. The price is deemed to be included in the price quoted.
- Soil investigation (as required for bank preparation work)- The soil investigation will be carried out by the contractor. The price is deemed to be included in the price quoted
- Marine traffic conditions
- Availability of services - water, solid waste disposal & electrical
- Wind and wave data
- Navigational channels near the proposed locations.
- Sediment build up near the place of installation
- Hydraulic circulation and natural flushing
- Flooding, tidal waves and storm data

3.5 OPERATION & MAINTENANCE

The recommended inspection / maintenance routine for floating concrete pontoon jetties would be –

- Weekly tasks –
 - Concrete deck should be regularly washed down to maintain a clean appearance as appropriate for a touristic facility.
 - Fenders (if fitted) should be checked for damage.
 - Functioning of the navigation light should be verified.
 - Gangway fixing and alignment should be checked.
 - Mooring chain assemblies should be checked.
- Yearly tasks –
 - The connecting bolts, rods and rubbers should be checked.
 - The mooring chains should be adjusted so that any wear at the bell mouth and stopping off point is distributed.
 - An engineer diver should inspect the moorings every third year.

3.6 CONCRETE PONTOON DESIGN

3.6.1 DESIGN STATEMENT

- Be designed for a service life up to 50 years and comply with relevant British and European standards.
- Be of monolithic construction meaning that there are no parts that can become loose or can be stolen.
- Be connected to the adjoining pontoons by massively strong bolts at each end. The connection to incorporate rubbers that allow for the flexing in wave conditions.
- Have a core of closed cell, expanded polystyrene foam that would makes the pontoon unsinkable.
- Be capable of being fitted with utilities such as electricity, water, and lighting, as well

as with fuel pipelines and black / grey water pipelines. All pipes and cables can be run safely below deck to avoid damages

3.6.2 DESIGN CONSIDERATIONS

- Functional berthing (this means that the pontoons must provide safe and convenient berthing for the vessel).
- Resistance to environmental conditions, the main ones being –
 - Wave forces
 - Wind loadings
 - Current
 - Live loading on the deck
 - Vessel impact
 - Temperature
 - High humidity
- Water absorption of 3% or less in the EPS (expanded polystyrene) flotation, and protection of the EPS from attack by marine flora and fauna.
- Minimum surface cracking of the concrete.
- Zero corrosion of the steel reinforcement.
- 20 year fatigue life of the pontoon-to-pontoon connections.
- Resistance to fire adequate to allow evacuation.
- Anti slip deck surface for safety of personnel.
- Use of corrosion free material where required.
- Basic standards of the concrete pontoons -
 - Fully reinforced concrete structure with hot dipped galvanized reinforcement or CRS reinforcement.
 - Bottom protection.
 - Pontoon to pontoon connection to be simple, requiring minimal maintenance.
 - Concrete admixtures to minimize cracking.
 - Through hull mooring tubes, if required, that permits anchoring by chain mooring.
 - High-capacity bollards that directly transmits the mooring forces through the main load bearing structure to the mooring system.
 - Standard concrete mix M45 or greater.

3.6.3 CONSTRUCTION SPECIFICATIONS

- Net deck loading capacity shall be in excess of 5kN/m².
- The pontoons shall be monolithic and have sufficient strength to handle up to 7.0 m everyday wave height(in case of tidal region) and 9 m variation during flood seasons.
- The pontoon should meet ISO 9001 and ISO 14001 standards of classification societies such as IR Class, Det Norske Veritas, Lloyds etc. The reinforced concrete design should meet EU standards for maritime structures. Reinforcement to be corrosion resistant steel and polypropylene fibres; the latter shall be mixed into the concrete to minimize cracking.
- The underside of the expanded polystyrene shall have a flexible polyurea or similar coating applied before casting of the concrete. The polyurea should protect the polystyrene from attack of marine flora and fauna.
- Suitable diameter(100mm or more) ducts shall be cast-in beneath the deck to run utilities as may be required, safely out of the site.
- All bolts, fasteners, bollards and other fitment items shall be hot dipped galvanised (with minimum 150 micron galvanising thickness) or stainless steel of 316L grade.

- The berthing face of the floating jetty shall be protected from damage by stainless steel sheet of adequate thickness. No fixed rubber fenders.

3.6.4 TECHNICAL DATA

Each pontoon (single/modular) meeting the following requirements –

- **Length & Width:** as described above for 2 locations.
- **Unladen Freeboard:** 0.5m, allowing for 10% variance.
- **Connection strength:** adequate for the environmental conditions
- **Concrete strength:** minimum 45 N/mm².
- **Exposure class:** according to European EN 206-1 standards.
- **Core:** expanded polystyrene, minimum density 15 kg/m³.
- **Connections:** minimum 300 kN capacity strength
- **Reinforcement:** fully hot dip galvanized steel or corrosion resistant steel.
- **Accessories:** bollards, SS sheet berthing protection, water and cable ducts.

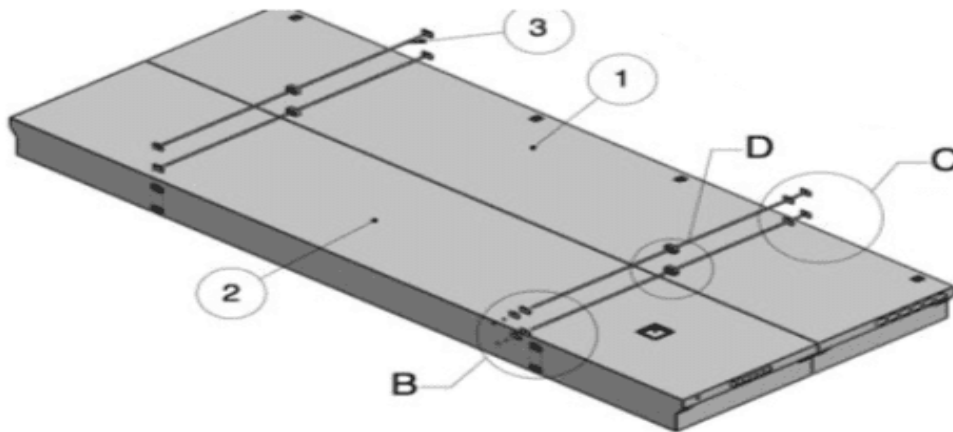

Fig 13. Side-by-side fixing arrangement

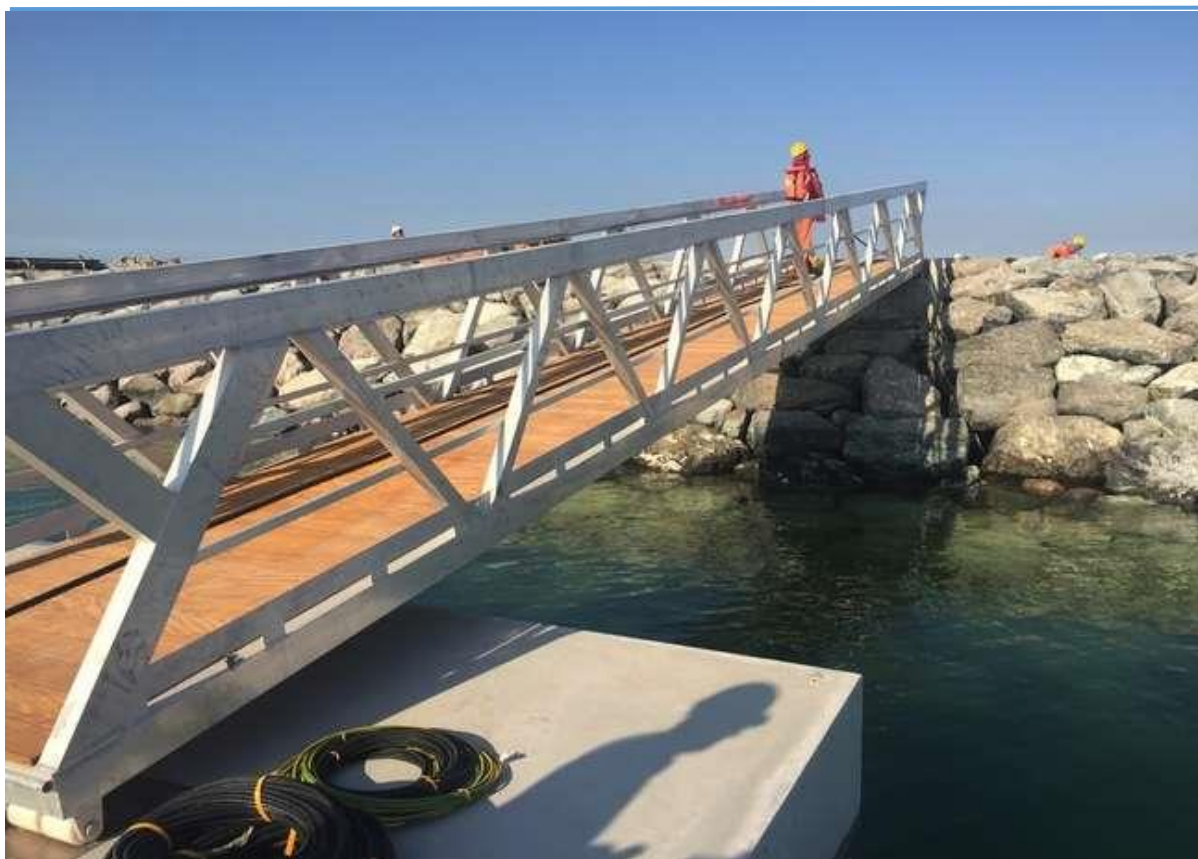

Fig 14. Aluminium access gangway

3.7 SCHEDULE OF TECHNICAL REQUIREMENTS (SOTR)

3.7.1 FLOATING JETTY SYSTEM FOR VESSELS

To achieve the best combination of utilization, durability, seaworthiness, safety and low maintenance, plus the ability to be moved or re-located (if ever required), the floating jetty shall meet the following specifications.

Sno	Specification	Rationale
1.	The pontoons shall be constructed of reinforced concrete.	To ensure stability and seaworthiness, zero corrosion / low maintenance and safety.
2.	The concrete shall be reinforced with hot dipped galvanized steel and / or corrosion resistant steel (CRS).	To ensure that the reinforcement does not corrode and cause failure of the concrete.
3.	The deck of the jetty shall be plain concrete with anti-slip finish	To ensure safety even during wet conditions
4.	A minimum of 4 under deck utility ducts shall be provided for each of the pontoons.	To accommodate any water, electricity or fuel service (if required).

5.	All connecting parts and all cast-in components shall be of stainless steel	For strength and corrosion prevention
6.	5t mooring bollards, directly connected to the main structure of the jetty and suitable for ropes up to 30mm diameter (one roll) shall be provided at no more than 4m spacing along both sides of the jetty. These shall be hot-dipped galvanized steel, cast aluminium alloy, or stainless steel.	For mooring boats
7.	Stainless steel sheet protection of adequate thickness shall be provided along both sides of the jetty, suitable for all types of local tourist/cruise vessels to be berthed alongside.	To prevent damage to the jetty.
8.	A double fixed solar powered LED navigation light shall be fixed in a 2.5m high pole at the outer end of the jetty.	For navigation safety at night
9.	The jetty shall be accessed by a Warren truss type gangway of Suitable length (to be assessed by the contractor) and internal width 0.9m, constructed of marine grade aluminium and fitted with anti-slip decking and having nylon rollers resting on stainless steel running plates on the deck of the jetty. The gangway should be held at the shore end by a stainless steel pivoting arrangement.	To ensure low weight and safe access.
10.	The jetty shall be held in position using minimum Grade 30 chains of strength and steel anchor / concrete sinkers. The mooring lines shall not impede the movement of the boats. The 2 nos. concrete round bollard 0.5m dia. to be casted (2m depth and 1m height from the ground level) on the shore / river bank for safe mooring of the jetty with ropes or, wire ropes.	To ensure safe positioning of the jetty against all normal environmental and operational forces.

11.	The jetty shall be designed to withstand, everyday wave height of 0.4m from any direction and an occasional (i.e. storm) wave height of 0.6m from any direction.	To ensure durability and survivability
12.	The jetty shall have a demonstrable design life under normal operating conditions of at least 25 years with minimum maintenance.	To ensure durability and value for money
13.	The jetty shall have an unloaded freeboard 0.5m, allowing a 10% variation.	To provide the greatest range of mooring possibilities for boats.
14.	The length and width dimensions specified for each jetty are normal ones and the supplier may offer his proprietary products having slightly different dimensions	To allow proprietary product to be used
15.	The jetty system shall hold accreditations from national and / or internationally recognised classification authorities	To demonstrate that the jetty system meets recognized quality and safety standards
16.	The railing should be stainless steel 1m height around the jetty.	To ensure safety of passenger.
17.	Suitable no. of tyre fenders to be properly tied with jetty.	To ensure safety of jetty.
18.	Hydrographic survey	To be conducted half a Km U/S & D/S of proposed jetty location at 25m interval
19.	Soil testing	2 bore holes at near proposed jetty location

SECTION - VII: GENERAL CONDITIONS OF CONTRACT

1. GENERAL PROVISIONS

1.1 Definitions

- 1.1.1 **Employer** **Employer** means the Chairman, Inland Waterways Authority of India and his successors.
- 1.1.2 **Authority/ Department/ Owner** **"Authority/ Department/ Owner"** shall mean the Inland Waterways Authority of India, which invites tenders on behalf of the Chairman, IWAI and includes therein-legal representatives, successors and assigns.
- 1.1.3 **Chairman** **Chairman** means Chairman of Inland Waterways Authority of India.
- 1.1.4 **Chief Engineer** **Chief Engineer** means the Chief Engineer of the Authority.
- 1.1.5 **Director** **Director** means the Director of the Authority, as the case may be.
- 1.1.6 **Deputy Director** **Deputy Director** means the Deputy Director of the Authority, as the case may be.
- 1.1.7 **Contractor** **Contractor** means the successful Bidder who is awarded the contract to perform the work covered under this tender document and shall be deemed to include the Contractor's successors, executors, representatives approved by the Engineer-in-charge.
- 1.1.8 **Contractor's Representative** **"Contractor's Representative"** means the person named by the Contractor in the Contract or appointed from time to time by the Contractor, who acts on behalf of the Contractor.
- 1.1.9 **Employer's Personnel** **"Employer's Personnel"** means the Engineer, the assistants and all other staff, labour and other employees of the Engineer and of the Employer; and any other personnel notified to the Contractor, by the Employer or the Engineer, as Employer's Personnel.
- 1.1.10 **Contractor's Personnel** **"Contractor's Personnel"** means the Contractor's Representative and all personnel whom the Contractor utilises on Site, who may include the staff, labour and other employees of the Contractor and of each Subcontractor; and any other

-
- personnel assisting the Contractor in the execution of the works.
- 1.1.11 **Engineer-In-Charge/Engineer** **Engineer-In-Charge (EIC) or Engineer** means the Employers personnel authorized to direct, supervise and be in-charge of the works on behalf of the Employer.
- 1.1.12 **"Subcontractor"** **"Subcontractor"** means any person named in the Contract as a Subcontractor for a part of the Works or any person to whom a part of the Works has been subcontracted by the Contractor with the consent of the EIC and the legal successors in title to such person, but not any assignee of any such person.
- 1.1.13 **Engineer-in-charge representative/assistant** **Engineer-in-charge representative/assistant** shall mean any officer of the Authority nominated by the Engineer-in-charge for day to day supervision, checking, taking measurement, checking bills, ensuring quality control, inspecting works and other related works for completion of the project.
- 1.1.14 **"Contract"** **"Contract"** means the Contract Agreement, the Letter of Award, the Form of Tender, the Conditions (GCC & SCC), the ToR, the Specifications, the Drawings, and the further documents (if any) which are listed in the Contract Agreement or in the Letter of Award.
- 1.1.15 **"Specification"** **"Specification"** means the technical specifications and special conditions of the Works included in the Contract and any modification thereof or addition thereto made or submitted by the Contractor and approved by the Engineer.
- 1.1.16 **Party** **Party** means either the employer or the contractor as the case may be and "parties" means both of them.
- 1.1.17 **Commencement Date** **"Commencement Date"** means the date notified under clause 8.1 of GCC.
- 1.1.18 **Time for Completion** **"Time for Completion"** means the time for completing the execution of and passing the Tests on Completion of the Works or any Section or part thereof as stated in the Contract (or as extended under Clause 8.6 of GCC) calculated from the

Commencement Date.

- 1.1.19 **Day** "Day" means a calendar day and "Year" means 365 days.
- 1.1.20 **GCC** "GCC" means the General Conditions of Contract.
- 1.1.21 **SCC** "SCC" means the Special Conditions of Contract.
- 1.1.22 **Work Order** "Work Order" means a letter from the Authority conveying the acceptance of the tender/offer subject to such reservations as may have been stated therein.
- 1.1.23 **Letter of Award** "Letter of Award" means the formal letter issued by the employer to successful bidder to notify award of contract and shall specify including other terms and conditions, total contract price in consideration of execution & completion of works and the remedying of any defect therein by the contractor in accordance with the terms and conditions of the contract.
- 1.1.24 **Bill of Quantities** "Bill of Quantities" means the priced and completed bill of quantities forming part of the Tender.
- 1.1.25 **Tests on Completion** "Tests on Completion" means the tests specified in the Contract or otherwise agreed by the Engineer and the Contractor which are to be made by the Contractor before the Works or any Section or part thereof are taken over by the Employer.
- 1.1.26 **Interim Completion Certificate** "Interim Completion certificate" means a certificate issued on completion of work.
- 1.1.27 **Final Completion Certificate** "Final Completion Certificate" means a certificate issued after completion of work as per the SOW
- 1.1.28 **Contract Price** "Contract Price" means the price as specified in the letter of award subject to additions and adjustments thereto or deductions there from as may be made pursuant to the

-
- contract.
- 1.1.29 **Cost** "Cost" means all expenditure reasonably incurred (or to be incurred) by the Contractor, whether on or off the Site, including overhead and similar charges, but does not include profit.
- 1.1.30 **Accepted contract Amount** "Accepted contract Amount" means the amount accepted in the Letter of Award for the execution and completion of the Works including remedying of any defects.
- 1.1.31 **Final Payment Certificate** "Final Payment Certificate" means the payment certificate issued under Sub-Clause 14.10 of GCC.
- 1.1.32 **Goods** "Goods" means Contractor's Equipment, Materials, Plant and Temporary Works, or any of them as appropriate.
- 1.1.33 **Contractor's Equipment** "Contractor's Equipment" means all apparatus, machinery, vehicles and other things required for the execution and completion of the works and the remedying of any defects. However, Contractor's Equipment excludes Temporary Works, Employer's Equipment (if any), Plant, Materials and any other things intended to form or forming part of the Permanent Works.
- 1.1.34 **Site** "Site" means the places where the Permanent Works are to be executed and to which Plant and materials are to be delivered, and any other places as may be specified in the Contract as forming part of the Site.
- 1.1.35 **Permanent Works** "Permanent Works" means the permanent works to be executed by the Contractor under the Contract.
- 1.1.36 **Temporary Works** "Temporary Works" means all temporary works of every kind (other than contractor's Equipment) required on Site for the execution and completion of the Permanent Works and the remedying of any defects.
- 1.1.37 **Applicable Law** "Applicable Law" means the laws and any other instruments

having the force of law in India for the time being.

1.1.38 Approval

“**Approval**” means consent by the employer in writing

1.1.39 Drawings

“**Drawing**” means the drawings and plans specified in the specifications: The expression “**Work**” means all the works specified or set forth and required in and by the said specifications, drawing and schedule or to be implied there from or incidental thereto or to be hereafter specified or required in such explanatory instructions and drawings (being in conformity with the said original specifications, drawing and schedule) and also in such additional instructions and drawings not being in conformity as aforesaid as shall from time to time, during the progress of the work hereby contracted for, be supplied by the owner.

1.2 Interpretations

1.2.1 Where the contract so requires, words imparting the singular only shall also include the plural and vice versa. Any reference to masculine gender shall whenever required include feminine gender and vice versa.

1.2.2 Heading and marginal notes in these General Conditions shall not be deemed to form part thereof or be taken into consideration in the interpretation of construction thereof of the contract.

1.2.3 Wherever in the Contract provision is made for the giving or issuing of any notice, consent, approval, certificate or determination by any person, unless otherwise specified such notice, consent, approval, certificate or determination shall be in writing and the words “notify”, “certify” or “determine” shall be construed accordingly. Any such consent, approval, certificate or determination shall not unreasonably be withheld or delayed.

1.3 Law and Language

The Contract shall be governed by Indian Law.

The language for communications shall be English as stated in SCC.

1.4 **Priority of Documents**

The documents forming the Contract are to be taken as mutually explanatory of one another. For the purposes of interpretation, the priority of the documents shall be in accordance with the following sequence:

- a) The contract agreement (if completed)
- b) Integrity Agreement
- c) Letter of Acceptance/ Notice to proceed with the work
- d) Conditions of contract
- e) Schedule of the price bid.
- f) Technical Bid No. with Date
- g) Addenda/Corrigenda
- h) Minutes of Pre-bid Meeting.
- i) Post bid correspondences and any other document listed in the contract data as forming part of the contract.

If any ambiguity or discrepancy is found in the documents, the EMPLOYER / ENGINEER shall be the sole authority to issue any necessary clarification or instruction in this regard.

1.5 **Contract Agreement**

In terms of ITB 6.9, Section II of the Tender Document pertaining to JV / Consortium, the registration under Companies Act 2013 is mandatory after award of work and before signing of Agreement. Hence, the formality of incorporation of company under Registrar of Companies (as per the mission of Letter of Intent for JV / Consortium) including submission of Performance Bank Guarantee, PAN, GST registration & any other required additional document in favour of the registered company shall be submitted to the Employer within 30 days from the date of issuance of Letter of Award.

~~For Joint Venture Bidder, the Parties shall enter into a Contract Agreement within 45 days after the issue of the Letter of Award & for single entity Bidder, the Party shall enter into a Contract Agreement within 28 days after the issue of the Letter of Award.~~

The Contract Agreement shall be in the format annexed to the bid. The costs of stamp duties and similar charges (if any) imposed by law in connection with entry into the Contract Agreement shall be borne by the Bidder.

1.6 Assignment/sub-contracting

The Contractor shall not assign the whole or any part of the work to any other Party/Firm/Individual without prior written consent of the Employer.

1.7 Employer's Use of Contractor's Documents

- a) The Specification and Drawings shall be in the custody and care of the Employer. Unless otherwise stated in the Contract, four copies of the Contract and of each subsequent Drawing shall be supplied to the Contractor, who may make or request further copies at the cost of the Contractor. Each of the Contractor's Documents shall be in the custody and care of the Contractor, unless and until taken over by the Employer. Unless otherwise stated in the Contract, the Contractor shall supply to the EMPLOYER/ENGINEER six copies of each of the Contractor's Documents.
- b) The Contractor shall keep, on the Site, a copy of the Contract, publications named in the Specification, the Contractor's Documents (if any), the Drawings and Variations and other communications given under the Contract. The Employer's Personnel shall have the right of access to all these documents at all reasonable times. If a Party becomes aware of an error or defect of a technical nature in a document, which was prepared for use in executing the Works, the Party shall promptly give notice to the other Party of such error or defect.
- c) As between the Parties, the Contractor shall retain the copyright and other intellectual property rights in the Contractor's Documents and other project documents made by/or on behalf of the Contractor. The Contractor shall be deemed (by signing the Contract) to give to the Employer a non-terminable transferable non-exclusive royalty-free Licence to copy, use and Communicate the Contractor's Documents, including making and using modifications of them for the same work or other works under IWAI.

This Licence shall:

-
- 1) Apply throughout the actual or intended working life (whichever is longer) of the relevant parts of the Works,
 - 2) Entitle any person in authorized possession of the relevant part of the Works to copy, use and communicate the Contractor's Documents for the purposes of completing, operating, maintaining, altering, adjusting, repairing and demolishing the Works,
 - 3) In the case of Contractor's Documents, which are in the form of computer programs and other software, permit their use on any computer on the Site and other places as envisaged by the Contract, including replacements of any computers supplied by the Contractor.

The Contractor's Documents and other documents made by (or on behalf of) the Contractor shall not, without the Contractor's consent, be used, copied or communicated to a third party by (or on behalf of) the Employer for purposes other than those permitted under this Sub-Clause.

1.8 Contractor's use of Employer's Documents

As between the Parties, the Employer shall retain the copyright and other intellectual property rights in the Specification, the Drawings and other documents made by (or on behalf of) the Employer. The Contractor may, at his cost, copy, use, and obtain communication of these documents for the purposes of the Contract. They shall not, without the Employer's consent, be copied, used or communicated to a third party by the Contractor, except as necessary for the purposes of the Contract.

1.9 Disclosure of Confidential Details

The Contractor shall disclose all such confidential and other information as EMPLOYER may reasonably require in order to verifying the Contractor's compliance With the Contract.

1.10 Compliance with Laws

The Contractor shall, in performing the Contract, comply with applicable Laws.

Unless otherwise:

- a) the Employer shall have obtained (or shall obtain) the planning, zoning or similar permission for the Permanent works, and any other permissions

described in the Specification as having been (or being) obtained by the Employer; and the Employer shall indemnify and hold the Contractor harmless against and from the consequences of any failure to do so; and

- b) the Contractor shall give all notices, pay all taxes, duties and fees, and obtain all permits, licences and approvals for his equipment and manpower as required by the Laws in relation to the execution and completion of the Works and the remedying of any defects; and the Contractor shall indemnify and hold the Employer harmless against and from the consequences of any failure to do so.

1.11 Joint and Several Liability

~~If the Contractor constitutes (under applicable Laws) a joint venture, consortium or other unincorporated grouping of two or more persons/ companies~~

- a) ~~each such persons/ companies shall be deemed to be jointly and severally liable to the Employer for the performance of the Contract;~~
- b) ~~each such persons/ companies shall notify the Employer of their leader who shall have authority to bind the Contractor and each of these persons/ companies shall provide a parent company guarantee as a part of bid submission.~~
- c) ~~The Contractor shall not alter its composition or legal status without the prior consent of the Employer.~~

1.12 Contract Details to be Confidential

The Contractor shall treat the details of the contract as private and confidential, except to the extent necessary to carry out obligations under it or to comply with applicable laws. The Contractor shall not publish, permit to be published or disclose any particulars of the works in any trade or technical paper or elsewhere without written approval of the Employer.

2. Employer

2.1 Employer's responsibility

The Employer shall ensure that the work carried out by the Contractor on the Site with:

-
- (a) full regard to the safety of all persons entitled to be upon the Site, and
 - (b) keep the Site in an orderly state appropriate to the avoidance of danger to such persons.

If under Clause 4.29 and 4.30 the Employer shall employ other contractors on the Site he shall require them to have the same regard for safety and avoidance of danger.

2.2 Employer's Risks

The Employer's risks are, in so far as they directly affect the execution of the Works in the country where the permanent works are to be executed:

- d) war, hostilities (whether war be declared or not), invasion, act of foreign enemies,
- e) rebellion, revolution, insurrection, or military or usurped power, or civil war,
- f) ionising radiations, or contamination by radio-activity from any nuclear fuel, or from any nuclear waste from the combustion of nuclear fuel, radio-active toxic explosive or other hazardous properties of any explosive nuclear assembly or nuclear component thereof,
- g) pressure waves caused by aircraft or other aerial devices travelling at sonic or supersonic speeds,
- h) riot, commotion or disorder, unless solely restricted to employees of the Contractor or of his Subcontractors and arising from the conduct of the Works,
- i) loss or damage due to the use or occupation by the Employer of any Section or part of the Permanent Works, except as may be provided for in the Contract,
- j) loss or damage to the extent that it is due to the design of the Works, and
- k) any operation of the forces of nature (insofar as it occurs on the Site) that an experienced contractor:
 - (i) could not have reasonably foreseen, or
 - (ii) could reasonably have foreseen, but against which he could not reasonably have taken at least one of the following measures:
 - (a) prevent loss or damage to physical property from occurring by taking appropriate measures, or
 - (b) insure against such loss or damage.

2.3 **Right of Access to the Site**

The Employer shall give the Contractor right of access to and possession of, all parts of the Site within the time (or times) stated in the SCC. The right and possession may not be exclusive to the Contractor. If, under the Contract, the Employer is required to give (to the Contractor) possession of any foundation, structure, plant or means of access, the Employer shall do so in the time and manner stated in the Specification. However, the Employer may withhold any such right or possession until the Performance Security has been received

If no such time is stated in the SCC, the Employer shall give the Contractor right of access to, and possession of, the Site within such times as may be required to enable the Contractor to proceed in accordance with the programme submitted. The same shall be handed over to the employer

If the Contractor suffers delay and/or incurs Cost as a result of a failure by the Employer to give any such right or possession within such time, the Contractor shall give notice to the EMPLOYER/ ENGINEER and shall be entitled to

- a. an extension of time for any such delay, if completion is or will be delayed
- b. Payment of any such Cost plus reasonable profit, which shall be included in the Contract Price.

After receiving this notice, the EMPLOYER/ENGINEER shall proceed to agree or determine these matters.

However, if and to the extent that the Employer's failure was caused by any error or delay by the Contractor, including an error in, or delay in the submission of, any of the Contractor's Documents, the Contractor shall not be entitled to such extension of time Cost or profit.

2.4 **Permits, Licenses or Approvals**

The Employer shall (where he is in a position to do so) provide reasonable assistance to facilitate the Contractor at the request of the Contractor but without holding any liability to do so towards the contractor:

- a. by obtaining copies of the Laws of the Country which are relevant to the Contract but are not readily available, and

-
- b. for the Contractor's applications for any permits, Licences or approvals required by the Laws of the Country:
 - c. for the delivery of Goods, including clearance through customs, and
 - d. for the export of Contractors Equipment when it is removed from the Site.

All cost related to obtaining of such permits, licenses and approvals shall be borne by the contractor.

2.5 Employer's Claims

If the Employer considers himself to be entitled to any payment under any Clause of these Conditions or otherwise in connection with the Contract, the Employer or the Employer shall give notice and particulars to the Contractor. However, notice is not required for payments due. The notice shall be given as soon as practicable after the Employer became aware of the event or circumstances giving rise to the claim.

The particulars shall specify the Clause or other basis of the claim, and shall include substantiation of the amount and/or extension to which the Employer considers himself to be entitled in connection with the Contract. Employer shall then proceed in accordance with the amount (if any) which the Employer is entitled to be paid by the Contractor. This amount may be included as a deduction in the Contract Price and Payment Certificates. The Employer shall only be entitled to set off against or make any deduction from an amount certified in a Payment Certificate, or to otherwise claim against the Contractor.

3 Engineer / Engineer-in-charge / EIC

3.1 Engineer's Duties and Authority

The Employer shall appoint the Engineer who shall carry out duties assigned to him in the Contract. The Engineer's staff shall include suitably qualified engineers and other professionals who are competent to carry out his duties. The Engineer shall have no authority to amend the Contract. The Engineer shall have the following roles and responsibilities.

3.1.1 The Engineer shall carry out the duties specified in the Contract.

3.1.2 The Engineer may exercise the authority specified in or necessarily to be implied from the Contract. However, he should obtain the specific approval of the Employer before exercising any such authority; particulars of such requirements are as follows :-

-
- 3.1.2.1 consenting to the sub-contracting of any part of the Works under Clause 5;
- 3.1.2.2 certifying additional cost determined under Clause 4.7;
- 3.1.2.3 determining an extension of time under sub clause 8.6, 8.7 and 8.8 of Clause 8;
- 3.1.2.4 issuing a variation under sub clause 12.1 and 12.2 of clause 12, except:

- (i) in an emergency situation, as reasonably determined by the Engineer;
- or
- (ii) if such variation would increase or decrease the quantity of allied items by less than the percentage permitted as per SCC or;

- 3.1.2.5 Fixing rates or prices under sub clause 12.3, 12.4 and 12.5 of clause 12.

Provided further that any requisite approval shall be deemed to have been given by the Employer for any such authority exercised by the Engineer.

- 3.1.2.6 Except as expressly stated in the Contract, the Engineer shall have no authority to relieve the Contractor of any of his obligations under the Contract.

3.2 Engineer's Representative

The Engineer's Representative shall be appointed by and be responsible to the Engineer and shall carry out such duties and exercise such authority as may be delegated to him by the Engineer under Sub-Clause 3.3.

3.3 Engineer's Authority to Delegate

Any communication given by the Engineer's Representative to the Contractor in accordance with such delegation shall have the same effect as though it had been given by the Engineer. Provided that:

- (a) Any failure of the Engineer's Representative to disapprove any work, materials or Plant shall not prejudice the authority of the Engineer to disapprove such work, materials or Plant and to give instructions for the rectification thereof, and
- (b) If the Contractor questions any communication of the Engineer's Representative he may refer the matter to the Engineer who shall confirm, reverse or vary the contents of such communication.

3.4 Appointment of Assistants

The Engineer or the Engineer's Representative may appoint any number of persons to assist the Engineer's Representative in the carrying out of his duties under Sub-Clause 3.2. He shall notify to the Contractor the names, duties and scope of authority of such persons. Such assistants shall have no authority to issue any instructions to the Contractor save in so far as such instructions may be necessary to enable them to carry out their duties and to secure their acceptance of materials, Plant or workmanship as being in accordance with the Contract, and any instructions given by any of them for those purposes shall be deemed to have been given by the Engineer's Representative.

3.5 **Instructions in Writing**

Instructions given by the Engineer shall be in writing, provided that if for any reason the Engineer considers it necessary to give any such instruction orally, the Contractor shall comply with such instruction. Confirmation in writing of such oral instruction given by the Engineer, whether before or after the carrying out of the instruction, shall be deemed to be an instruction within the meaning of this Sub-Clause. Provided further that if the Contractor, within 7 days, confirms in writing to the Engineer any oral instruction of the Engineer and such confirmation is not contradicted in writing within 7 days by the Engineer, it shall be deemed to be an instruction of the Engineer.

3.6 **Engineer to Act Impartially**

Wherever, under the Contract, the Engineer is required to exercise his discretion by:

- (a) Giving his decision, opinion or consent,
- (b) Expressing his satisfaction or approval,
- (c) Determining value, or
- (d) Otherwise taking action which may affect the rights and obligations of the Employer or the Contractor

He shall exercise such discretion impartially within the terms of the Contract and having regard to all the circumstances. Any such decision, opinion, consent, expression of satisfaction, or approval, determination of value or action may be opened up, reviewed or revised as provided in Clause 15.3.1.

3.7 **Engineer at liberty to object**

The Engineer shall be at liberty to object to and require the Contractor to remove forthwith from the Works any person provided by the Contractor who, in the opinion

of the Engineer, misconducts himself, or is incompetent or negligent in the proper performance of his duties, or whose presence on Site is otherwise considered by the Engineer to be undesirable, and such person shall not be again allowed upon the Works without the consent of the Engineer. Any person so removed from the Works shall be replaced as soon as possible.

4 Contractor

4.1 Contractor's General Responsibilities

The Contractor shall, with due care and diligence, execute and complete the Works and remedy any defects therein in accordance with the provisions of the Contract. The Contractor shall provide all superintendence, labour, materials, Plant, Contractor's Equipment and all other things, whether of a temporary or permanent nature, required in and for such execution, completion and remedying of any defects, so far as the necessity for providing the same is specified in or is reasonably to be inferred from the Contract.

The Contractor shall give prompt notice to the Engineer, with a copy to the Employer, of any error, omission, fault or other defect in the design of or Specification for the Works which he discovers when reviewing the Contract or executing the Works.

4.2 Site Operations and Methods of Construction

The Contractor shall take full responsibility for the adequacy, stability and safety of all Site operations and methods of construction. Provided that the Contractor shall not be responsible (except as stated hereunder or as may be otherwise agreed) for the design or specification of Permanent Works, or for the design or specification of any Temporary Works not prepared by the Contractor. Where the Contract expressly provides that part of the Permanent Works shall be designed by the Contractor, he shall be fully responsible for that part of such Works, notwithstanding any approval by the Engineer.

4.3 Contract Agreement

- 4.3.1 The Contractor shall, if called upon so to do, enter into and execute the Contract Agreement, to be prepared and completed at the cost of the Employer, in the form annexed to these Conditions with such modification as may be necessary. ~~For Joint Venture Bidder, the Parties shall enter into a Contract Agreement within 45 days after~~

~~the date of issue of the Letter of Award~~ & for single entity Bidder, the Party shall enter into a Contract Agreement within 28 days after the date of issue of the Letter of Award.

4.3.2 The Contractor shall be furnished free of charge certified true copy of the contract document.

4.3.3 A copy of the Contract Document furnished to the Contractor as aforesaid shall be kept by the Contractor on the Site in good condition and the same shall at all reasonable time be available for inspection and use by the Engineer-in-Charge, his representatives or by other Inspecting officers of the Authority.

4.3.4 None of these Documents shall be used by the Contractor for any purpose other than that of this contract.

4.4 **Performance Guarantee and security deposit**

4.4.1 **Performance Guarantee**

4.4.1.1 **For all Bidders including MSME Registered Firms**

The contractor shall be required to deposit an amount equal to 5% of the contract value of the work as performance guarantee in the form of irrevocable bank guarantee bond of any scheduled bank or State Bank of India in accordance with the form prescribed within 21 days of the issue of the work order/LOA for single entity ~~and within 35 days of the issue of the work order/LOA for JV~~. The performance guarantee shall be issued by a scheduled or nationalized bank in India.

4.4.1.2 Without limitation to the provisions of the preceding paragraph, whenever the Engineer determines an addition to the Contract Price as a result of a change in cost and/or legislation or as a result of a variation amounting to more than 20 percent of the portion of the Contract Price, the Contractor, at the Engineer's written request, shall promptly increase the value of the performance security proportionately and furnish additional performance security, if any, arising out of provisions mentioned herein. The cost of complying with the requirements of this clause shall be borne by the contractor.

4.4.1.3 **Additional Performance Bank Guarantee against unbalanced rate quotations**

For Tenders having financial quote up to $\pm 10\%$ of the estimated contract value, no additional security deposit is required. But for tenders having financial quote within $\pm 10\%$ and $\pm 20\%$ of the estimated contract value, the contractor is liable to provide

additional BG against unbalanced rate which would be communicated in LOA. The additional BG defined herein shall be over and above the performance security and shall be return after issuance of completion certificate by EIC. The additional performance bank guarantee shall be valid one month beyond the completion of work. However, non-furnishing of additional BG within the stipulated time of LOA shall be treated as default and consequently, the tender shall be cancelled with forfeiture of EMD.

For tenders having financial quote beyond - 20% of the estimated contract value, the bidder shall furnish full justification for the quote to satisfy that rates quoted are workable, however decision of the Authority in this regard shall be final and binding upon the bidder with conditions imposed if any (Other than additional BG) and offer for consent would be given to the bidder.

4.4.1.4 The Performance Guarantee shall be valid one month beyond the work period until the Contractor has executed & completed the Works, remedied any defects therein in accordance with the Contract. No claim shall be made against such security and such security shall be returned to the Contractor within 21 days after completion of Defect Liability Period. In case the extension of time for completion with or without LD, the contractor shall get the validity of the performance guarantee extended to cover such extension of time of the work.

4.4.2 **Security Deposit**

4.4.2.1 A sum @ 10% of the net amount of the bill shall be deducted from each running bill of the contractor till the sum along with the sum already deposited in cash/RTGS as the earnest money, will amount to security deposit of 5% of the contract value of work. The earnest money deposited in the form of Bank guarantee shall be returned to the contractor after receiving the Performance Bank Guarantee.

In case of MSE registered firms, deduction of a sum of 10% of the net amount of the bill from each running bill till that amount reaches 5% of the contract value of the work as Security Deposit will also be made.

4.4.2.2 The total security deposit shall remain with IWAI till the completion of the contract or the payment of the final bill payable in accordance with agreement condition whichever is later, provided the Engineer-in-Charge is satisfied that there is no demand outstanding against the contractor.

4.4.2.3 No interest will be paid on security deposit.

4.4.2.4 If the contractor neglects to observe or fails to perform any of his obligations under the contract, it shall be lawful for the Employer/ EIC to forfeit either in whole or in part, the security deposit furnished by the contractor. However, if the contractor duly performs and completes the contract in all respects and presents in absolute "NO DEMAND CERTIFICATE" in the prescribed form, IWAI shall refund the security deposit to the contractor after deduction of cost and expenses that the Authority may have incurred and other money including all losses and damages which the Authority is entitled to recover from the Contractor.

4.4.2.5 In case of delay in the progress of work, the Engineer- in-Charge shall issue to the contractor a memo in writing pointing out the delay in progress and calling upon the contractor to explain the causes for the delay within 3 days of receipt of the memo and 10 days from issuance of memo whichever is earlier. If the Engineer-in-Charge is not satisfied with the explanations offered, he may forfeit the security deposit and / or withhold payment of pending bills in whole or in part and/ or get the measures of rectification of progress of work accelerated to the pre-defined level at the risk and cost of the contractor.

4.4.2.6 All compensation or other sums of money payable by the contractor under the terms of the contract or any other contract or on any other account whatsoever, may be deducted from or paid by the sale of a sufficient part of his security or from any sums which may be due or may become due to the contractor by the Authority on any account whatsoever. Also in the event of the contractor's security deposit being reduced by reasons of such deductions or sale, as aforesaid the contractor shall, within 14 days of receipt of notice of demand from the Engineer-in-Charge make good the deficit in his security deposit.

4.4.2.7 In case the contractor fails to commence the work or when the contractor has defaulted for more than thirty days or when any amount is to be recovered from the contractor as penalty or deduction and the contractor fails to remit such amount even after due notice is given to him in this regard, IWAI at its own discretion may en-cash the Bank Guarantee furnished as performance guarantee and /or recover the sum from his security deposit.

4.5 **Inspection of Site**

The Employer shall have made available to the Contractor, before the submission by the Contractor of the Tender, such available data on hydrological and hydrographical, results of rock testing, surface soil testing, bore hole data at the proposed terminal locations, as have been obtained by or on behalf of the Employer from investigations undertaken relevant to the Works but the Contractor shall be responsible for his own interpretation thereof.

The Contractor acknowledges that it has inspected and examined the Site and its surroundings and information available in connection therewith and to have satisfied himself (so far as is practicable, having regard to considerations of cost and time) before submitting his Tender, as to:

- a) The form and nature thereof, including the sub-surface conditions,
- b) The hydrological, hydrographical and climatic conditions,
- c) The extent and nature of work and materials necessary for the execution and completion of the works and the remedying of any defects therein, and
- d) The means of access to the site and the accommodation he may require,
- e) Power, water, fuel and other supplies he may require
- f) The infrastructure for transportation of men and material along the project corridor
- g) Market rates of the items in the working country
- h) Medical facilities and
- i) General safety & security of project area and
- j) The Laws, procedures and labour practices of the Country

and, in general, shall be deemed to have obtained all necessary information, subject as above mentioned, as to risks, contingencies and all other circumstances which may influence or affect his Tender. The Contractor shall be deemed to have based his Tender on the data made available by the Employer and on his own inspection and examination, all as aforementioned.

4.6 Sufficiency of Tender

The Contractor shall be deemed to have satisfied himself as to the correctness and sufficiency of the Tender and of the rates and prices stated in the Bill of Quantities, all of which shall, except insofar as it is otherwise provided in the Contract, cover all his

obligations under the Contract (including those in respect of the supply of goods, materials, Plant or services or of contingencies) and all matters and things necessary for the proper execution and completion of the Works and the remedying of any defects therein.

4.7 Unforeseeable Physical Obstructions or Conditions

If, however, during the execution of the Works the Contractor encounters physical obstructions or physical conditions, other than climatic, sea, river conditions on the Site, such obstructions or conditions were, in his opinion, not foreseeable by an experienced contractor, the Contractor shall forthwith give notice thereof to the Engineer, with a copy to the Employer. On receipt of such notice, the Engineer shall, if in his opinion such obstructions or conditions could not have been reasonably foreseen by an experienced contractor, after due consultation with the Employer and the Contractor, determine

- a. Any extension of time to which the Contractor is entitled under sub clause 8.6, 8.7 and 8.8 of clause 8, and
- b. The amount of any costs which may have been incurred by the Contractor by reason of such obstructions or conditions having been encountered, which shall be added to the Contract Price, and shall notify the Contractor accordingly, with a copy to the Employer. Such determination shall take account of any instruction which the Engineer may issue to the Contractor in connection therewith, and any proper and reasonable measures acceptable to the Engineer which the Contractor may take in the absence of specific instructions from the Engineer.

4.8 Work to be in Accordance with Contract

Unless it is legally or physically impossible, the Contractor shall execute and complete the Works and remedy any defects therein in strict accordance with the Contract to the satisfaction of the Engineer. The Contractor shall comply with and adhere strictly to the Engineer's instructions on any matter, whether mentioned in the Contract or not, touching or concerning the Works. The Contractor shall take instructions only from the Engineer (or his Representatives or Assistants)

4.9 Contractor's Programme

4.9.1 The Contractor shall, within the time stated in the SCC, after the date of issue of the Letter of Award, submit to the Engineer for his consent a programme, in such form and detail as the Engineer shall reasonably prescribe, for the execution of the Works. The Contractor shall, whenever required by the Engineer, also provide in writing for his information a general description of the arrangements and methods which the Contractor proposes to adopt for the execution of the Works.

4.9.2 Revised Programme

If at any time it should appear to the Engineer that the actual progress of the Works does not conform to the programme to which consent has been given under Sub-Clause 4.9.1, the Contractor shall produce, at the request of the Engineer, a revised programme showing the modifications to such programme necessary to ensure completion of the Works within the Time for Completion.

4.9.3 Cash Flow Estimate to be submitted

The Contractor shall, within the time stated in the SCC, after the signing of Agreement, provide to the Engineer for his information a detailed 3 months rolling cash flow, of all payments to which the Contractor will be entitled under the Contract and the Contractor shall subsequently supply revised cash flow estimates at quarterly intervals, if required to do so by the Engineer.

4.9.4 Contractor not relieved of Duties or Responsibilities

The submission to and consent by the Engineer of such programmes or the provision of such general descriptions or cash flow estimates shall not relieve the Contractor of any of his duties or responsibilities under the Contract.

4.10 Contractor's Superintendence

The Contractor shall provide all necessary superintendence during the execution of the Works and as long thereafter as the Engineer may consider necessary for the proper fulfilling of the Contractor's obligations under the Contract. The Contractor, or a competent and authorised representative approved of by the Engineer, which approval may at any time be withdrawn, shall give his whole time to the superintendence of the Works. Such authorised representative shall receive, on behalf of the Contractor, instructions from the Engineer.

If approval of the representative is withdrawn by the Engineer, the Contractor shall, as soon as is practicable, having regard to the requirement of replacing him as hereinafter mentioned, after receiving notice of such withdrawal, remove the representative from the Works and shall not thereafter employ him again on the Works in any capacity and shall replace him by another representative approved by the Engineer.

4.11 Contractor's Employees

The Contractor shall provide on the Site in connection with the execution and completion of the Works and the remedying of any defects therein

- (a) only such technical personnel as are skilled and experienced in their respective callings and such foremen and leading hands as are competent to give proper superintendence of the Works, and
- (b) such skilled, semi-skilled and unskilled labour as is necessary for the proper and timely fulfilling of the Contractor's obligations under the Contract.

4.12 Setting out

The Contractor shall be responsible for:

- (a) the accurate setting-out of the Works in relation to original points, lines and levels of reference given by the Engineer in writing,
- (b) the correctness, subject as above mentioned, of the position, levels, dimensions and alignment of all parts of the Works, and
- (c) the provision of all necessary instruments, appliances and labour in connection with the foregoing responsibilities.

If, at any time during the execution of the Works, any error appears in the position, levels, dimensions or alignment of any part of the Works, the Contractor, on being required so to do by the Engineer, shall, at his own cost, rectify such error to the satisfaction of the Engineer.

The checking of any setting-out or of any line or level by the Engineer shall not in any way relieve the Contractor of his responsibility for the accuracy thereof and the Contractor shall carefully protect and preserve all bench-marks, sight-rails, pegs and other things used in setting-out the Works.

4.13 **Safety and Security**

The Contractor shall, throughout the execution and completion of the Works and the remedying of any defects therein:

- (a) have full regard for the safety of all persons entitled to be upon the Site and keep the Site (so far as the same is under his control) and the Works (so far as the same are not completed or occupied by the Employer) in an orderly state appropriate to the avoidance of danger to such persons,
- (b) provide and maintain at his own cost all lights, guards, fencing, warning signs and watching, when and where necessary or required by the Engineer or by any duly constituted authority, for the protection of the Works or for the safety and convenience of the public or others, and

4.14 **Electricity, Water and Gas**

The Contractor shall be responsible for the provision of all power, water and other services he may require for his execution of the Works.

4.15 **Protection of the Environment**

The Contractor shall take all reasonable steps to protect the environment (both on and off the Site) and to limit damage and nuisance to people and property resulting from pollution, noise and other results of his operations.

The Contractor shall ensure that emissions, surface discharges and effluent from the Contractor's activities shall not exceed the permissible / acceptable values, and shall not exceed the values prescribed by applicable Laws. The Contractor is required to establish and operate with suitably qualified personnel a system for monitoring the environmental factors that may be directly impacted by the Works and make available such records for inspection of Engineer or duly authorized representatives of Government of the country in which Works are executed as and when so required.

4.16 **Care of Works**

The Contractor shall take full responsibility for the care of the Works and materials and Plant for incorporation therein from the Commencement Date until the date of issue of the Completion certificate for the whole of the Works, when the responsibility for the said care shall pass to the Employer. Provided that:

-
- (a) if the Engineer issues a Completion certificate for any Section or part of the Permanent Works, the Contractor shall cease to be liable for the care of that Section or part from the date of issue of the Completion certificate, when the responsibility for the care of that Section or part shall pass to the Employer, and
 - (b) The Contractor shall take full responsibility for the care of any outstanding Works and materials and Plant for incorporation therein which he undertakes to finish during the maintenance period until such outstanding Works have been completed pursuant to Clause 10.

4.17 Responsibility to Rectify Loss or Damage

If any loss or damage happens to the Works, or any part thereof, or materials or Plant for incorporation therein, during the period for which the Contractor is responsible for the care thereof, from any cause whatsoever, other than the risks defined in Sub-Clause 2.2, the Contractor shall, at his own cost, rectify such loss or damage so that the Permanent Works conform in every respect with the provisions of the Contract to the satisfaction of the Engineer. The Contractor shall also be liable for any loss or damage to the Works occasioned by him in the course of any operations carried out by him for the purpose of complying with his obligations under Clauses 11.

4.18 Loss or Damage Due to Employer's Risks

In the event of any such loss or damage happening from any of the risks defined in Sub-Clause 2.2, or in combination with other risks, the Contractor shall, if and to the extent required by the Engineer, rectify the loss or damage and the Engineer shall determine an addition to the Contract Price in accordance with Clause 12.3, 12.4 and 12.5 and shall notify the Contractor accordingly, with a copy to the Employer. In the case of a combination of risks causing loss or damage any such determination shall take into account the proportional responsibility of the Contractor and the Employer.

4.19 Compliance with Statutes, Regulations

The Contractor shall conform in all respects, including by the giving of all notices and the paying of all fees, with the provisions of:

- (a) any National or State Statute, Ordinance, or other Law, or any regulation, or bye-law of any local or other duly constituted authority in relation to the

execution and completion of the Works and the remedying of any defects therein, and

- (b) the rules and regulations of all public bodies and companies whose property or rights are affected or may be affected in any way by the Works, and the Contractor shall keep the Employer indemnified against all penalties and liability of every kind for breach of any such provisions. Provided always that the Employer shall be responsible for obtaining any planning, zoning or other similar permission required for the Works to proceed and shall indemnify the Contractor in accordance with Sub-Clause 20.7.

4.20 Fossils

The Contractor shall take reasonable precautions to prevent his workmen or any other persons from removing or damaging all fossils, coins, articles of value or antiquity and structures and other remains or things of geological or archaeological interest discovered on the Site. The Contractor immediately upon discovery thereof and before removal, acquaint the Engineer of such discovery and carry out the Engineer's instructions for dealing with the same. If, by reason of such instructions, the Contractor suffers delay and/or incurs costs then the Engineer shall, after due consultation with the Employer and the Contractor, determine:

- (a) any extension of time to which the Contractor is entitled under sub clause 8.6, 8.7 and 8.8 of clause 8 , and
- (b) the amount of such costs, which shall be added to the Contract Price, and shall notify the Contractor accordingly, with a copy to the Employer.

4.21 Patent Rights

The Contractor shall save harmless and indemnify the Employer from and against all claims and proceedings for or on account of infringement of any patent rights, design trademark or name or other protected rights in respect of any Contractor's Equipment, materials or Plant used for or in connection with or for incorporation in the Works and from and against all damages, costs, charges and expenses whatsoever in respect thereof or in relation thereto, except where such infringement results from compliance with the design or Specification provided by the Engineer.

4.22 Copy Right

The copyright in all drawings, documents and other materials containing data and information furnished to the Employer by the Contractor herein shall remain vested in the Contractor or, if they are furnished to the Employer directly or through the Contractor by any third party, including suppliers of materials, the copyright in such materials shall remain vested in such third party indemnity of the employer.

4.23 **Royalties**

Except where otherwise stated, the Contractor shall pay all tonnage and other royalties, rent and other payments or compensation, if any, for getting stone, sand, gravel, clay or other materials required for the Works as per governing laws.

4.24 **Interference with Traffic and Adjoining Properties**

All operations necessary for the execution and completion of the Works and the remedying of any defects therein shall, so far as compliance with the requirements of the Contract permits, be carried on so as not to interfere unnecessarily or improperly with:

- (a) the convenience of the public, or
- (b) the access to, use and occupation of public or private roads and footpaths to or of properties whether in the possession of the Employer or of any other person.

The Contractor shall save harmless and indemnify the Employer in respect of all claims, proceedings, damages, costs, charges and expenses whatsoever arising out of, or in relation to, any such matters insofar as the Contractor is responsible therefor.

4.25 **Avoidance of Damage to Roads and navigation aids, temporary structure/permanent structure.**

The Contractor shall use every reasonable means to prevent any of the roads or bridge jetties, wharfs or river channels, temporary berths for inland vessels, communicating with or on the routes to the Site from being damaged or injured by any traffic of the Contractor or any of his Subcontractors and, in particular, shall select routes, choose and use vehicles and restrict and distribute loads so that any such extraordinary traffic as will inevitably arise from the moving of materials, Plant, Contractor's Equipment or Temporary Works from and to the Site shall be limited, as far as reasonably possible, and so that no unnecessary damage or injury may be occasioned to such

roads and bridges or other structures. However, if any claim arises regarding damage, maintenance/repairs/reconstruction/replacement would be contractor's liability.

4.26 **Transport of Contractor's Equipment or Temporary Works**

Save insofar as the Contract otherwise provides, the Contractor shall be responsible for and shall pay the cost of strengthening any bridges, jetties, wharfs or altering or improving any road or river channels, temporary berths for inland vessels, communicating with or on the routes to the Site to facilitate the movement of Contractor's Equipment or Temporary Works and the Contractor shall indemnify and keep indemnified the Employer against all claims for damage to any such road or bridge or other structures caused by such movement, including such claims as may be made directly against the Employer, and shall negotiate and pay all claims arising solely out of such damage, the costs of which are deemed to be included in the contract price. The Contractor shall be responsible for packing, loading, transporting, receiving, unloading, storing and protecting all Goods and other things required for the Works

4.27 **Transport of Materials or Plant**

If, notwithstanding Sub-Clause 4.25, any damage occurs to any bridge or road or structure jetties, wharfs or river channels, temporary berths for communicating with or on the routes to the Site arising from the transport of materials or Plant, the Contractor shall notify the Engineer with a copy to the Employer, as soon as he becomes aware of such damage or as soon as he receives any claim from the authority entitled to make such claim. In such cases the Contractor shall negotiate the settlement of and pay all sums due in respect of such claim and shall indemnify the Employer in respect thereof and in respect of all claims, proceedings, damages, costs, charges and expenses in relation thereto. Provided that if and so far as any such claim or part thereof is, in the opinion of the Engineer, due to any failure on the part of the Contractor to observe and perform his obligations under Sub-Clause 4.25, and the Contractor fails to take adequate steps to settle any claims arising, the Engineer will be at liberty to negotiate with such claimant and pay for damages which shall be recoverable from the Contractor by the Employer and may be deducted by the Employer from any monies due or to become due to the Contractor and the Engineer shall notify the Contractor accordingly, with a copy to the Employer. The Contractor

shall give the Employer not less than 21 days' notice of the date on which any Equipment, Plant or a major item of other Goods will be delivered to the Site;

4.28 Waterborne Traffic

Where the nature of the Works is such as to require the use by the Contractor of waterborne transport, the foregoing provisions of this Clause shall be construed as though "road" included a lock, dock, sea wall or other structure related to a waterway and "vehicle" included craft, and shall have effect accordingly.

4.29 Opportunities for Other Contractors

The Contractor shall, in accordance with the requirements of the Engineer, afford all reasonable opportunities for carrying out their work to:

- (a) any other contractors employed by the Employer and their workmen
- (b) the workmen of the Employer, and
- (c) the workmen of any duly constituted authorities who may be employed in the execution on or near the Site of any work not included in the Contract or of any contract which the Employer may enter into in connection with or ancillary to the Works.

4.30 Facilities for Other Contractors

If however, pursuant to Sub-Clause 4.29 the Contractor shall, on the written request of the Engineer:

- (a) make available to any such other contractor, or to the Employer or any such authority, any roads or ways for the maintenance of which the Contractor is responsible,
- (b) permit the use, by any such, of Temporary Works or Contractor's Equipment on the Site, or
- (c) provide any other service of whatsoever nature for any such, the Engineer shall determine an addition to the Contract Price in accordance with Clauses 12.3,12.4 and 12.5 and shall notify the Contractor accordingly, with a copy to the Employer.

4.31 Contractor to Keep Site Clear

During the execution of the Works the Contractor shall keep the Site reasonably free from all unnecessary obstruction and shall store or dispose off any Contractor's Equipment and surplus materials and clear away and remove from the Site any wreckage, rubbish or Temporary Works no longer required.

4.32 Clearance of Site on Completion

Prior to the issue of any Completion certificate the Contractor shall clear away and remove from that part of the Site to which such Completion certificate relates all Contractor's Equipment, surplus material, rubbish and Temporary Works of every kind, and leave such part of the Site and Works clean and in a workmanlike condition to the satisfaction of the Engineer. Provided that the Contractor shall be entitled to retain on Site, until the end of the maintenance period, such materials, Contractor's Equipment and Temporary Works as are required by him for the purpose of fulfilling his obligations during the maintenance period.

4.33 Language Ability of Superintending Staff

A reasonable proportion of the Contractor's superintending staff shall have a working knowledge of the local language of the Site and English language, or the Contractor shall have available on site at all times a sufficient number of competent interpreters to ensure the proper transmission of instructions and information.

4.34 Employment of Local Personnel

The Contractor is encouraged, to the extent practicable and reasonable, to employ staff and labour with appropriate qualifications and experience from sources within the country of the Employer and the country/place where the Work is executed.

4.35 Boreholes and Exploratory Excavation

In respect of Works which the Contractor is required to execute, install and construct to the requirements of Employer, any boreholes or exploratory excavation that may be required to be undertaken before commencement or during execution of Works will have to be carried out by the Contractor at no extra cost.

4.36 Contractor's Equipment, Temporary Works and Materials

4.36.1 Contractor's Equipment, Temporary Works and Materials; Exclusive Use for the Works

All Contractor's Equipment, Temporary Works and materials provided by the Contractor shall, when brought on to the Site, be deemed to be exclusively intended for the execution of the Works and the Contractor shall not remove the same or any part thereof, except for the purpose of moving it from one part of the Site to another, without the consent of the Engineer. Provided that consent shall not be required for vehicles, floating crafts engaged in transportation of staff, labour, Contractor's Equipment, Temporary Works, Plant or materials to or from the Site.

4.36.2 Employer not Liable for Damage

The Employer shall not at any time be liable, as mentioned in Clauses 2.2, 4.16,4.17,4.18 and 13, for the loss of or damage to any of the said Contractor's Equipment, Temporary Works or materials.

4.36.3 Customs Clearance

The Employer will use his best endeavours in assisting the Contractor, where required, in obtaining clearance through the Customs of Contractor's Equipment, materials and other things required for the Works. The provisions contained in the Framework Agreement shall apply.

4.36.4 Re-export of Contractor's Equipment

In respect of any Contractor's Equipment which the Contractor has imported for the purposes of the Works, the Employer will use his best endeavours to assist the Contractor, where required, in procuring any necessary Government consent to the re-export of such Contractor's Equipment by the Contractor upon the removal thereof pursuant to the terms of the Contract and in accordance with the provisions contained in the Framework agreement.

4.36.5 Conditions of Hire of Contractor's Equipment

With a view to securing, in the event of termination under Clause 16, the continued availability, for the purpose of executing the Works, of any hired Contractor's Equipment, the Contractor shall not remove or withdraw any of such equipment, materials, temporary works or plant from the site without obtaining written permission to do so issued by the Engineer. Employer shall be entitled to permit the use thereof by any other contractor employed by him for the purpose of executing and

completing the Works and remedying any defects therein, under the terms of the said Clause 16.

4.36.6 Costs for the Purpose of Clause 16

In the event of the Employer invoking provisions of sub clause 4.36.5, for the purpose of executing and completing the Works and the remedying of any defects therein for the purpose of clause 16, the costs thereof will be determined by the Engineer in consultation with the employer and same shall form the cost of executing and completing same as incomplete obligation and liability of the Contractor and notice to that effect will be issued to the Contractor by the Engineer.

4.36.7 Incorporation of Clause in Subcontracts

The Contractor shall, where entering into any subcontract for the execution of any part of the Works, incorporate in such subcontract (by reference or otherwise) the provisions of sub clauses 4.36.5 and 4.36.6 in relation to Contractor's Equipment, Temporary Works or materials brought on to the Site by the Subcontractor and employer shall be kept indemnified against any claim arising out of such subcontractor.

4.36.8 Co-operation

The Contractor shall, as specified in the Contract or as instructed by the Engineer, allow appropriate opportunities for carrying out work to:

- a) the Employer's Personnel,
- b) any other contractors employed by the Employer, and
- c) the personnel of any legally constituted public authorities,

who may be employed in the execution on or near the Site of any work not included in the Contract. Any such instruction shall constitute a Variation if and to the extent that it causes the Contractor to incur Unforeseeable Cost. Services for these personnel and other contractors may include the use of Contractor's Equipment, Temporary Works or access arrangements, which are the responsibility of the Contractor.

If, under the Contract, the Employer is required to give to the Contractor possession of any foundation, structure, plant or means of access in accordance with Contractor's

Documents, the Contractor shall submit such documents to the EMPLOYER/ENGINEER in the time and manner stated in the Specification.

5 Assignment and Subcontracting

5.1 Assignment of Contract

5.2 The Contractor shall not, without the prior consent of the Employer (which consent shall be at the sole discretion of the Employer), assign the Contract or any part thereof, or any benefit or interest therein or thereunder.

5.3 Subcontracting

The Contractor shall not subcontract the whole of the Works. Except where otherwise provided by the Contract, the Contractor shall not subcontract any part of the Works without the prior consent of the Employer conveyed through the Engineer. A subcontractor under the Contract must be a firm or person or entity that satisfies the relevant provisions of the Framework Agreement. Any such consent shall not relieve the Contractor from any liability or obligation under the Contract and he shall be responsible for the acts, defaults and neglects of any Subcontractor, his agents, servants or workmen as fully as if they were the acts, defaults or neglects of the Contractor, his agents, servants or workmen. The work sub-contracted shall not be more than 15% of the contract value. If the Engineer gives his consent to the contractor to subcontract part of the work and the value of such work is more than 10% of the contract amount, the sub-contractor shall have to submit all relevant documents, as stipulated in ITB of this tender document which in turn shall be evaluated to check the capacity/capability of the proposed sub-contractor to execute the work assigned to him. Failing to do so, the Engineer may, at his discretion, reject contractor's claim to subcontract the work to such sub-contractor.

Provided that the Contractor shall not be required to obtain such consent for:

- (a) The provision of labour,
- (b) The purchase of materials which are in accordance with the standards specified in the Contract, or
- (c) The subcontracting of any part of the Works for which the Subcontractor is named in the original Contract.

In all other cases, the Contractor shall give the Employer not less than 14 days' notice of ;

- (a) The intended appointment of the Subcontractor, with detailed particulars which shall include his relevant experience,
- (b) The intended commencement of the Subcontractor's work, and
- (c) The intended commencement of the Subcontractor's work on the site.

5.4 **Assignment of Subcontractors' Obligations**

In the event of a Subcontractor having undertaken towards the Contractor in respect of the work executed, or the goods, materials, Plant or services supplied by such Subcontractor, any continuing obligation extending for a period exceeding that of the maintenance period under the Contract, the Contractor shall at any time, after the expiration of such Period, assign to the Employer, at the Employer's request and cost, the benefit of such obligation for the unexpired duration thereof.

5.5 **Nominated Subcontractors**

5.4.1 **Definition of "Nominated Subcontractors"**

All specialists, merchants, tradesmen and others executing any work or supplying any goods, materials, Plant or services included in the Contract, who may have been or be nominated or selected or approved by the Employer or the Engineer, for the execution of such work or the supply of such goods, materials, Plant or services, be deemed to be subcontractors to the Contractor and are referred to in this Contract as "nominated Subcontractors".

5.4.2 **Nominated Subcontractors; Objection to Nomination**

The Contractor shall not be required by the Employer or the Engineer, or be deemed to be under any obligation, to employ any nominated Subcontractor against whom the Contractor may raise reasonable objection or who declines to enter into a subcontract with the Contractor containing provisions:

- (a) that in respect of the work, goods, materials, Plant or services the subject of the subcontract, the nominated Subcontractor will undertake towards the Contractor such obligations and liabilities as will enable the Contractor to discharge his own obligations and liabilities towards the Employer under the

terms of the Contract and will save harmless and indemnify the Contractor from and against the same and from all claims, proceedings, damages, costs, charges and expenses whatsoever arising out of or in connection therewith, or arising out of or in connection with any failure to perform such obligations or to fulfil such liabilities, and

- (b) that the nominated Subcontractor will keep harmless and indemnify the Contractor from and against any negligence by the nominated Subcontractor, his agents, workmen and servants and from and against any misuse by him or them of any Temporary Works provided by the Contractor for the purposes of the Contract and from all claims as aforesaid.

5.4.3 Design Requirements to be Expressly Stated

If in connection with any services to be provided in relation to execution of Works include any matter of design or specification of any part of the Permanent Works or of any Plant to be incorporated therein, such requirement shall be expressly stated in the Contract and shall be included in any nominated Subcontract. The nominated Subcontract shall specify that the nominated Subcontractor providing such services will keep harmless and indemnify the Contractor from and against the same and from all claims, proceedings, damages, costs, charges and expenses whatsoever arising out of or in connection with any failure to perform such obligations or to fulfil such liabilities.

5.4.4 Payments to Nominated Subcontractors

For all work executed or goods, materials, Plant or services supplied by any nominated Subcontractor, the Contractor shall be entitled to:

- (a) the actual price paid or due to be paid by the Contractor, on the instructions of the Engineer, and in accordance with the subcontract;
- (b) in respect of labour supplied by the Contractor, the sum, if any, entered in the Bill of Quantities or, if instructed by the Engineer pursuant to paragraph (a) of Sub-Clause 15.2.2, as may be determined in accordance with Clause 12.3, 12.4 and 12.5; and
- (c) in respect of all other charges and profit, a sum being a percentage rate of the actual price paid or due to be paid calculated, where provision has been made

in the Bill of Quantities for a rate to be set against the relevant Provisional Sum, at the rate inserted by the Contractor against that item or, where no such provision has been made, at the rate inserted by the Contractor in the SCC and repeated where provision for such is made in a special item provided in the Bill of Quantities for such purpose.

5.4.5 Certification of Payments to Nominated Subcontractors

Before issuing, under Clause 14, any certificate, which includes any payment in respect of work done or goods, materials, Plant or services supplied by any nominated Subcontractor, the Engineer shall be entitled to demand from the Contractor reasonable proof that all payments, less retentions, included in previous certificates in respect of the work or goods, materials, Plant or services of such nominated Subcontractor have been paid or discharged by the Contractor. If the Contractor fails to supply such proof then, unless the Contractor:

- (a) satisfies the Engineer in writing that he has reasonable cause for withholding or refusing to make such payments, and
- (b) produces to the Engineer reasonable proof that he has so informed such nominated Subcontractor in writing,

the Employer shall be entitled to pay to such nominated Subcontractor direct, upon the certificate of the Engineer, all payments, less retentions, provided for in the nominated Subcontract, which the Contractor has failed to make to such nominated Subcontractor and to deduct by way of set-off the amount so paid by the Employer from any sums due or to become due from the Employer to the Contractor.

Provided that, where the Engineer has certified and the Employer has paid direct as aforesaid, the Engineer shall, in issuing any further certificate in favour of the Contractor, deduct from the amount thereof the amount so paid, direct as aforesaid, but shall not withhold or delay the issue of the certificate itself when due to be issued under the terms of the Contract.

6 Staff & Labour

6.1 Engagement of Staff and Labour

The Contractor shall, unless otherwise provided in the Contract, make his own arrangements for the engagement of all staff and labour, local or other, and for their payment, housing, feeding and transport. In engagement of labour, the provisions in that respect contained in the Framework Agreement shall be fully complied with by the Contractor.

6.2 **Foreign staff, labour and Repatriation.**

The Contractor may import to the country where Works are executed any personnel who are necessary for the execution of Works. The Contractor must ensure that these personnel are provided with the required residence visas and work permits. The Contractor shall be responsible for the return to the place where they were recruited or to their domicile of all such persons as he recruited and employed for the purposes of or in connection with the contract and he shall maintain such persons as are to be so returned in a suitable manner until they shall have left the site.

6.3 **Housing for Labour**

Save insofar as the contract otherwise provides, the Contractor shall provide and maintain such accommodation and amenities as he may consider necessary for all his staff and labour, employed for the purposes of or in connection with the Contract, including all fencing, water supply (both for drinking and other purposes), electricity supply, sanitation, cookhouses, fire prevention and fire-fighting equipment, air conditioning, cookers, refrigerators, furniture and other requirements in connection with such accommodation or amenities. On completion of the Contract, unless otherwise agreed with the Employer, the temporary camps / housing provided by the Contractor shall be removed and the site reinstated to its original condition, all to the approval of the Engineer.

6.4 **Health and Safety**

Due precautions shall be taken by the contractor, and at his own cost, to ensure the safety of his staff and labour and, in collaboration with and to the requirements of the local health authorities, to ensure that medical staff, first aid equipment and store, sick bay and suitable ambulance service to the maximum extent the site conditions permit, are available at the camps, housing and on the Site at all times throughout the period of the contract and that suitable arrangements are made for the prevention of epidemics and for all necessary welfare and hygiene requirements.

6.5 **Measures against Insect and Pest Nuisance**

The Contractor shall at all times take the necessary precautions to protect all staff and labour employed on the site from insect nuisance, rats and other pests and reduce the dangers to health and the general nuisance occasioned by the same. The Contractor shall provide his staff and labour with suitable prophylactics for the prevention of malaria and take steps to prevent the formation of stagnant pools of water. He shall comply with all the regulations of the local health authorities in these respects and shall in particular arrange to spray thoroughly with approved insecticide all buildings erected on the Site. Such treatment shall be carried out at least once a year or as frequently as necessary or as instructed by the Engineer. The contractor shall warn his staff and labour of the dangers of hazardous flora and fauna within the project area.

6.6 **Epidemics**

In the event of any outbreak of illness of an epidemic nature, the contractor shall comply with and carry out such regulations, orders and requirements as may be made by the Government, or the local medical or sanitary authorities, for the purpose of dealing with and overcoming the same.

6.7 **Arms and ammunition**

The Contractor shall not give, barter or otherwise dispose of to any person, any arms or ammunitions of any kind, or allow Contractor's personnel to do so.

6.8 **Fair Wages**

The Contractor shall pay to labourer employed by him either directly or through sub-contractors wages not less than wages as defined in Minimum Wages Act 1948 and Contract Labour (Regulation and Abolition) Act 1970 amended from time to time and rules framed there-under and other labour laws affecting contract labour that may be brought in force from time to time.

In respect of labour directly or indirectly employed in the works, the contractor shall comply with the rules and regulations on the maintenance of suitable records prescribed for this purpose from time to time by the Government. He shall maintain his accounts and vouchers on the payment of wages to the labourers to the satisfaction of the Engineer. The Engineer shall have the right to call for such record as required

to satisfy himself on the payment of fair wages to the labourers and shall have the right to deduct from the contract amount a suitable amount for making good the loss suffered by the worker or workers by reason of the "fair wages" clause to the workers.

The contractor shall be primarily liable for all payments to be made and for the observance of the regulations framed by the Govt. from time to time without prejudice to his right to claim indemnity from his sub-contractors. Equal wages are to be paid for both men and women if the nature of work is same and similar.

6.9 Return of Labour and Contractor's Equipment

The Contractor shall, if required by the Engineer, deliver to the Engineer a return in detail, in such form and at such intervals as the Engineer may prescribe, showing the staff and the numbers of the several classes of labour from time to time employed by the Contractor on the Site and such information respecting Contractor's Equipment as the Engineer may require.

6.10 Child labour

The contractor shall not engage children below the age of 14, directly or indirectly, for the execution of this contract. Contractor shall observe compliance to all the acts pertaining to child labour, health & safety and any other such laws existing in the Employers country. If at any time children below the age of 14 are found to be engaged, directly or indirectly, by the contractor or his representatives, the contractor shall pay penalties imposed by concerned regulatory bodies for practicing child labour.

6.11 Removal of Contractor's men

The contractor shall employ for the execution of the works only such persons who are skilled and experienced in their respective trades and Engineer-in-charge shall be at liberty to object and to ask the contractor to remove from the works any persons employed by the contractor for the execution of the works who, in the opinion of the EIC, misconduct themselves or are incompetent or negligent in the proper performance of their duties. The contractor shall forthwith comply with such requisition and such persons shall not be again employed upon the works without the written permission of the EIC. Any person so removed from the work shall be immediately replaced at the expense of the contractor by a qualified and competent

substitute. Should the contractor be requested to repatriate any person removed from the work, he shall do so and shall bear all costs in connection herewith.

6.12 Replacement of Key Personnel

The replacement of the key personnel shall only be on health grounds of the individual or if the personnel ceases to work for the contractor and is no longer an employee of the contractor. The contractor shall not replace any of the key personnel without the written consent of the Engineer-in-charge. In case Contractor engages in such activity i.e. replacement of key personnel with or without EICs consent, such action shall attract a deduction of 10% of the total amount from the running account bill. However, there shall be no deduction if the replacement is made on health grounds of the personnel. The contractor shall submit medical certificate of such personnel intended to be replaced on health grounds.

6.13 Labour laws

The Contractor shall also comply with the provisions of all Acts, Laws, any Regulation or Bye Laws of any Local or other Statutory Authority applicable in relation to the execution of works such as:

- i) Payment of Wages Act, 1936 (Amended)
- ii) Minimum Wages Act, 1948 (Amended).
- iii) The Contract Labour (Regulation & Abolition) Act, 1970 with Rules framed there under as amended.
- iv) Workmen Compensation Act, 1923 as amended by Amendment Act no.65 of 1976.
- v) Employer's Liability Act 1938 (Amended)
- vi) Maternity Benefit Act. 1961 (Amended)
- vii) The Industrial Employment (Standing orders) Act 1946 (Amended).
- viii) The Industrial Disputes Act. 1947 (Amended)
- ix) Payment of Bonus Act.1965 and Amended Act No. 43 of 1977 and No. 48 of 1978 and any amended thereof:

-
- x) The Personal Injuries (Compensation Insurance) Act 1963 and any modifications thereof and rules made thereunder from time to time. The Contractor shall take into account all the above and financial liabilities in his quoted rates and nothing extra, whatsoever, shall be payable to him on this account.

The list is indicative only, otherwise the contractor should be aware of all the Acts/Labour Laws and should follow diligently on the work. The contractor shall be fully and personally responsible for the violation of any Act/Labour Law. Notwithstanding any other provision contained herein, the Contractor shall keep the Employer informed at all times, against all claims/actions that may arise under any applicable labour laws in relation to any labour/staff employed/hired by the contractor and /or its Sub contractor, for the execution of works awarded to the Contractor pursuant to this Contract.

7 Materials, Plant and Workmanship

7.1 Quality of Materials, Plant and Workmanship

All materials, Plant and workmanship shall be:

- (a) of the respective kinds described in the Contract and in accordance with the Engineer's instructions, and
- (b) subjected from time to time to such tests as the Engineer may require at the place of manufacture, fabrication or preparation, or on the Site or at such other place or places as may be specified in the Contract, or at all or any of such places.

The Contractor shall provide such assistance, labour, electricity, fuels, stores, apparatus and instruments as are normally required for examining, measuring and testing any materials or Plant and shall supply samples of materials, before incorporation in the Works, for testing as may be selected and required by the Engineer.

The Contractor is encouraged, to the extent practicable and reasonable, to use materials, Contractor's Equipment, Plant, and supplies from sources within the country of the Employer and the country where Works are executed.

7.2 Cost of Samples

All samples shall be supplied by the Contractor at his own cost if the supply thereof is clearly intended by or provided for in the Contract.

7.3 **Cost of Tests**

The cost of making any test shall be borne by the Contractor if such test is:

- (a) clearly intended by or provided for in the Contract, or
- (b) particularised in the Contract (in cases of a test under load or of a test to ascertain whether the design of any finished or partially finished work is appropriate for the purposes which it was intended to fulfil) in sufficient detail to enable the Contractor to price or allow for the same in his Tender.

7.4 **Cost of Tests not provided for**

If any test required by the Engineer which is:

- (a) not provided for,
- (b) (in the cases above mentioned) not so particularised, or
- (c) (though so intended or provided for) required by the Engineer to be carried out at any place other than the Site or the place of manufacture, fabrication or preparation of the materials or Plant tested, shows the materials, Plant or workmanship not to be in accordance with the provisions of the Contract to the satisfaction of the Engineer, then the cost of such test shall be borne by the Contractor, but in any other case Sub-Clause 7.5 shall apply.

7.5 **Engineer's Determination where Tests not provided for**

Where, pursuant to Sub-Clause 7.4, this Sub-Clause applies, the Engineer shall, after due consultation with the Contractor, determine any extension of time to which the Contractor is entitled under sub clause 8.6,8.7 and 8.8 of clause 8.

7.6 **Inspection of Operations**

The Engineer, and any person authorised by him, shall at all reasonable times have access to the Site and to all workshops and places where materials or Plant are being manufactured, fabricated or prepared for the Works and the Contractor shall afford every facility for and every assistance in obtaining the right to such access.

7.7 **Inspection and Testing**

The Engineer shall be entitled, during manufacture, fabrication or preparation to inspect and test the materials and Plant to be supplied under the Contract. If materials or Plant are being manufactured, fabricated or prepared in workshops or places other than those of the Contractor, the Contractor shall obtain permission for the Engineer to carry out such inspection and testing in those workshops or places. Such inspection or testing shall not release the Contractor from any obligation under the Contract.

7.8 Dates for Inspection and Testing

The Contractor shall agree with the Engineer on the time and place for the inspection or testing of any materials or Plant as provided in the Contract. The Engineer shall give the Contractor not less than 24 hours' notice of his intention to carry out the inspection or to attend the tests. If the Engineer, or his duly authorised representative, does not attend on the date agreed, the Contractor may, unless otherwise instructed by the Engineer, proceed with the tests and forthwith forward to the Engineer duly certified copies of the test readings. The Engineer will at the earliest but not later than 7 days from the date of receipt of such test-report, carryout scrutiny of the test readings and communicate to Contractor his concurrence to same or objections with reasons and instruction on further steps to be taken. If no communication is made by the Engineer within 7 days, the test shall be deemed to have been made in the presence of the Engineer.

7.9 Rejection

If, at the time and place agreed in accordance with Sub-Clause 7.8, the materials or Plant are not ready for inspection or testing or if, as a result of the inspection testing referred to in this Clause, the Engineer determines that the materials or Plant are defective or otherwise not in accordance with the Contract, he may reject the materials or Plant and shall notify the Contractor thereof immediately. The notice shall state the Engineer's objections with reasons. The Contractor shall then promptly make good the defect or ensure that rejected materials or Plant comply with the Contract. If the Engineer so requests, the tests of rejected materials or Plant shall be made or repeated under the same terms and conditions. All costs incurred by the Engineer by the repetition of the tests shall, after due consultation with the employer, be determined by the Engineer and shall be recoverable from the Contractor by the Employer and may be deducted from any monies due or to become due to the

Contractor and the Engineer shall notify the Contractor accordingly, with a copy to the employer.

7.10 Independent Inspection

The Engineer may delegate inspection and testing of materials, Works or Plant to an independent inspector or inspecting agency of specialised competence, experience or accreditation in carrying out such inspection. Any such delegation shall be effected in accordance with Sub-Clause 3.4 and for this purpose such independent inspector shall be considered as an assistant of the Engineer.

7.11 Examination of Work before Covering up

No part of the Works shall be covered up or put out of view without the approval of the Engineer and the Contractor shall afford full opportunity for the Engineer to examine and measure any such part of the Works which is about to be covered up or put out of view and to examine foundations before any part of the Works is placed thereon. The Contractor shall give notice to the Engineer whenever any such part of the Works or foundations is or are ready or about to be ready for examination and the Engineer shall, without unreasonable delay, unless he considers it unnecessary and advises the Contractor accordingly, attend for the purpose of examining and measuring such part of the Works or of examining such foundations.

7.12 Uncovering and Making Openings

The Contractor shall uncover any part of the Works or make openings in or through the same as the Engineer may from time to time instruct and shall reinstate and make good such part. If any such part has been covered up or put out of view after compliance with the requirement of Sub-Clause 7.11 and is found to be executed in accordance with the Contract, the Engineer shall, after due consultation with the Employer and the Contractor, determine the amount of the Contractor's costs in respect of such of uncovering, making openings in or through, reinstating and making good the same, which shall be added to the Contract Price, and shall notify the Contractor accordingly, with a copy to the Employer. In any other case all costs shall be borne by the Contractor.

7.13 Removal of Improper Work, Materials or Plant

The Engineer shall have authority to issue instructions from time to time, for:

-
- (a) the removal from the Site, within such time or times as may be specified in the instruction, of any materials or Plant which, in the opinion of the Engineer, are not in accordance with the Contract,
 - (b) the substitution of proper and suitable materials or Plant, and
 - (c) the removal and proper re-execution, notwithstanding any previous test thereof or interim payment therefor, of any work which, in respect of
 - (i) materials, Plant or workmanship, or
 - (ii) executed, installed by the Contractor or for which he is responsible, is not, in the opinion of the Engineer, in accordance with the Contract.

7.14 Default of Contractor in Compliance

In case of default on the part of the Contractor in carrying out such instruction within the time specified therein or, if none, within a reasonable time, the Employer shall be entitled to employ and pay other persons to carry out the same and all costs consequent thereon or incidental thereto shall, after due consultation with the Employer and the Contractor, be determined by the Engineer and shall be recoverable from the Contractor by the Employer, and may be deducted by the Employer from any monies due or to become due to the Contractor and the Engineer shall notify the Contractor accordingly, with a copy to the Employer.

8 Commencement, delays and suspensions

8.1 Commencement of Works

The Contractor shall commence the Works as soon as is reasonably possible after the receipt of the Letter of Award. Thereafter, the Contractor shall proceed with the Works with due expedition and without delay

8.2 Possession of Site and Access Thereto

As the Contract may prescribe:

- (a) the extent of portions of the Site of which the Contractor is to be given possession
- (b) the order in which such portions shall be made available to the Contractor, and, subject to any requirement in the Contract as to the order in which the

Works shall be executed, the Employer will, with the Engineer's notice to commence the Works, give to the Contractor possession of

- (c) so much of the Site, and
- (d) such access as, in accordance with the Contract, is to be provided by the Employer as may be required to enable the Contractor to commence and proceed with the execution of the Works in accordance with the programme referred to in Clause 4.9, if any, and otherwise in accordance with such reasonable proposals as the Contractor shall, by notice to the Engineer with a copy to the Employer, make. The Employer will, from time to time as the Works proceed, give to the Contractor possession of such further portions of the Site as may be required to enable the Contractor to proceed with the execution of the Works with due dispatch in accordance with such programme or proposals, as the case may be.

8.3 Failure to Give Possession

If the Contractor suffers delay and / or incurs costs from failure on the part of the Employer to give possession and access in accordance with the terms of Sub-Clause 8.2, the Engineer shall, after due consultation with the Employer and the Contractor, determine:

- (a) any extension of time to which the Contractor is entitled under sub clause 8.6, 8.7 and 8.8 of clause 8,

8.4 Rights of Way and Facilities

The Contractor shall bear all costs and charges for special or temporary rights of way required by him in connection with access to the Site. The Contractor shall also provide at his own cost any additional facilities outside the Site required by him for the purposes of the Works

8.5 Time for Completion

The Contractor agrees that Time is of essence. The whole of the Works and, if applicable, any Section required to be completed within a particular time as stated in the SCC, shall be completed in accordance with the provisions of Clause 10, calculated from the Commencement Date, or such extended time as may be allowed under sub clause 8.6, 8.7 and 8.8 of clause 8.

8.6 Extension of Time for Completion

In the event of:

- (a) the amount or nature of extra or additional work,
- (b) any cause of delay referred to in these Conditions,
- (c) exceptionally adverse climatic conditions,
- (d) any delay, impediment or prevention by the Employer, or
- (e) other special circumstances which may occur, other than through a default of or breach of contract by the Contractor or for which he is responsible,

being such as fairly to entitle the Contractor to an extension of the Time for Completion of the Works, or any Section or part thereof, the Engineer shall, after due consultation with the Employer and the Contractor, determine the amount of such extension and shall notify the Contractor accordingly, with a copy to the Employer.

8.7 Contractor to Provide Notification and Detailed Particulars

Provided that the Engineer is not bound to make any determination unless the Contractor has

- (a) within 28 days after such event has first arisen notified the Engineer with a copy to the Employer, and
- (b) within 28 days, or such other reasonable time as may be agreed by the Engineer, after such notification submitted to the Engineer detailed particulars of any extension of time to which he may consider himself entitled in order that such submission may be investigated at the time.

8.8 Interim Determination of Extension

Provided also that where an event has a continuing effect such that it is not practicable for the Contractor to submit detailed particulars within the period of 28 days referred to in Sub-Clause 8.7 (b), he shall nevertheless be entitled to an extension of time provided that he has submitted to the Engineer interim particulars at intervals of not more than 28 days and final particulars within 28 days of the end of the effects resulting from the event. On receipt of such interim particulars, the Engineer shall, without undue delay, make an interim determination of extension of time and, on receipt of the final particulars, the Engineer shall review all the circumstances and

shall determine an overall extension of time in regard to the event. In both such cases the Engineer shall make his determination after due consultation with the Employer and the Contractor and shall notify the Contractor of the determination, with a copy to the Employer. No final review shall result in a decrease of any extension of time already determined by the Engineer.

8.9 Restriction on Working Hours

Subject to any provision to the contrary contained in the Contract, none of the Works shall, save as hereinafter provided, be carried on during the night or on locally recognised days of rest without the consent of the Engineer. Provided that the provisions of this Clause shall not be applicable in the case of any work which it is customary to carry out by multiple shifts.

8.10 Progress Reports

Unless otherwise stated, the contractor shall prepare and submit the monthly progress reports concerning to the contract in such a form as may be required by the EIC on behalf of authority. The first report shall cover the period up to the end of the first calendar month following the Commencement Date. Reports shall be submitted monthly thereafter, each within 7 days after the last day of the period to which it relates. Reporting shall continue until the Contractor has completed all work which is known to be outstanding at the completion date stated in the Completion certificate for the Works.

The submission, receipt or acceptance of such reports shall not prejudice the right of the owner under the contract, nor shall operate as a stopple against the owner merely by the reason of the fact that he has not taken notice of or objected to any information contained in such report.

Each report shall include:

- (a) charts and detailed descriptions of progress, including each stage of execution, Contractor's Documents, procurement, manufacture, delivery to Site, construction, erection, testing, commissioning and trial operation;
- (b) photographs showing the status of manufacture and of progress on the Site;

-
- (c) for the manufacture of each main item of Plant and Materials, the name of the manufacturer, manufacture location, percentage progress, and the actual or expected dates of:
 - (i) commencement of manufacture,
 - (ii) Contractor's inspections,
 - (iii) tests, and
 - (iv) shipment and arrival at the Site;
 - (d) the details of Contractor's Personnel and Equipment deployed during the report period;
 - (e) list of Variations, and notices given , if any , under Sub-Clauses related to Employer's Claims and Contractor's Claims;
 - (f) safety statistics, including details of any hazardous incidents and activities relating to environmental aspects and public relations; and
 - (g) comparisons of actual and planned progress, with details of any events or circumstances which may jeopardize the completion in accordance with the Contract, and the measures being (or to be) adopted to overcome delays.
 - (h) One month target to be taken up along with comments to catch up the slipped milestone/target.

8.11 Rate of Progress

If for any reason, which does not entitle the Contractor to an extension of time, the rate of progress of the Works or any Section is at any time, in the opinion of the Engineer, too slow to comply with the Time for Completion, the Engineer shall so notify the Contractor who shall thereupon take such steps as are necessary, subject to the consent of the Engineer, to expedite progress so as to comply with the Time for Completion. The Contractor shall not be entitled to any additional payment for taking such steps.

8.12 Liquidated Damages for Delay

8.12.1 Liquidated Damages for Delay

If the Contractor fails to comply with the Time for Completion in accordance with Clause 4.3 Part I of ToR, for the whole of the Works or, if applicable, any Section within the relevant time prescribed by Clause 8.5, then the Contractor shall pay to the Employer the relevant sum stated below in the tabular form as liquidated damages for such default and not as a penalty (which sum shall be the only monies due from the Contractor for such default). The Employer may, without prejudice to any other method of recovery, withheld / deduct the amount of such damages from any monies due or to become due to the Contractor. The amount withheld or deduction against such damages shall not relieve the Contractor from his obligation to complete the Works, or from any other of his obligations and liabilities under the Contract.

Activity/ Stage	Time (in months from the date of signing of agreement)	%age of Contract value	% age LD applicable
Submission of preliminary design and methodology for all the activities for comments from EIC	T+ 30 days	10%	0.25% /week of the stage payment due
Completion of Fabrication of concrete Pontoons	T + 110 days	60%	1%/week of the stage payment
Installation of pontoon along with all accessories, gangways * (successful launching)	T+ 140 days	20%	0.5%/week of the stage payment due
Testing, commissioning handing over of concrete pontoons for providing floating terminal facilities and gangway.	T+ 150 days	10%	0.25% /week of the stage payment due
defect liability period	12 months after final delivery and taking over		

*** Total maximum LD shall be restricted to 10% of the contract value.**

If the contractor does not achieve a particular milestone as referred in clause 8.12.1 of detailed scope of work, or the re-scheduled milestone(s) in terms of Clause 8.6, 8.7 and 8.8, the amount as stipulated above, against that milestone shall be withheld.

With-holding of this amount on failure to achieve a milestone, shall be automatic without any notice to the contractor. However, if the contractor catches up with the progress of work on the subsequent milestone(s), the withheld amount shall be released. In case the contractor fails to make up for the delay in subsequent milestone(s), amount as stipulated in the table above, against each milestone missed subsequently shall also be withheld. However, no interest, whatsoever, shall be payable on such withheld amount. Permanent deduction of LD shall be as per clause 8.13

8.13 Permanent deduction of Liquidated Damages

In case the contractor does not complete the work in time, extension of time shall be given to the contractor to complete the work. It shall be at sole discretion of the EIC, who shall take all causes of delay into account, to provide extension of time withholding the liquidated damages accrued till the completion of commissioning of pontoons, gangway and gangways. The EIC may even exclude the period for application of liquidated damages in case he finds the causes of delay were attributable to employer or to other reasons for which the contractor cannot be held accountable. However, after setting aside such delays, LD accrual, balance LD accrual would be finally deducted from the final bill, as recommended by EIC. Total maximum LD shall be restricted to 10% of the contract value for respective schedules.

8.14 Suspension of Work

The Contractor shall, on the instructions of the Employer communicated by the Engineer suspend the progress of the Works or any part thereof for such time or times and in such manner as the Engineer may consider necessary and shall, during such suspension, properly protect and secure the Works or such part thereof so far as is necessary in the opinion of the Engineer. Unless such suspension is:

- (a) Otherwise provided for in the Contract,
- (b) Necessary by reason of some default of or breach of contract by the Contractor or for which he is responsible,
- (c) necessary by reason of climatic conditions on the Site, or
- (d) necessary for the proper execution of the Works or for the safety of the Works or any part thereof (save to the extent that such necessity arises from any act or default by the Engineer or the Employer or from any of the risks defined in Sub-Clause 2.2), Sub-Clause 8.15 shall apply.

8.15 Engineer's Determination following Suspension,

Where, pursuant to Sub-Clause 8.14, this Sub-Clause applies the Engineer shall after due consultation with the Employer and the Contractor, determine

- (a) any extension of time to which the Contractor is entitled under sub clause 8.6, 8.7 and 8.8 of clause 8, and
- (b) the amount, if any, which shall be added to the Contract Price, in respect of the cost incurred by the Contractor by reason of such suspension, and shall notify the Contractor accordingly, with a copy to the Employer.

8.16 Suspension lasting more than 84 Days

If the progress of the Works or any part thereof is suspended on the instructions of the Engineer and if permission to resume work is not given by the Engineer within a period of 84 days from the date of suspension then, unless such suspension is within paragraph (a), (b), (c) or (d) of Sub-Clause 8.14, the Contractor may give notice to the Engineer requiring permission, within 28 days from the receipt thereof, to proceed with the Works or that part thereof in regard to which progress is suspended. If, within the said time, such permission is not granted, the Contractor may, but is not bound to, elect to treat the suspension, where it affects part only of the Works, as an omission of such part under Clause 12.1 and 12.2 by giving a further notice to the Engineer to that effect, or, where it affects the whole of the Works, treat the suspension as an event of default by the Employer and terminate his employment under the Contract in accordance with the provisions of Sub-Clause 17.1, whereupon the provisions of Sub-Clauses 17.2 and 17.3 shall apply.

9 Tests On Completion

9.1 Contractors obligation

Contractor shall carry out all tests as per requirement of this contract. No additional charges on any such account shall be payable by the Employer.

The Contractor shall give to the Engineer not less than 21 days' notice of the date after which the Contractor will be ready to carry out each of the Tests on completion.
Unless

otherwise agreed, Tests on completion shall be carried out within 14 days after this date, on such day or days as the Engineer shall instruct.

In considering the results of the Tests on Completion, the Engineer shall make allowances for the effect of any use of the Works by the Employer on the performance or other characteristics of the Works. As soon as the Works, or a Section, have passed any Tests on Completion, the Contractor shall submit a certified report of the results of these Tests to the Engineer.

9.2 **Delayed Test**

If the Contractor is prevented, for more than 14 days, from carrying out the survey on Completion by a cause for which the Employer is responsible, the Employer shall be deemed to have taken over the Works on the date when the survey on Completion would otherwise have been completed.

If the Contractor suffers delay and/or incurs Cost as a result of this delay in carrying out the survey on Completion, the Contractor shall give notice to EMPLOYER / ENGINEER and shall be entitled.

- (a) an extension of time for any such delay, if completion is or will be delayed, and
- (b) Payment of any such Cost plus reasonable profit, which shall be additional to the Contract Price.

After receiving this notice, ENGINEER / EMPLOYER shall proceed to agree or determine these matters.

9.3 **Retesting**

If the Works, or a Section, fail to pass the Tests on Completion, the Contractor may require the failed Tests, and Tests of Completion on any related work, to be repeated under the same terms and conditions.

9.4 **Failure to Remedy Defects**

If the Contractor fails to remedy any damage within a reasonable time, a date may be fixed by (or on behalf of) the Employer, on or by which the damage is to be remedied. The Contractor shall be given reasonable notice of this date.

If the Contractor fails to remedy the damage by this notified date and this Remedial work was to be executed at the cost of the Contractor.

(a) carry out the work himself or by others, in a reasonable manner and at the Contractor's cost, but the Contractor shall have no responsibility for this work; and the Contractor shall pay to the Employer the costs reasonably incurred by the Employer in remedying the damage;

(b) Require ENGINEER / EMPLOYER to agree or determine a reasonable reduction in the Contract Price.

10 Employer's Taking over

10.1 Completion Certificate

When the whole of the Works have been substantially completed and have satisfactorily passed any Tests on Completion prescribed by the Contract, the Contractor may give a notice to that effect to the Engineer, with a copy to the Employer, accompanied by a written undertaking to finish with due expedition any outstanding work during the maintenance period. Such notice and undertaking shall be deemed to be a request by the Contractor for the Engineer to issue a Completion certificate in respect of the Works. The Engineer shall, within 21 days of the date of delivery of such notice, either issue to the Contractor, with a copy to the Employer, a completion Certificate, stating the date on which, in his opinion, the Works were substantially completed in accordance with the Contract, or give instructions in writing to the Contractor specifying all the work which, in the Engineer's opinion, is required to be done by the Contractor before the issue of such Certificate. The Engineer shall also notify the Contractor of any defects in the Works affecting substantial completion that may appear after such instructions and before completion of the Works specified therein. The Contractor shall be entitled to receive such Completion certificate within 21 days of completion, to the satisfaction of the Engineer, of the Works so specified and remedying any defects so notified.

10.2 Taking Over of Sections or Parts

Similarly, in accordance with the procedure set out in Sub-Clause 10.1, the Contractor may request and the Engineer shall issue a Completion certificate in respect of:

- (a) any Section in respect of which a separate Time for Completion is provided in the SCC,

-
- (b) any substantial part of the Permanent Works which has been both completed to the satisfaction of the Engineer and, otherwise than as provided for in the Contract, occupied or used by the Employer, or
 - (c) any part of the Permanent Works which the Employer has elected to occupy or use prior to completion (where such prior occupation or use is not provided for in the Contract or has not been agreed by the Contractor as a temporary measure).
 - (d) Punch list of the rectifications to be issued by the Engineer to the contractor.

10.3 Substantial Completion of Parts

If any part of the Permanent Works has been substantially completed and has satisfactorily passed any Tests on Completion prescribed by the Contract, the Engineer may issue a Completion certificate in respect of that part of the Permanent Works before completion of the whole of the Works and, upon the issue of such Certificate, the Contractor shall be deemed to have undertaken to complete with due expedition any outstanding work in that part of the Permanent Works during the maintenance period.

10.4 Approval only by Final Completion Certificate

Only the Final Completion Certificate, referred to in clause 10.5 and 10.6, shall be deemed to constitute final approval of works.

10.5 Final Completion Certificate

The Contract shall not be considered as completed until a Final Completion Certificate shall have been signed by the Engineer and delivered to the Employer, with a copy to, the Contractor, stating the date on which the Contractor shall have completed his obligations to execute and complete the Works and remedy any defects therein to the Engineer's satisfaction. The Final Completion Certificate shall be given by the Engineer within 28 days after the expiration of the Work Period.

10.6 Unfulfilled Obligations

Notwithstanding the issue of the Final Completion Certificate the Contractor and the Employer shall remain liable for the fulfilment of any obligation incurred under the provisions of the Contract prior to the issue of the Final Completion Certificate which

remains unperformed at the time such Final Completion Certificate is issued and, for the purposes of determining the nature and extent of any such obligation, the Contract shall be deemed to remain in force between the parties to the Contract.

11 Defects Liability

11.1 Defects Liability Period

In these Conditions the expression "Defects Liability Period" shall mean the defects liability period named in the SCC, calculated from:

- (a) the date of completion of the Works certified by the Engineer in accordance with Clause 10, or
 - (b) in the event of more than one certificate having been issued by the Engineer under Clause 10, the respective dates so certified,
- and in relation to the Defects Liability Period the expression "the Works" shall be construed accordingly.

11.2 Completion of Outstanding Work and Remedying Defects

To the intent that the Works shall, at or as soon as practicable after the expiration of the Defects Liability Period, be delivered to the Employer in the condition required by the Contract, fair wear and tear excepted, to the satisfaction of the Engineer, the Contractor shall:

- (a) Complete the work, if any, outstanding on the date stated in the Taking Over Certificate as soon as practicable after such date, and
- (b) execute all such work of amendment, reconstruction, and remedying defects, shrinkages or other faults as the Engineer may, during the Defects Liability Period or within 14 days after its expiration, as a result of an inspection made by or on behalf of the Engineer prior to its expiration, instruct the Contractor to execute.

11.3 Cost of Remedying Defects

All work referred to in Sub-Clause 10.2 (b) shall be executed by the Contractor at his own cost if the necessity thereof is, in the opinion of the Engineer, due to:

- (a) the use of materials, Plant or workmanship not in accordance with the Contract,
- (b) where the Contractor is responsible for the design of part of the Permanent works, any fault in such design, or

-
- (c) the neglect or failure on the part of the Contractor to comply with any obligation, expressed or implied, on the Contractor's part under the Contract.

If, in the opinion of the Engineer, such necessity is due to any other cause, he shall determine an addition to the Contract Price in accordance with Clause 13.3,13.4 & 13.5 and shall notify the Contractor accordingly, with a copy to the Employer.

11.4 Contractor's Failure to Carry Out Instructions

In case of default on the part of the Contractor in carrying out such instruction within a reasonable time, the Employer shall be entitled to employ and pay other persons to carry out the same and if such work is work which, in the opinion of the Engineer, the Contractor was liable to do at his own cost under the Contract, then all costs consequent thereon or incidental thereto shall, after due consultation with the Employer and the Contractor, be determined by the Engineer and shall be recoverable from the Contractor by the Employer, and may be deducted by the Employer from any monies due or to become due to the Contractor and the Engineer shall notify the Contractor accordingly, with a copy to the Employer.

11.5 Contractor to Search

If any defect, shrinkage or other fault in the Works appears at any time prior to the end of the Defects Liability Period, the Engineer may instruct the Contractor, with copy to the Employer, to search under the directions of the Engineer for the cause thereof. Unless such defect, shrinkage or other fault is one for which the Contractor is liable under the Contract, the Engineer shall, after due consultation with the Employer and the Contractor, determine the amount in respect of the costs of such search incurred by the Contractor, which shall be added to the Contract Price and shall notify the Contractor accordingly, with a copy to the Employer. If such defect, shrinkage or other fault is one for which the Contractor is liable, the cost of the work carried out in searching as aforesaid shall be borne by the Contractor and he shall in such case remedy such defect, shrinkage or other fault at his own cost in accordance with the provisions of Clause 11.

11.6 Approval only by Defects Liability Certificate

Only the Defects Liability certificate, referred to in clause 11.7 and 11.8, shall be deemed to constitute final approval of works.

11.7 Defects Liability Certificate

The Contract shall not be considered as completed until a Defects Liability Certificate shall have been signed by the Engineer and delivered to the Employer, with a copy to, the Contractor, stating the date on which the Contractor shall have completed his obligations to execute and complete the Works and remedy any defects therein to the Engineer's satisfaction. The Defects Liability Certificate shall be given by the Engineer within 28 days after the expiration of the Defects Liability Period, or, if different defects liability periods shall become applicable to different Sections or parts of the Permanent Works, the expiration of the latest such period, or as soon thereafter as any works instructed, pursuant to Clauses 11.1 to 11.5, have been completed to the satisfaction of the Engineer. Provided that the issue of the Defects Liability Certificate shall not be a condition precedent to payment to the Contractor of the second portion of the Retention Money in accordance with the conditions set out in Sub-Clause 15.5.

11.8 Unfulfilled Obligations

Notwithstanding the issue of the Defects Liability Certificate the Contractor and the Employer shall remain liable for the fulfilment of any obligation incurred under the provisions of the Contract prior to the issue of the Defects Liability Certificate which remains unperformed at the time such Defects Liability Certificate is issued and, for the purposes of determining the nature and extent of any such obligation, the Contract shall be deemed to remain in force between the parties to the Contract.

12 Measurement & omissions

12.1 Quantities

The quantities set out in the Bill of Quantities are the estimated quantities for the Works, and they are not to be taken as the actual and correct quantities of the Works to be executed by the Contractor in fulfilment of his obligations under the Contract.

12.2 Work to be Measured

The Engineer, shall except as otherwise stated, ascertain and determine by measurement the value of the Works in accordance with the Contract and the Contractor shall be paid that value in accordance with Clause 14. The Engineer shall, when he requires any part of the Works to be measured, give reasonable notice to the Contractor's authorised agent, who shall:

-
- (a) forthwith attend or send a qualified representative to assist the Engineer in making such measurement, and
 - (b) supply all particulars required by the Engineer.

Should the Contractor not attend, or neglect or omit to send such representative, then the measurement made by the Engineer or approved by him shall be taken to be the correct measurement of such part of the Works. For the purpose of measuring such Permanent Works as are to be measured by records and drawings, the Engineer shall prepare records and drawings as the work proceeds and the Contractor, as and when called upon to do so in writing, shall, within 14 days, attend to examine and agree such records and drawings with the Engineer and shall sign the same when so agreed. If the Contractor does not attend to examine and agree such records and drawings, they shall be taken to be correct. If, after examination of such records and drawings, the Contractor does not agree the same or does not sign the same as agreed, they shall nevertheless be taken to be correct, unless the Contractor, within 14 days of such examination, lodges with the Engineer notice of the respects in which such records and drawings are claimed by him to be incorrect. On receipt of such notice, the Engineer shall review the records and drawings and either confirm or vary them.

12.3 **Method of Measurement**

The Works shall be measured net, notwithstanding any general or local custom, except where otherwise provided for in the Contract.

12.4 **Breakdown of Lump Sum Items**

For the purposes of statements submitted in accordance with Sub-Clause 16.1, the Contractor shall submit to the Engineer, within 21 days after the receipt of the Letter of Award, a breakdown for each of the lump sum items contained in the Tender. Such breakdowns shall be subject to the approval of the Engineer.

12.5 **Omissions**

Whenever the omission of any work forms part (or all) of a Variation, the value of which has not been agreed, if:

- (a) The Contractor will incur (or has incurred) cost which, if the work had not been omitted, would have been deemed to be covered by a sum forming part of the Accepted Contract Amount;

-
- (b) The omission of the work will result (or has resulted) in this sum not forming part of the Contract Price; and
 - (c) This cost is not deemed to be included in the evaluation of any substituted work; then the Contractor shall give notice to ENGINEER / EMPLOYER accordingly, with supporting particulars. Upon receiving this notice, ENGINEER / EMPLOYER shall to agree or determine this cost, which shall be included in the Contract Price.

13 Variations, adjustments and Additions

13.1 Variation

The Engineer shall make any variation of the form, quality or quantity of the Works or any part thereof that may, in his opinion, be necessary and for that purpose, or if for any other reason it shall, in his opinion, be appropriate, he shall have the authority to instruct the Contractor to do and the Contractor shall do any of the following:

- (a) increase or decrease the quantity of any work included in the Contract,
- (b) omit any such work (but not if the omitted work is to be carried out by the Employer or by another contractor),
- (c) change the character or quality or kind of any such work,
- (d) change the levels, lines, position and dimensions of any part of the Works,
- (e) execute additional work of any kind necessary for the completion of the Works, or
- (f) change any specified sequence or timing of construction of any part of the Works.

No such variation shall in any way vitiate or invalidate the Contract, but the effect, if any, of all such variations shall be valued in accordance with Clause 13.3, 13.4 and 13.5. Provided that where the issue of an instruction to vary the Works is necessitated by some default of or breach of contract by the Contractor or for which he is responsible, any additional cost attributable to such default shall be borne by the Contractor.

13.2 Instructions for Variations

The Contractor shall not make any such variation without an instruction of the Engineer.

13.3 Valuation of Variations

All variations referred to in Clause 13.1 & 13.2 and any additions to the Contract Price which are required to be determined in accordance with Clause 13.3, 13.4 and 13.5 (for the purposes of this Clause referred to as "varied work"), shall be valued at the rates and prices set out in the Contract if, in the opinion of the Engineer, the same shall be applicable. If the Contract contain any rates or prices applicable to the varied work, the rates and prices in the Contract shall be used as the basis for valuation so far as may be reasonable, failing which, after due consultation by the Engineer with the Employer and the Contractor, suitable rates or prices shall be agreed upon between the Engineer and the Contractor. In the event of disagreement the Engineer shall fix such rates or prices as are, in his opinion, appropriate and shall notify the Contractor accordingly, with a copy to the Employer. Until such time as rates or prices are agreed or fixed, the Engineer shall determine provisional rates or prices to enable on-account payments to be included in certificates issued in accordance with Clause 15.

13.4 Power of Engineer to Fix Rates

Provided that if the nature or amount of any varied work relative to the nature or amount of the whole of the Works or to any part thereof, is such that, in the opinion of the Engineer, the rate or price contained in the Contract for any item of the Works is, by reason of such varied work, rendered inappropriate or inapplicable, then, after due consultation by the Engineer with the Employer and the Contractor, a suitable rate or price shall be agreed upon between the Engineer and the Contractor. In the event of disagreement the Engineer shall fix such other rate or price as is, in his opinion, appropriate and shall notify the Contractor accordingly, with a copy to the Employer. Until such time as rates or prices are agreed or fixed, the Engineer shall determine provisional rates or prices to enable on-account payments to be included in certificates issued in accordance with Clause 15.

Provided also that no varied work instructed to be done by the Engineer pursuant to Clause 13.1 & 13.2 shall be valued under Sub-Clause 13.3 or under this Sub-Clause unless, within 14 days of the date of such instruction and, other than in the case of

omitted work, before the commencement of the varied work, notice shall have been given either:

- (a) by the Contractor to the Engineer of his intention to claim extra payment or a varied rate or price, or
- (b) by the Engineer to the Contractor of his intention to vary a rate or price/

13.5 Variations Exceeding 20 per cent

The unit rate quoted by the Contractor shall remain unchanged for the quantities varying upto +/-20%. If, on the issue of the Completion Certificate for the whole of the Works, it is found that as a result of,

- (a) all varied work valued under Sub-Clauses 13.3 and 13.4, and
- (b) all adjustments in the estimated quantities set out in the Bill of Quantities, excluding adjustments of price made under Clause 23,

but not from any other cause, there have been additions to or deductions from the Contract Price in excess of 20 per cent(subject to a maximum of 50%)at variance with the Contract Price, then and in such event, after due consultation by the Engineer with the Employer and the Contractor, certain amount shall be added or subtracted from the contract price. The Engineer shall notify the Contractor of any determination made under this Sub-Clause, with a copy to the Employer. Such sum shall be based only on the amount by which such additions or deductions shall be at variance in excess of 20 per cent with the Contract Price.

14 Force Majeure

14.1 No Liability for Force Majeure

The Contractor shall be under no liability whatsoever in consequence of any of the special risks referred to in Sub-Clause 14.2, whether by way of indemnity or otherwise, for or in respect of:

- (a) Destruction of or damage to the Works, save to work condemned under the provisions of Clause 7.13 and 7.14 prior to the occurrence of any of the said special risks,
- (b) Destruction of or damage to property, whether of the Employer or third parties, or

-
- (c) Injury or loss of life.

14.2 Force Majeure

The Force Majeure is:

- (a) the risks defined under paragraphs (a), (c), (d) and (e) of Sub-Clause 2.2, and
- (b) the risks defined under paragraph (b) of Sub-Clause 2.2 insofar as these relate to the country in which the Works are to be executed.

14.3 Damage to Works by Force Majeure

If the Works or any materials or Plant on or near or in transit to the Site, sustain destruction or damage by reason of any of the said special risks, the Contractor shall be entitled to payment in accordance with the Contract for any Permanent Works duly executed and for any materials or Plant so destroyed or damaged and, so far as may be required by the Engineer or as may be necessary for the completion of the Works, to payment for:

- (a) Rectifying any such destruction or damage to the Works, and
- (b) Replacing or rectifying such materials or plant, and the Engineer shall determine an addition to the Contract Price in accordance with Clause 13.3, 13.4 & 13.5 and shall notify the Contractor accordingly, with a copy to the Employer.

14.4 Projectile, Missile

Destruction, damage, injury or loss of life caused by the explosion or impact, whenever and wherever occurring, of any mine, bomb, shell, grenade, or other projectile, missile, munitions, or explosive of war, shall be deemed to be a consequence of the said special risks.

14.5 Increased Costs arising from Force Majeure

Save to the extent that the Contractor is entitled to payment under any other provision of the Contract, the Employer shall pay to the Contractor any costs of the execution of the Works (other than such as may be attributable to the cost of reconstructing work condemned under the provisions of Clause 7.13 & 7.14 prior to the occurrence of any special risk) which are howsoever attributable to or consequent on or the result of or in any way whatsoever connected with the said special risks, subject however to the

provisions in this Clause hereinafter contained in regard to outbreak of war, but the Contractor shall, as soon as any such cost comes to his knowledge, forthwith notify the Engineer thereof. The Engineer shall, after due consultation with the Employer and the Contractor, determine the amount of the Contractor's costs in respect thereof which shall be added to the Contract Price and shall notify the Contractor accordingly, with a copy to the Employer.

14.6 Outbreak of War

If, during the currency of the Contract, there is an outbreak of war, whether war is declared or not, in any part of the world which, whether financially or otherwise, materially affects the execution of the Works, the Contractor shall, unless and until the Contract is terminated under the provisions of this Clause, continue to use his best endeavours to complete the execution of the Works. Provided that the Employer shall be entitled, at any time after such outbreak of war, to terminate the Contract by giving notice to the Contractor and, upon such notice being given, the Contract shall, except as to the rights of the parties under this Clause and Clause 16.3, terminate, but without prejudice to the rights of either party in respect of any antecedent breach thereof.

14.7 Removal of Contractor's Equipment on Termination

If the Contract is terminated under the provisions of Sub-Clause 14.6, the Contractor shall, with all reasonable dispatch, remove from the Site all Contractor's Equipment and shall give similar facilities to his Subcontractors to do so.

14.8 Payment if Contract Terminated

If the Contract is terminated as aforesaid, the Contractor shall be paid by the Employer, insofar as such amounts or items have not already been covered by payments on account made to the Contractor, for all work executed prior to the date of termination at the rates and prices provided in the Contract and in addition:

- (a) The amounts payable in respect of any preliminary items referred to in the Bill of Quantities, so far as the work or service comprised therein has been carried out or performed, and a proper proportion of any such items which have been partially carried out or performed;
- (b) The cost of materials, Plant or goods reasonably ordered for the Works which have been delivered to the Contractor or of which the Contractor is legally

liable to accept delivery, such materials, Plant or goods becoming the property of the Employer upon such payments being made by him;

- (c) A sum being the amount of any expenditure reasonably incurred by the Contractor in the expectation of completing the whole of the Works insofar as such expenditure has not been covered by any other payments referred to in this Sub-Clause;
- (d) Any additional sum payable under the provisions of Sub-Clauses 14.3 and 14.5;
- (e) such proportion of the cost as may be reasonable, taking into account payments made or to be made for work executed, of removal of Contractor's Equipment under Sub-Clause 14.7 and, if required by the Contractor, return thereof to the Contractor's main plant yard in his country of registration or to other destination, at no greater cost; and
- (f) The reasonable cost of repatriation of all the Contractor's staff and workmen employed on or in connection with the Works at the time of such termination.

Provided that against any payment due from the Employer under this Sub-Clause, the Employer shall be entitled to be credited with any outstanding balances due from the Contractor for advances in respect of mobilization and any other sums which, at the date of termination, were recoverable by the Employer from the Contractor under the terms of the Contract. Any sums payable under this Sub-Clause shall, after due consultation with the Employer and the Contractor, be determined by the Engineer who shall notify the Contractor accordingly, with a copy to the Employer.

15 Certificates and Payment

15.1 Monthly Statements

The Contractor shall submit to the Engineer after the end of each month six copies, each signed by the Contractor's representative approved by the Engineer in accordance with Sub-Clause 4.10, of a statement, in such form as the Engineer may from time to time prescribe, showing the amounts expressed in Indian Rupees, to which the Contractor considers himself to be entitled up to the end of the month in respect of:

-
- (a) The value of the Works executed with reference to the contract
 - (b) Any other items in the Bill of Quantities.
 - (c) the percentage of the invoice value of listed materials, all as stated in the SCC, and Plant delivered by the Contractor on the Site for incorporation in the Permanent Works but not incorporated in such Works,
 - (d) Adjustments under Clause 23, and
 - (e) Any other sum to which the Contractor may be entitled under the Contract or otherwise.

15.2 Monthly Payments

The Engineer shall, within 28 days of receiving such statement, deliver to the Employer an Interim Payment Certificate stating the amount of payment to the Contractor which the Engineer considers due and payable in respect of such statement, subject:

- (a) firstly, to the retention of the amount calculated by applying the Percentage of Retention stated in the SCC, to the amount to which the Contractor is entitled under paragraphs (a), (b), (c) and (e) of Sub-Clause 15.1 until the amount so retained reaches the Limit of Retention Money stated in the SCC, and
- (b) secondly, to the deduction, other than pursuant to Clause 8.12 and 8.13, of any sums which may have become due and payable by the Contractor to the Employer.

Provided that the Engineer shall not be bound to certify any payment under this Sub-Clause if the net amount thereof, after all retentions and deductions, would be less than the Minimum Amount of Interim Payment Certificates stated in the SCC.

Notwithstanding the terms of this Clause or any other Clause of the Contract no amount will be certified by the Engineer for payment until the performance security, if required under the Contract, has been provided by the Contractor and approved by the Employer.

15.3 Place of Payment

Payments to the Contractor by the Employer shall be made in the currencies in which the Contract Price is payable into a bank account or accounts nominated by the Contractor in the country of the Employer.

15.4 **Retention Money**

A retention amounting to the percentage stipulated in the SCC shall be made by the Engineer in the first and following Interim Payment Certificates till the specified limit of Retention money as in SCC.

15.5 **Payment of Retention Money**

Upon the issue of the Completion certificate with respect to the whole of the Works, one half of the Retention Money, or upon the issue of a Completion certificate with respect to a Section or part of the Permanent Works only such proportion thereof as the Engineer determines having regard to the relative value of such Section or part of the Permanent Works, shall be certified by the Engineer for payment to the Contractor.

15.6 **Correction of Certificates**

The Engineer may by any Interim Payment Certificate make any correction or modification in any previous Interim Payment Certificate which shall have been issued by him and shall have authority, if any work is not being carried out to his satisfaction, to omit or reduce the value of such work in any Interim Payment Certificate.

15.7 **Statement at Completion**

Not later than 30 days after the issue of the Completion Certificate in respect of the whole of the Works, the Contractor shall submit to the Engineer six copies of Statement at Completion with supporting documents showing in detail, in the form approved by the Engineer:

- (a) the final value of all work done, in Indian Rupees, in accordance with the Contract up to the date stated in such completion Certificate,
- (b) any further sums which the Contractor considers to be due, and
- (c) an estimate of amounts which the Contractor considers will become due to him under the Contract.

The estimated amounts shall be shown separately in such Statement at Completion. The Engineer shall certify payment in accordance with Sub-Clause 15.2.

15.8 Final Statement

Not later than 30 days after the issue of the final completion certificate, the Contractor shall submit to the Engineer for consideration six copies of a draft final statement with supporting documents showing in detail, in the form approved by the Engineer:

- (a) the value of all work done in accordance with the Contract, and
- (b) any further sums which the Contractor considers to be due to him under the Contract or otherwise.

If the Engineer disagrees with or cannot verify any part of the draft final statement, the Contractor shall submit such further information as the Engineer may reasonably require and shall make such changes in the draft as may be agreed between them. The Contractor shall then prepare and submit to the Engineer the final statement as agreed (for the purposes of these Conditions referred to as the "Final Statement").

If, following discussions between the Engineer and the Contractor and any changes to the draft final statement which may be agreed between them, it becomes evident that a dispute exists, the Engineer shall deliver to the Employer an Interim Payment Certificate for those parts of the draft final statement, if any, which are not in dispute. The dispute may then be settled in accordance with Clause 16.3.

15.9 Discharge

Upon submission of the Final Statement, the Contractor shall give to the Employer, with a copy to the Engineer, a written discharge confirming that the total of the Final Statement represents full and final settlement of all monies due to the Contractor arising out of or in respect of the Contract. Provided that such discharge shall become effective only after payment due under the Final Payment Certificate issued pursuant to Sub-Clause 15.10 has been made and the performance security referred to in Sub-Clause 4.4, if any, has been returned to the Contractor.

15.10 Final Payment Certificate

Within 14 days after receipt of the Final Statement, and the written discharge, the Engineer shall issue to the Employer (with a copy to the Contractor) a Final Payment Certificate stating:

- (a) the amount which, in the opinion of the Engineer, is finally due under the Contract or otherwise, and
- (b) after giving credit to the Employer for all amounts previously paid by the Employer and for all sums to which the Employer is entitled other than under Clause 8.12 and 8.13, the balance, if any, due from the Employer to the Contractor or from the Contractor to the Employer as the case may be.

15.11 Cessation of Employer's Liability

The Employer shall not be liable to the Contractor for any matter or thing arising out of or in connection with the Contract or execution of the Works, unless the Contractor shall have included a claim in respect thereof in his Final Statement and (except in respect of matters or things arising after the issue of the Completion certificate in respect of the whole of the Works) in the Statement at Completion referred to in Sub-Clause 14.7.

15.12 Time for Payment

The amount due to the Contractor under any Interim Payment Certificate issued by the Engineer pursuant to this Clause, or to any other term of the Contract, shall, subject to Clause 8.12 and 8.13, be paid by the Employer to the Contractor within 28 days after such Interim Payment Certificate has been delivered to the Employer, or, in the case of the Final Payment Certificate referred to in Sub-Clause 15.8, within 30 days, after such Final Payment Certificate has been delivered to the Employer..

15.13 Advance Payment

The Contractor shall be eligible to receive an advance payment for an amount stated in the SCC. Payment of such advance amount will be due under certification by the Engineer after (a) execution of the Form of Agreement by the parties hereto; (b) provision by the Contractor of the performance security in accordance with Sub-Clause 4.4; and (c) provision by the Contractor of an unconditional bank guarantee for equal amount in a form and by a bank acceptable to the Employer. Such bank guarantee shall remain effective until the advance payment has been repaid pursuant

to the paragraph below, but the amount thereof shall be progressively reduced by the amount repaid by the Contractor as indicated in Interim Payment Certificates issued in accordance with this clause.

The advance payment shall be repaid through percentage deductions from the interim payments certified by the Engineer in accordance with this clause. Deductions shall commence in the next Interim Payment Certificate following that in which the total of all interim payments certified to the Contractor has reached the percentage of the Contract Price stipulated in the SCC less Provisional Sums, if any, and shall be made at the rate stated in the SCC of the amount of all Interim Payment Certificates until such time as the advance payment has been repaid; always provided that the advance payment shall be completely repaid prior to the time when 80 percent of the Contract Price has been certified for payment.

16 Claims, provisional sum and Settlement of disputes

16.1 Claims

16.1.1 Notice of Claims

Notwithstanding any other provision of the Contract, if the Contractor intends to claim any additional payment pursuant to any Clause of these Conditions or otherwise, he shall give notice of his intention to the Engineer, with a copy to the Employer, within 28 days after the event giving rise to the claim has first arisen.

16.1.2 Contemporary Records

Upon the happening of the event referred to in Sub-Clause 16.1.1, the Contractor shall keep such contemporary records as may reasonably be necessary to support any claim he may subsequently wish to make. Without necessarily admitting the Employer's liability, the Engineer shall, on receipt of a notice under Sub-Clause 16.1.1, inspect such contemporary records and may instruct the Contractor to keep any further contemporary records as are reasonable and may be material to the claim of which notice has been given. The Contractor shall permit the Engineer to inspect all records kept pursuant to this Sub-Clause and shall supply him with copies thereof as and when the Engineer so instructs.

16.1.3 Substantiation of Claims

Within 28 days, or such other reasonable time as may be agreed by the Engineer, of giving notice under Sub-Clause 16.1.1, the Contractor shall send to the Engineer an account giving detailed particulars of the amount claimed and the grounds upon which the claim is based. Where the event giving rise to the claim has a continuing effect, such account shall be considered to be an interim account and the Contractor shall, at such intervals as the Engineer may reasonably require, send further interim accounts giving the accumulated amount of the claim and any further grounds upon which it is based. In cases where interim accounts are sent to the Engineer, the Contractor shall send a final account within 28 days of the end of the effects resulting from the event. The Contractor shall, if required by the Engineer so to do, copy to the Employer all accounts sent to the Engineer pursuant to this Sub-Clause.

16.1.4 Failure to Comply

If the Contractor fails to comply with any of the provisions of this Clause in respect of any claim which he seeks to make, his entitlement to payment in respect thereof shall not exceed such amount as the Engineer or any arbitrator or arbitrators appointed pursuant to Sub-Clause 16.3.3 assessing the claim considers to be verified by contemporary records (whether or not such records were brought to the Engineer's notice as required under Sub-Clauses 16.1.2 and 16.1.3).

16.1.5 Payment of Claims

The Contractor shall be entitled to have included in any interim payment certified by the Engineer pursuant to Clause 14 such amount in respect of any claim as the Engineer, after due consultation with the Employer and the Contractor, may consider due to the Contractor provided that the Contractor has supplied sufficient particulars to enable the Engineer to determine the amount due. If such particulars are insufficient to substantiate the whole of the claim, the Contractor shall be entitled to payment in respect of such part of the claim as such particulars may substantiate to the satisfaction of the Engineer. The Engineer shall notify the Contractor of any determination made under this Sub-Clause, with a copy to the Employer.

16.2 Provisional Sums

16.2.1 Definition of "Provisional Sum"

“Provisional Sum” means a sum included in the Contract and so designated in the Bill of Quantities for the execution of any part of the Works or for the supply of goods, materials, Plant or services, or for contingencies, which sum may be used, in whole or in part, or not at all, on the instructions of the Engineer. The Contractor shall be entitled to only such amounts in respect of the work, supply or contingencies to which such Provisional Sums relate as the Engineer shall determine in accordance with this Clause. The Engineer shall notify the Contractor of any determination made under this Sub-Clause, with a copy to the Employer.

16.2.2 Use of Provisional Sums

In respect of every Provisional Sum the Engineer shall have authority to issue instructions for the execution of work or for the supply of goods, materials, Plant, Labour or services by:

- (a) the Contractor, in which case the Contractor shall be entitled to an amount equal to the value thereof determined in accordance with Clause 13.3, 13.4 and 13.5, and
- (b) a nominated Subcontractor, as hereinafter defined, in which case the sum to be paid to the Contractor therefor shall be determined and paid in accordance with Sub-Clause 5.4.4.

16.2.3 Production of Vouchers

The Contractor shall produce to the Engineer all quotations, invoices, vouchers and accounts or receipts in connection with expenditure in respect of Provisional Sums, except where work is valued in accordance with rates or prices set out in the Tender.

16.3 Settlement of Disputes

16.3.1 Engineer’s Decision

If a dispute of any kind whatsoever arises between the Employer and the Contractor in connection with, or arising out of, the Contract or the execution of the Works, whether during the execution of the Works or after their completion and whether before or after repudiation or expulsion or other termination of the Contract, including any dispute as to any opinion, instruction, determination, certificate or valuation of the Engineer, the matter in dispute shall, in the first place, be referred in writing to the Engineer, with a copy to the other party. Such reference shall state that it is made

pursuant to this Clause. No later than the 30th day after the day on which he received such reference the Engineer shall give notice of his decision to the Employer and the Contractor. Such decision shall state that it is made pursuant to this Clause.

Unless the Contract has already been repudiated or terminated, the Contractor shall, in every case, continue to proceed with the Works with all due diligence and the Contractor and the Employer shall give effect forthwith to every such decision of the Engineer unless and until the same shall be revised, as hereinafter provided, in an amicable settlement or an arbitral award.

If either the Employer or the Contractor be dissatisfied with any decision of the Engineer, or if the Engineer fails to give notice of his decision on or before the 30th day after the day on which he received the reference, then either the Employer or the Contractor may, on or before the seventieth day after the day on which he received notice of such decision, or on or before the seventieth day after the day on which the said period of 30 days expired, as the case may be, give notice to the other party, with a copy for information to the Engineer, of his intention to commence arbitration, as hereinafter provided, as to the matter in dispute. Such notice shall establish the entitlement of the party giving the same to commence arbitration, as hereinafter provided, as to such dispute and, subject to Sub-Clause 16.3.4, no arbitration in respect thereof may be commenced unless such notice is given.

If the Engineer has given notice of his decision as to a matter in dispute to the Employer and the Contractor and no notice of intention to commence arbitration as to such dispute has been given by either the Employer or the Contractor on or before the day specified here above, the said decision shall become final and binding upon the Employer and the Contractor.

16.3.2 Amicable Settlement

Where notice of intention to commence arbitration as to a dispute has been given in accordance with Sub-Clause 16.3.1, the parties shall attempt to settle such dispute amicably before the commencement of arbitration. Provided that, unless the parties otherwise agree, arbitration may be commenced on or after the 28th day after the day on which notice of intention to commence arbitration of such dispute was given, even if no attempt at amicable settlement thereof has been made.

16.3.3 Arbitration

Any dispute in respect of which:

- (a) the decision, if any, of the Engineer has not become final and binding pursuant to Sub-Clause 16.3.1, and
- (b) amicable settlement has not been reached within the period stated in Sub-Clause 16.3.2, shall be referred for arbitration in the manner provided as under and to the sole arbitrator appointed as follows:
 - (i) Either of the parties may give to the other notice in writing of the existence of such question of dispute or difference with a copy to the Engineer within the time specified in clause 16.3.1.
 - (ii) Within twenty eight (28) days of receipts of such notice from either party the Engineer in Consultation with the Employer shall send to the contractor a panel of three persons and the contractor within twenty one (21) days of receipt of such panel communicate to the Engineer and Employer the name of one of the persons from such panel and such person shall then be appointed a sole arbitrator by the Employer. However, the arbitrator so appointed shall not be an officer or the employee of the Employer or Engineer.
 - (iii) Provided that if the contractor fails to communicate the selection of a name out of the panel so forwarded to him within the specified time, Employer shall without delay select one person from the aforesaid panel and appoint him as the sole arbitrator.
 - (iv) The arbitrator to whom the matter is originally referred being transferred or vacating his office or being unable to act for any reason, then the Employer shall appoint another person to act as sole arbitrator, such person shall be entitled to proceed with the reference from the stage at which the predecessor left it.
 - (v) The award of the arbitrator shall be final and binding. The arbitrator shall decide in what proportion the arbitrator's fees, as well as the cost of Arbitration proceeding shall be borne equally by either party.
 - (vi) The arbitrator with the consent of the parties can enlarge the time, from time to time to make and publish his award.

-
- (vii) A notice of the existence in question dispute or difference in connection with the contract unless served by either party within 30 days after the issue of Final Completion Certificate, failing which all rights and claim under this contract shall be deemed to have been waived and thus forfeited and absolutely barred.
- (viii) The work under this contract shall continue during arbitration proceedings and no valid payments due from or payment by the Employer shall be withheld on account of such proceedings except to the extent, which may be in dispute.
- (ix) The Arbitration shall be conducted in accordance with the provisions of the Arbitration & Conciliation Act, 1996 read with the Arbitration & Conciliation (Amendment) Act, 2015 or any statutory modifications or re-enactment thereof and the rules made thereunder and for the time being in force shall apply to the arbitration proceeding under this clause.

The Arbitrator shall have the power to enlarge the term to rate the award with the consent of the parties provided always that the commencement or continuation of the arbitration proceeding shall not result in cessation or suspension of any of other rights and obligations of the parties of any payments due to them hereunder.

The venue of the arbitration proceedings shall be at Delhi/NCR. It is further clarified that both the parties to this agreement hereby undertake not to have recourse to civil court to solve any of their dispute whatsoever, arising out of this agreement except through arbitration.

In addition to this clause, in case of contract with another Public Sector Undertaking, following Arbitration Clause shall apply: "Except as otherwise provided, in case of a contract with a public Sector Undertaking if at any time any question dispute or difference whatsoever arises between the parties upon or in relation to, or in connection with this agreement, the same shall be settled in terms of the Ministry of Industry, Department of Public Enterprises O.M No. 3/5/93-PMA dt.30.06.93 or any modifications / amendments thereof. "The arbitrator shall have the power to enlarge the term to publish the award with the consent of the parties provided always that the commencement or continuation of the arbitration proceeding shall not result in

cessation or suspension of any of other rights and obligations of the parties of any payments due to them hereunder.

16.3.4 Laws governing the Contract

- i) The laws of India shall govern this contract.
- ii) Irrespective of the place of Works, the place of performance or place of payment under the contract, the contract shall be deemed to have been made at the place from which the Letter of Award has been issued.
- iii) Courts of the place from where the Letter of Award of tender has been issued shall alone have jurisdiction to decide any dispute arising out of or in respect of contract. Notwithstanding anything contained in this Agreement, Parties hereby submit to the exclusive jurisdiction of such court alone.

16.3.5 Failure to Comply with Engineer's Decision

Where neither the Employer nor the Contractor has given notice of intention to commence arbitration of a dispute within the period stated in Sub-Clause 16.3.1 and the related decision has become final and binding, either party may, if the other party fails to comply with such decision, and without prejudice to any other rights it may have, refer the failure to arbitration in accordance with Sub-Clause 16.3.2. The provisions of Sub-Clauses 16.3.1 and 16.3.2 shall not apply to any such reference.

17 Termination by the Employer

17.1 Default of Contractor

If the Contractor is deemed by law unable to pay his debts as they fall due, or enters into voluntary or involuntary bankruptcy, liquidation or dissolution (other than a voluntary liquidation for the purposes of amalgamation or reconstruction), or becomes insolvent, or makes an arrangement with, or assignment in favour of, his creditors, or agrees to carry out the Contract under a committee of inspection of his creditors, or if a receiver, administrator, trustee or liquidator is appointed over any substantial part of his assets, or if, under any law or regulation relating to reorganization, arrangement or readjustment of debts, proceedings are commenced against the Contractor or resolutions passed in connection with dissolution or liquidation or if any steps are taken to enforce any security interest over a substantial part of the assets of the Contractor, or if any act is done or event occurs with respect to the Contractor or his

assets which, under any applicable law has a substantially similar effect to any of the foregoing acts or events, or if the Contractor has contravened Sub-Clause 5.1, or has an execution levied on his goods, or if the Engineer certifies to the Employer, with a copy to the Contractor, that, in his opinion, the Contractor:

- (a) has repudiated the Contract,
- (b) without reasonable excuse has failed
 - (i) to commence the Works in accordance with Sub-Clause 8.1 or
 - (ii) to proceed with the Works, or any Section thereof, within 28 days after receiving notice pursuant to Sub-Clause 8.11,
- (c) has failed to comply with a notice issued pursuant to Sub-Clause 7.9 or an instruction issued pursuant to Sub-Clause 7.13 within 28 days after having received it,
- (d) despite previous warning from the Engineer, in writing, is otherwise persistently or flagrantly neglecting to comply with any of his obligations under the Contract, or
- (e) has contravened Sub-Clause 5.2,

then the Employer may, after giving 14 days' notice to the Contractor, enter upon the Site and expel the Contractor there from without thereby violating the Contract, or releasing the Contractor from any of his obligations or liabilities under the Contract, or affecting the rights and powers conferred on the Employer or the Engineer by the Contract, and may himself complete the Works or may employ any other contractor to complete the Works. The Employer or such other contractor may use for such completion so much of the Contractor's Equipment, Plant, Temporary Works, and materials, which have been deemed to be reserved exclusively for the execution of the Works, under the provisions of the Contract, as he or they may think proper, and the Employer may, at any time, sell any of the said Contractor's Equipment, Temporary Works, and unused Plant and materials, and apply the proceeds of sale in or toward the satisfaction of any sums due or that may become due to him from the Contractor under the Contract.

17.2 Valuation at Date of Expulsion

The Engineer shall, as soon as may be practicable after any such entry and expulsion by the Employer, fix and determine ex parte, or by or after reference to the parties or after such investigation or enquiries as he may think fit to make or institute, and shall certify:

- a) what amount (if any) had, at the time of such entry and expulsion, been reasonably earned by or would reasonably accrue to the Contractor in respect of work then actually done by him under the Contract, and
- (b) the value of any of the said unused or partially used materials, any Contractor's Equipment and any Temporary Works.

17.3 **Payment after Expulsion**

If the Employer shall enter and expel the Contractor under this Clause, the Earnest Money Deposit, Security Deposit already recovered and Performance Guarantee under the contract shall be liable to be forfeited and shall be absolutely at the disposal of the IWAI. Further, the Employer shall enter and expel the Contractor under this Clause, he shall not be liable to pay to the Contractor any further amount (including damages) in respect of the Contract until the expiration of the Maintenance Period and thereafter until the costs of execution, completion and remedying of any defects, damages for delay in completion (if any) and all other expenses incurred by the Employer have been ascertained and the amount thereof certified by the Engineer. The Contractor shall then be entitled to receive only such sum (if any) as the Engineer may certify would have been payable to him upon due completion by him after deducting the said amount. If such amount exceeds the sum which would have been payable to the Contractor on due completion by him, then the Contractor shall, upon demand, pay to the Employer the amount of such excess and it shall be deemed a debt due by the Contractor to the Employer and shall be recoverable accordingly.

17.4 **Assignment of Benefit of Agreement**

Unless prohibited by law, the Contractor shall, if so instructed by the Engineer within 14 days of such entry and expulsion referred to in Sub-Clause 17.1, assign to the Employer the benefit of any agreement for the supply of any goods materials or services and/or for the execution of any work for the purposes of the Contract, which the Contractor may have entered into.

17.5 **Corrupt or Fraudulent Practices**

If in the judgment of the Employer the Contractor has engaged in corrupt or fraudulent practices, in competing for or in executing the Contract, then the Employer may, after having given 14 days' notice to the Contractor, terminate the Contractor's employment under the Contract and expel him from the Site, and the provisions of Clause 16 shall apply as if such expulsion had been made under Sub-Clause 17.1.

"Corrupt practice" means the offering, giving, receiving, or soliciting of anything of value to influence the action of a public official, Employer, Engineer or their representatives in the procurement process or in Contract execution.

"Fraudulent practice" means a misrepresentation of facts in order to influence a procurement process or the execution of a Contract to the detriment of the Borrower, and includes collusive practice among bidders (prior to or after bid submission) designed to establish bid prices at artificial non-competitive levels and to deprive the Borrower of the benefits of free and open competition.

17.6 **Urgent Remedial Work**

If, by reason of any accident, or failure, or other event occurring to, in, or in connection with the Works, or any part thereof, either during the execution of the Works, or during the Maintenance Period, any remedial or other work is, in the opinion of the Engineer, urgently necessary for the safety of the Works and the Contractor is unable or unwilling at once to do such work, the Employer shall be entitled to employ and pay other persons to carry out such work as the Engineer may consider necessary. If the work or repair so done by the Employer is work which, in the opinion of the Engineer, the Contractor was liable to do at his own cost under the Contract, then all costs consequent thereon or incidental thereto shall, after due consultation with the Employer and the Contractor, be determined by the Engineer and shall be recoverable from the Contractor by the Employer, and may be deducted by the Employer from any monies due or to become due to the Contractor and the Engineer shall notify the Contractor accordingly, with a copy to the Employer. Provided that the Engineer shall, as soon after the occurrence of any such emergency as may be reasonably practicable, notify the Contractor thereof.

18 **Termination by Contractor**

18.1 Default of Employer

In the event of the Employer:

- (a) Failing to pay to the Contractor the amount due under any certificate of the Engineer within 28 days after the expiry of the time stated in Sub-Clause 15.12, within which payment is to be made, subject to any deduction that the Employer is entitled to make under the Contract,
- (b) Interfering with or obstructing or refusing any required approval to the issue of any such certificate,
- (c) becoming bankrupt or, being a company, going into liquidation, other than for the purpose of a scheme of reconstruction or amalgamation, or
- (d) giving notice to the Contractor that for unforeseen economic reasons it is impossible for him to continue to meet his contractual obligations, the Contractor shall be entitled to terminate his employment under the Contract by giving notice to the Employer, with a copy to the Engineer. Such termination shall take effect 14 days after the giving of the notice.

18.2 Removal of Contractor's Equipment

Upon the expiry of the 14 days' notice referred to in Sub-Clause 17.1, the Contractor shall, notwithstanding the provisions of Sub-Clause 4.36.1, with all reasonable despatch, remove from the Site all Contractor's Equipment brought by him thereon.

18.3 Payment on Termination

In the event of such termination, the Employer shall be under the same obligations to the Contractor in regard to payment as if the Contract had been terminated under the provisions of Clause 14.

18.4 Contractor's Entitlement to Suspend Work

Without prejudice to the Contractor's entitlement to interest under Sub-Clause 15.12 and to terminate under Sub-Clause 17.1, the Contractor may, if the Employer fails to pay the Contractor the amount due under any certificate of the Engineer within 28 days after the expiry of the time stated in Sub-Clause 15.12 within which payment is to be made, subject to any deduction that the Employer is entitled to make under the Contract, after giving 28 days' prior notice to the Employer, with a copy to the

Engineer, suspend work or reduce the rate of work. If the Contractor suspends work or reduces the rate of work in accordance with the provisions of this Sub-Clause and thereby suffers delay or incurs costs the Engineer shall, after due consultation with the Employer and the Contractor, determine:

- (a) Any extension of time to which the Contractor is entitled under sub clause 8.7, 8.7 and 8.8 of clause 8, and
- (b) The amount of such costs, which shall be added to the Contract Price, and shall notify the Contractor accordingly, with a copy to the Employer.

18.5 Resumption of Work

Where the Contractor suspends work or reduces the rate of work, having given notice in accordance with Sub-Clause 18.4, and the Employer subsequently pays the amount due, including interest pursuant to Sub-Clause 15.12, the Contractor's entitlement under Sub-Clause 18.1 shall, if notice of termination has not been given, lapse and the Contractor shall resume normal working as soon as is reasonably possible.

Whenever the Works is resumed after suspension, the Engineer and the Contractor shall jointly examine the Works and the Plant and Materials affected by the suspension and the Contractor shall prepare a report indicating the physical status and major adverse effects, if any, the Works under suspension has suffered during the period of suspension and furnish same to the Engineer and Employer.

19 Design and drawings

19.1 Custody and Supply of Drawings and Documents

The approved drawings shall remain in the custody of the Engineer, but two copies thereof shall be provided to the Contractor free of charge. The Contractor shall make at his own cost any further copies required by him. Unless it is strictly necessary for the purposes of the Contract, the Drawings, Specification and other documents provided by the Employer or the Engineer shall not, without the consent of the Engineer, be used or communicated to a third party by the Contractor. Upon issue of the Final completion Certificate, the Contractor shall return to the Engineer all Drawings, Specification and other documents provided under the Contract.

19.2 One Copy of Drawings to be kept on Site

One copy of the Drawings, provided to the Contractor as aforesaid, shall be kept by the Contractor on the Site and the same shall at all reasonable times be available for inspection and use by the Engineer and by any other person authorised by the Engineer in writing.

19.3 **Disruption of Progress**

The Contractor shall give notice to the Engineer, with a copy to the Employer, whenever planning or execution of the Works is likely to be delayed or disrupted unless any further drawing or instruction is issued by the Engineer within a reasonable time. The notice shall include details of the drawing or instruction required and of why and by when it is required and of any delay or disruption likely to be suffered if it is late. This shall not be applicable in the case of permanent works to be designed and engineered by the contractor, except with regard to its approval by the Engineer, if specified.

19.4 **Delays and Cost of Delay of Drawings**

If, by reason of any failure or inability of the Engineer to issue, within a time reasonable in all the circumstances, any drawing or instruction for which notice has been given by the Contractor in accordance with Sub Clause 19.3, the Contractor suffers delay and/or incurs costs then the Engineer shall, after due consultation with the Employer and the Contractor, determine:

- (a) any extension of time to which the Contractor is entitled under sub clause 8.6, 8.7 and 8.8, and

19.5 **Supplementary Drawings and Instructions**

The Engineer shall have authority to issue to the Contractor, from time to time, such supplementary Drawings and instructions as shall be necessary for the purpose of the proper and adequate execution and completion of the Works and the remedying of any defects therein. The Contractor shall carry out and be bound by the same.

20 **Insurance**

20.1 **Insurance of Works**

Contractor is required to take Contractor's All Risk Policy or erection all risk policy (as the case may be) from an approved insurance company in the joint name with the Employer and bear all costs towards the same for the full period of execution of

works including the defect liability period for the full amount of contract against all loss of damage from whatever cause arising other than excepted risks for which he is responsible under the terms of the contract and in such manner that the Employer and the contractor are covered during the period of construction of works and/or also covered during the period of defect liability for loss or damage

- a) The work and the temporary works to the full value of such works.
- b) The materials, construction plant, centering, shuttering and scaffolding materials and other things brought to the site for their full value.

Whenever required by the Employer, the contractor shall produce the policy or the policies of insurance and the receipts for payment of the current premium.

20.2 **Insurance under Workmen Compensation Act**

Contractor is required to take insurance cover under the Workman Compensation Act, 1923 as amended from time to time from an approved insurance company and pay premium charges thereof. Wherever required by the Employer the contractor shall produce the policy or the policies of Insurance and the receipt of payment of the current premiums.

20.3 **Third Party Insurance**

Contractor is required to take third party insurance cover for an amount of 5% (five percent) of contract value from an approved insurance company for insurance against any damage, injury or loss which may occur to any person or property including that of the Employer, arising out of the execution of the works or temporary works. Wherever required by the Employer the contractor shall produce the policy or the policies of Insurance and the receipt of payment of the current premiums. In case of failure of the contractor to obtain contractors all risk policy, insurance under workman compensation act and third party insurance as described above within one month from the date of commencement of work, running account payments of the contractor shall be withheld till such time the aforesaid insurance covers are obtained by the contractor. If the Contractor could not effect a comprehensive insurance cover against risks which he may be required to effect under the terms of the contract, then he shall give his attention to get the best insurance cover available and even in case of effecting a wider insurance cover than the one which the subsidiary of the General Insurance Company could offer, such an insurance is ought to be done after the Employers approval, by or through the subsidiary of the General Insurance Company.

20.4 The Contractor shall at all times indemnify the Employer against all claims, damages or compensation under the provision of Payment of Wages Act-1936, Minimum Wages Act-1948, Employer's liability Act-1938, the Workmen's Compensation Act-1947, Industrial Disputes Act-1947 and Maternity Benefit Act-1961 or any modifications thereof or any other law in force or as consequence of any accident or injury to any workman or other persons in or about the works, whether in the employment of the contractor or not, against all costs, charges and expenses of any suit, action or proceedings arising out of such incident or injury and against all sum or sums which may with the consent of the contractor be paid to compromise or compound any such claim. Without limiting his obligations and liabilities as above provided, the contractor shall insure against all claims, damages or compensation payable under the Workmen's Compensation Act 1923 or any modification thereof or any other law relating thereto."

20.5 Damage to Persons and Property

The Contractor shall, except if and so far as the Contract provides otherwise, indemnify the Employer against all losses and claims in respect of:

- (a) death of or injury to any person, or
- (b) loss of or damage to any property (other than the Works), which may arise out of or in consequence of the execution and completion of the Works and the remedying of any defects therein, and against all claims, proceedings, damages, costs, charges and expenses whatsoever in respect thereof or in relation thereto, subject to the exceptions defined in Sub-Clause 20.6.

20.6 Exceptions

The "exceptions" referred to in Sub-Clause 20.5 are:

- (a) the permanent use or occupation of land by the Works, or any part thereof,
- (b) the right of the Employer to execute the Works, or any part thereof, on, over, under, in or through any land,
- (c) damage to property which is the unavoidable result of the execution and completion of the Works, or the remedying of any defects therein, in accordance with the Contract, and

-
- (d) death of or injury to persons or loss of or damage to property resulting from any act or neglect of the Employer, his agents, servants or other contractors, not being employed by the Contractor, or in respect of any claims, proceedings, damages, costs, charges and expenses in respect thereof or in relation thereto or, where the injury or damage was contributed to by the Contractor, his servants or agents, such part of the said injury or damage as may be just and equitable having regard to the extent of the responsibility of the Employer, his servants or agents or other contractors for the injury or damage.

20.7 Indemnity by Employer

The Employer shall indemnify the Contractor against all claims, proceedings, damages, costs, charges and expenses in respect of the matters referred to in the exceptions defined in Sub-Clause 20.6.

20.8 Cross Liabilities

The insurance policy shall include a cross liability clause such that the insurance shall apply to the Contractor and to the Employer as separate insured.

20.9 Accident or Injury to Workmen

The Employer shall not be liable for in respect of any damages or compensation payable to any workman or other person in the employment of the Contractor or any Subcontractor, other than death or injury resulting from any act or default of the Employer, his agents or servants. The Contractor shall indemnify and keep indemnified the Employer against all such damages and compensation, other than those for which the Employer is liable as aforesaid, and against all claims, proceedings, damages, costs, charges, and expenses whatsoever in respect thereof or in relation thereto.

20.10 Evidence and Terms of Insurances

The Contractor shall provide evidence to the Employer as soon as practicable after the respective insurances have been taken out but in any case prior to the start of work at the Site that the insurances required under the Contract have been effected and shall, within 84 days of the Commencement Date, provide the insurance policies to the Employer. When providing such evidence and such policies to the Employer, the

Contractor shall notify the Engineer of so doing. Such insurance policies shall be consistent with the general terms agreed prior to the issue of the Letter of Award. The Contractor shall effect all insurances for which he is responsible with insurers and in terms approved by the Employer.

20.11 Adequacy of Insurances

The Contractor shall notify the insurers of changes in the nature, extent or programme for the execution of the Works and ensure the adequacy of the insurances at all times in accordance with the terms of the Contract and shall, when required, produce to the Employer the insurance policies in force and the receipts for payment of the current premiums.

20.12 Remedy on Contractor's Failure to Insure

If the Contractor fails to effect and keep in force any of the insurances required under the Contract, or fails to provide the policies to the Employer within the period required by Sub-Clause 20.10, then and in any such case the Employer may effect and keep in force any such insurances and pay any premium as may be necessary for that purpose and from time to time deduct the amount so paid from any monies due or to become due to the Contractor, or recover the same as a debt due from the Contractor.

20.13 Compliance with Policy Conditions

In the event that the Contractor or the Employer fails to comply with conditions imposed by the insurance policies effected pursuant to the Contract, each shall indemnify the other against all losses and claims arising from such failure.

20.14 Source of Insurance

The Contractor shall place all insurance relating to the Contract (including, but not limited to, the insurance referred to in Clauses 20) with insurers from India.

21 Release From Performance

Payment in Event of Release from Performance

If any circumstance outside the control of both parties arises after the issue of the Letter of Award which renders it impossible or unlawful for either or both parties to fulfil his or their contractual obligations, or under the law governing the Contract the parties are released from further performance, then the parties shall be discharged from the Contract, except as to their rights under this Clause and Clause 16.3 and

without prejudice to the rights of either party in respect of any antecedent breach of the Contract, and the sum payable by the Employer to the Contractor in respect of the work executed shall be the same as that which would have been payable under Clause 14 if the Contract had been terminated under the provisions of Clause 14.

22 Notices

22.1 Notice to Contractor

All certificates, notices or instructions to be given to the Contractor by the Employer or the Engineer under the terms of the Contract shall be sent by post, cable, e-mail or facsimile transmission to or left at the Contractor's principal place of business or such other address as the Contractor shall nominate for that purpose.

22.2 Notice to Employer and Engineer

Any notice to be given to the Employer or to the Engineer under the terms of the Contract shall be sent by post, cable, e-mail or facsimile transmission to or left at the respective addresses nominated for that purpose.

22.3 Change of Address

Either party may change a nominated address to another address in the country where the Works are being executed or in the country of Employer by prior notice to the other party, with a copy to the Engineer, and the Engineer may do so by prior notice to both parties.

23 Changes in Cost and Legislation

23.1 Increase or Decrease of Cost

There shall be no addition or deduction from the Contract Price any sums in respect of rise or fall in the cost of labour and/or materials or any other matters affecting the cost of the execution of the Works as far as the items of Works covered are concerned. However, addition or deduction from the Contract Price any sums in respect of rise or fall in the cost of POL may be determined as defined in SCC.

23.2 Subsequent Legislation

If, after the date 28 days prior to the latest date for submission of tenders for the Contract there occur in the country in which the Works are being or are to be executed changes to any National or State Statute, Ordinance, Decree or other Law or any

regulation or bye-law of any local or other duly constituted authority, or the introduction of any such State Statute, Ordinance, Decree, Law, regulation or bye-law which causes additional or reduced cost to the Contractor, other than under Sub-Clause 23.1, in the execution of the Contract, such additional or reduced cost shall, after due consultation with the Employer and the Contractor, be determined by the Engineer and shall be added to or deducted from the Contract Price-and the Engineer shall notify the Contractor accordingly, with a copy to the Employer.

24 — Sustainability of JV

~~In case JV/consortium is not sustained due any reasons or discrepancies arising amongst the JV/consortium members, unsustainability of JV/consortium shall be determined by the Engineer in Charge/Employer during the monitoring in the contract period based on the failure of the deliveries/missing of the milestones and other deliverables. The same shall be dealt in the following manner:~~

~~(a) — If JV/consortium becomes unsustainable after being selected as L1 EMD of the defaulting JV/consortium shall be forfeited.~~

~~(b) — If JV/consortium becomes unsustainable after the award of contract, the employer has complete authority to nominate another contractor to complete the balance work on risk and cost of the defaulting contractor. The Contractor will be notified of the decision to stop the work and get the measurements done to ascertain the value of work completed till date. No payment shall be released immediately, however, after completion of entire work on risk and cost, the differential cost would be recovered from all held up amount (BG, EMD, Security deposit and unpaid amount for the work done) of the defaulting Contractor and if any balance amount is still available, that shall be released to the defaulting Contractor.~~

25 Independent Relationship

Notwithstanding anything contained in this Agreement, the relationship between the Employer and the Contractor shall always remain on a principal to principal basis and the Contractor shall never declare / claim himself to be an agent of the Employer. The Contractor shall alone be responsible for all its action / omission of the Contractor shall bind the Employer in any manner unless expressly so provided in this Agreement.

26 When the Contract can be determined

26.1 Subject to other provisions contained in this clause, the Engineer-in-Charge may, without prejudice to his any other rights or remedy against the contractor in respect of any delay, inferior workmanship, any claims for damages and/or any other provisions of this contract or otherwise, and whether the date of completion has or has not elapsed, by notice in writing absolutely determine the contract in any of the following cases:

- i. If the contractor having been given by the Engineer-in-Charge a notice in writing to rectify, reconstruct or replace any defective work or that the work is being performed in an inefficient or otherwise improper or un-workman like manner shall omit to comply with the requirement of such notice for a period of seven days thereafter.
- ii. If the contractor has, without reasonable cause, suspended the progress of the work or has failed to proceed with the work with due diligence so that in the opinion of the Engineer-in-Charge he will be unable to secure completion of the work by the date for completion and continues to do so after a notice in writing of seven days from the Engineer-in--Charge.
- iii. If the contractor fails to complete the work within the stipulated date or items of work with individual date of completion, if any stipulated, on or before such date(s) of completion and docs not complete them within the period specified in a notice given in writing in that behalf by the Engineer-in-Charge.
- iv. If the contractor persistently neglects to carry out his obligations under the contract and/ or commits default in complying with any of the terms and conditions of the contract and docs not remedy it or take effective steps to remedy it within 7 days after a notice in writing is given to him in that behalf by the Engineer- in-Charge.
- v. If the contractor shall offer or give or agree to give to any person in IWAI service. or to any other person on his behalf any gift or consideration of any kind as an inducement or reward for doing or forbearing to do or for having done or forborne to do any act in relation to the obtaining or execution of contract.

-
- vi. If the contractor shall obtain a contract with IWAI as a result of wrong tendering or other non-bonafide methods of competitive tendering or commits breach of integrity pact.
- vii. If the contractor being an individual, or if a firm, any partner thereof shall at any time be adjust insolvent or have a receiving order or order for administration of his estate made against him or shall take any proceedings for liquidation or composition (other than a voluntary liquidation for the purpose of amalgamation or reconstruction) under any Insolvency Act for the time being in force_ or make any conveyance or assignment of his effects or composition or arrangement for the benefit of his creditors or purport so to do, or if any application be made under any Insolvency Act for the time being enforce for the sequestration of his estate or if a trust deed be executed by him for benefit of his creditors.
- viii. If the contractor being a company shall pass a resolution or the court shall make an order that the company shall be wound up or if a receiver or a manager on behalf of a creditor shall be appointed or if circumstances shall arise which entitle the court or the creditor to appoint a receiver or a manager or which entitle the court to make a winding up order.
- ix. If the contractor shall suffer an execution being levied on his goods and allow it to be continued for a period of 21 days.
- x. If the contractor assigns, transfers, sublets (engagement of labour on a piece-work basis or of labour with materials not to be incorporated in the work, shall not be deemed to be subletting) or otherwise parts with or attempts to assign, transfer, sublet or otherwise parts with the entire works or any portion thereof without the prior written approval of the Engineer -in-Charge.
- 26.2 When the contractor has made himself liable for action under any of the cases aforesaid, the Engineer- in-Charge on behalf of the IWAI with the approval of the competent authority shall have powers:
- i. To determine the contract as aforesaid (of which termination notice in writing to the contractor under the hand of the Engineer-in-Charge shall be conclusive evidence). Upon such determination, the Earnest Money Deposit, Security Deposit already recovered and Performance Guarantee under the contract shall be liable to be forfeited and shall be absolutely at the disposal of the IWAI.

-
- ii. After giving notice to the contractor to measure up the work of the contractor and to take such whole, or the balance or part thereof: as shall be un-executed out of his hand and to give it to another contractor to complete the work. The contractor, whose contract is determined as above, shall not be allowed to participate in the tendering process for the balance work.
- iii. the event of above courses being adopted by the Engineer-in-Charge, the contractor shall have no claim to compensation for any loss sustained by him by reasons of his having purchased or procured any materials or entered into any engagements or made any advances on account or with a view to the execution of the work or the performance of the contract. And in case action is taken under any of the provision aforesaid, the contractor shall not be entitled to recover or be paid any sum for any work thereof or actually performed under this contract unless and until the Engineer-in-Charge has certified in writing the performance of such work and the value payable in respect thereof and he shall only be entitled to be paid the value so certified.

SECTION - VIII: SPECIAL CONDITIONS OF CONTRACT (SCC)

1. General

- 1.1. Special Conditions shall be read in conjunction with the General Conditions of Contract, specification, ToR, Drawings and any other documents forming part of this contract wherever the context so requires.
- 1.2. Notwithstanding the Sub-division of the documents in to these separate section and volume every part of each shall be deemed to be supplementary to and complementary of every other part and shall be read with and as a part of the Contract.
- 1.3. Where any portion of the general Conditions of Contract is repugnant to or at variance with any provisions of the Special Conditions, the provisions of the Special Conditions shall be deemed to over-ride the provisions of the General Conditions of Contract.
- 1.4. Where it is mentioned in the Specification that the contractor shall perform certain work or provide certain facilities, it is understood that the contractor shall do so at his own cost.
- 1.5. The materials and workmanship shall satisfy the relevant standards as stipulated under the Contract Agreement, the specification conditioned herein and codes referred to. Where the specifications stipulate requirement in addition to those contained in the Standard codes and specifications these additional requirements shall also be satisfied.

2. The Site

2.1 General Site Information

The Contractor shall visit the site and satisfy themselves on the actual site conditions, meteorological and other data, before tendering. Whatever information and, other relevant data given in the tender documents are only intended as a general guidance for the contractor and no warranty is given for the correctness of the same.

2.2 Condition of Site

The Contractor, before carrying out any work, shall inspect the Site in conjunction with the Engineer's Representative to establish its general condition which shall be agreed and recorded in writing, and where, in the opinion of the Engineer or his Representative it is deemed necessary, by means of photography.

The boundary of the land earmarked for the execution of the Works shall be defined by the Engineer's Representative and the Contractor shall provide, erect and maintain

from commencement to final completion of all work and all reinstatement substantial galvanized pipes or similar approved markers indicating the boundary of the working area at regular intervals as the Engineer's Representative may require. In the event of any such boundary marker / post being disturbed or displaced as a result of the Contractor's operations or theft, the Contractor shall forthwith at his own expense replace the same and maintain the boundary properly.

3. Order of Works

The order in which the works are to be carried out by the Contractor shall be to the approval of Employer and shall be such as to suit the detailed method of construction, adopted by the Contractor as well as the Work Plan / Overall Schedule approved by the Employer. The works shall be carried out in such a manner so as to enable the other Contractors to work concurrently so that the entire project may be brought into use immediately after the completion of works.

4. General Conditions of Construction and Erection Work

- 4.1 The work shall be permitted on the site round the clock.
- 4.2 The contractor must arrange for the placement of workers in such a way that the delayed completion of the works of any part thereof for any reason whatsoever will not affect their proper employment. The Employer will not entertain any claim for over time /idle time payment etc. whatsoever.
- 4.3 The Contractor shall submit to Employer / Engineer-in-Charge reports at regular intervals regarding the state and progress of work. The details and proforma of the report will mutually be agreed after the award of Contract.

5. Surveys and Levels

- 5.1 Before the works of any part thereof begin, the Contractor shall survey and take levels of the site of the works both above and below water level / Chart Datum level, and agree all particulars on which the measurements of the works are to be based. Such particulars shall be recorded and after agreement; the drawings shall be signed by the Employer / Engineer-In-Charge and the Contractor.
- 5.2 Failing such surveys and agreements being prepared and/or signed by the Contractor, the survey carried out by the Engineer shall be final and binding on the Contractor.

6. Setting out the Works

- 6.1 The Employer shall furnish the relevant existing grid points with bench Mark with reference to permanent bench marks. It shall be Contractor's responsibility to the set out the necessary central points on land and to set out alignment. The Contractor shall have in his employees, an efficient survey team for this purpose and the accuracy of such setting out works shall be Contractor's sole responsibility.
- 6.2 Before beginning the work the Contractor shall work out the control points on ground which, are pre requisite for carrying out hydrographic surveys, accurately, with suitable markers as approved by Employer. All these points and markings shall be checked and approved by Employer's Representative before starting the work.
- 6.3 The Contractor shall also provide necessary equipment, labour and other facilities for proper checking and inspection of the fabrication, welding, painting and any other such activity forming part of the total scope of the work at no cost to the Employer.
- 6.4 The Contractor shall give Employer not less than 24 hours' notice in writing of his intention to inspect for any part of the works so that arrangements may be made for checking the work.
- 6.5 The Contractor shall at his own expense provide all assistance which Employer or his representative may require for checking and inspection.

7. Conditions for work

- 7.1 The decision of EIC to accept the work done with or without the Liquidated damages shall be final and binding.
- 7.2 No idle time charges will be paid to the contractor on any account.
- 7.3 The Employer / Engineer-in-charge or his representative will inspect, co-ordinate, measure and certify the work. He has the right to inspect at any time during the contract period for which contractor's authorized agent shall be available at site during such inspection.

-
- 7.4 The Contractor may execute the work round the clock and on all days including Sundays and Public Holidays except National Holidays subject to such restriction as may be imposed by State Govt./local body or Engineer In Charge.
- 7.5 If the Contractor's personnel or any outside labour employed to work during execution of Contract, breaks or damages/destroys any vessel, craft, net, fishing stakes etc. building, road, kerb, water pipe, fence, bund, wires, trees, crop, fruit or cultivated ground during the period of agreement, the same shall be made good by the Contractor at his own expenses or in default the IWAI may cause the same to be made good by other sources and deduct the expenses from any sums that may be then or at any time thereafter may become due to the contractor.
- 7.6 The rate quoted shall include all taxes, duties and any other levies. No additional payment on any such account shall be payable by IWAI. However, GST which will be quoted separately by the Bidder will be reimbursed to the Bidder on producing proof of payment
- 7.7 The right to award/split up work or to reject the offer without assigning any reason is reserved with the Authority.
- 7.8 If the work is stopped continuously for more than 3 days due to law and order, the Contractor has to report to EIC the same and take actions mutually in accordance with prevailing local laws for removal of such problem and proceeding further with the work to mutual benefit.
- 7.9 Any charge incurred for adopting environmental safe guards, minimizing detrimental impacts, enhancing the beneficial aspects of the project and for effective management of the environmental resources affected by the project shall be met by the Contractor. No additional charges on any account shall be payable by IWAI.

8. Standard and Standard Products

8.1 Standards

Save in so far otherwise specified in the Contract the relevant provisions of the appropriate Bureau of Indian Standards shall apply for all materials and workmanship. Where relevant BIS standards do not exist, the latest version of the relevant standards in vogue shall be applied. Where both above Standards may not be available, the following Standards shall also be referred to and adopted.

-
- BS : British Standard Specification
 - CP : British Standard Code of Practice
 - ASTM : Standard of American Society for Testing Materials.

8.2 Standard Products

If mention is made in the Contract of named products of individual manufacturers, this is an indication of the standard type and workmanship of goods, which are satisfactory to the Engineer. The Contractor may substitute similar products of at least equal quality and suitability, subject to the approval of the Engineer.

Proposals by the Contractor for the supply of manufactured products shall be accompanied by certification that the manufacturer's products are approved by the relevant standards authority.

9. Security and Safety

- 9.1 The Contractor shall comply with all regulations imposed by the Central / State / Local Authorities and Employer in respect of the passage of Plant, Vehicles, materials and personnel through waterways.
- 9.2 The Contractor shall take all possible precautions to prevent out breaks of fire on the site and in all offices, stores, camps and other places and things connected therewith and especially with respect to the safe storage of petroleum products, explosives and all other dangerous or hazardous goods. The Contractor shall comply with all rules, regulations and orders of any Statutory Authority and of Employer at no extra cost to the Employer.
- 9.3 The Contractor shall obtain from the Employer details of any restricted areas in or around the site and shall have prominently and clearly displayed for the information of his staff and work people notices defining any such restricted areas. Such notices shall be provided at his own expenses.
- 9.4 If required, the Contractor shall take entry passes to the restricted areas for all personnel labourers and vehicle. No claim whatsoever on this account will be entertained.

10. Health Safety and Environment, Risk & Hazard

10.1 The Contractor shall prepare and submit to the Employer / Employer-In-Charge the Health Safety and Environment (HSE) Plan in line with Employers HSE policy and Contractors company policy within 28 days of commencing of works for the approval of the Employer. The policy shall be followed during the life cycle of the project. The policy may be updated as and when required.

10.2 The Contractor shall prepare and submit the Risk and Hazard identification and mitigation plan within 28 days of commencing of works for approval of the Employer. The plan may be updated as and when required.

11. Taxes, duties and levies etc.

The prices shall include all the taxes, levies, cess, octroi, royalty, terminal tax, excise, GST or any other local, State or Central taxes as applicable/ charged by Centre or State Government or Local authorities on all materials that the contractor has to purchase for the performance of the contract and services, shall be payable by the contractor and the Authority will not entertain any claim for compensation whatsoever in this regard.

12. Additional Conditions

In addition to the above mentioned SCC the following table shall also form part of SCC which are to be read in conjunction with relevant GCC Clause:

GCC Clause	Heading	Definitions
1.3	Language for Communication	English
2.3	Right of access to site	-
3.1.2.4 (ii)	Percentage of variation under Engineer's duty and Authority	20 % (twenty percent) subject to a maximum of 50%..
4.4	Performance security and security deposit	5% each. It Shall be released only after the completion of defects liability period.
4.7 (b)	Unforeseeable Physical Obstructions or	No cost on any account due to unforeseeable physical obstructions or conditions shall be

	Conditions	added to the Contract Price
4.9.1	Program to Be Submitted	14 days
4.9.3	Cash Flow Estimate	14 days and subsequently submit the revised cash flow estimate at mutually agreed interval
5.4.4 & 5.4.5	Payments to Nominated Subcontractors	<p>The GCC clause 5.4.4 & 5.4.5 shall now be read as:</p> <p>Contractor shall be entirely responsible for all the payments to be made to the nominated sub-contractor.</p> <p>Contractor shall hold employer indemnified against all claims arising from sub-contracting of works.</p> <p>The contractor shall produce No claim Certificate from the sub-contractors at the demand of EIC, before final bill payment.</p> <p>Contractor shall not be absolved of his responsibilities and duties of the contract by nominating sub-contractors.</p>
8.5	Time for completion	5 months from the signing of agreement
8.12	Limit of Liquidated Damages	10 percent of the Contract Price.
10.2 & 10.3	Taking over of sections or parts	There shall be no taking over of sections or parts. Only interim completion certificate and final completion certificate shall be given as per the conditions of contract.
11.0	Defects Liability Period	12 months
15.2 (b)	Minimum Amount of Interim Payment (stage	Interim Payment Certificates

	wise)	
15.13	Maximum Amount of Advance Payment	<p>10 percent of the Contract Price. The Contractor shall submit a bank guarantee for an amount equivalent to 100% of the advance payment requested by the contractor.</p> <p>The Bank Guarantee so submitted shall be valid for entire contract period and it shall be returned to the contractor after the advance payment has been recovered.</p> <p>The Bank Guarantee shall be submitted as per annex - 1</p>
15.13	Repayment of Advance Payment	After certification of 10 percent of the Contract Price.

SECTION-IX: ANNEXES

ANNEX - I: BANK GUARANTEE FORM FOR PERFORMANCE SECURITY

To

The Chairman

Inland waterways Authority of India

Ministry of Shipping, Govt. of India

A-13, Sector-1,

Noida(U.P.)

Pin- 201301

In consideration of the (hereinafter called "**Employer**") having to enter into an Agreement with M/s (hereinafter called the "**Contractor**") as a follow up to the Letter of Award no.....dated..... issued by the Employer for for Design, construction, supply installation, testing and commissioning of 10 nos. Concrete Jetties in New National Waterways in J&K on production of Performance security in the form of Bank Guarantee for INR (Rupees.....only), at the request of **Contractor**, We, (**Bank**) do hereby undertake to pay to the Employer an amount not exceeding INR..... (Rupees-----only) against any default or failure on the part of Contractor to perform the contract in accordance with terms & conditions or any breach of the said Agreement.

1. We, (**Bank**) do hereby undertake to pay the amount due and payable under this Guarantee without any demur, merely on a demand from the Employer stating that the amount claimed is due by way of loss or damage caused to or would be caused to or suffered by the Employer by reason of breach by the said **Contract** or any of the terms or conditions contained in the said time frame or by reason of the **Contractor's** failure to perform the said Agreement. Any such demand made on the Bank shall be conclusive as regards the amount due and payable by the Bank under this guarantee. However, our liability under this guarantee shall be restricted to an amount not exceeding INR..... (Rupees.....only).
2. We, (**Bank**) undertake to pay the Employer any money so demanded notwithstanding any dispute or disputes raised by the **Contractor** in any suit or proceeding pending before any court or Tribunal relating thereto, liability under this present being absolute and unequivocal. The payment so made by us under this guarantee shall be

valid discharge of our liability for payment there under and the **Contractor** shall have no claim against us for making such payment.

3. We, (**Bank**) further agree that the guarantee herein contained shall remain in full force and effect till completion of project work to the complete satisfaction of the Employer in terms of conditions of contract and Letter of Award and that it shall continue to be enforceable till all the dues of the Employer under or by virtue of the said Agreement have been fulfilled and its claim satisfied or till the scheduled date of completion of Works as per the Agreement. We(Bank) shall consider that the terms and conditions of the said Agreement have been fully and properly carried out by the said **Contractor** and accordingly discharge this Guarantee after 90 days from the date of completion of the said contract unless a demand or claim under this Guarantee is served by the Employer in writing on the bank but before the expiry of the said period in which case it shall be enforceable against the bank notwithstanding the fact that the same is enforced after the expiry of the said period or after the extended period as the case may be.
4. We (**Bank**) further agree with the Employer that the Employer shall have fullest liberty without our consent and without affecting in any manner our obligations hereunder to vary any of the terms and conditions of the said Agreement or to extend time or performance by the said **Contractor** from time to time or to postpone for any time or from time to time any of the powers exercisable by the Employer against the said **Contractor** and to forbear or enforce any of the terms and conditions relating to the said Agreement and we shall not be relieved from our liability by reason of any such variation, or extension being granted to the said **Contractor** or for any forbearance, act or omission on the part of the Employer or any indulgence by the Employer to the said **Contractor** or by any such matter or thing whatsoever which under the law relating to sureties would, but for the provision, have effect of so relieving us.
5. It shall not be necessary for the Employer to proceed against the **Contractor** before proceeding against the Bank and the guarantee herein contained shall be enforceable against the bank notwithstanding any security which the Employer may have obtained or obtain from the **Contractor** at the time when proceedings are taken against the bank hereunder be outstanding or unrealized.

-
6. Notwithstanding anything contained herein above our liability under the guarantee is restricted to INR(Rupees..... only) and shall remain in force until or otherwise until the extended date by the Employer. Unless a claim or suit under this guarantee is filed with us on or before or the extended date ALL YOUR RIGHTS UNDER THE GUARANTEE SHALL BE FORFEITED and the bank shall be relieved and discharged from all liabilities therein.
7. This Guarantee will not be discharged due to the change in the constitution of the Bank or the **Contractor**.
8. We, (**Bank**) lastly undertake not to revoke this Guarantee during its currency except with the previous consent of the Employer in writing.

Dated the of 2009
for
(Indicate the name of bank)

Signature.....

Name of the Officer
(In Block Capitals)
Designation

Code No.
Name of the bank and Branch.(SEAL)

ANNEX - II: AGREEMENT FORM

Tender for Design, construction, supply installation, testing and commissioning of 10 nos. Concrete Jetties in New National Waterways in J&K

AGREEMENT BETWEEN

INLAND WATERWAYS AUTHORITY OF INDIA

AND

CONTRACTING FIRM

This agreement made on thisday of Two thousand.....between Inland Waterways Authority of India, A – 13, Sector – 1, Noida - 201 301, U.P. (hereinafter called the "IWAI" which expression shall unless excluded by or repugnant to the context be deemed to include their successor in office) on the one part and M/S.....having its office at(hereinafter called " Contractor "which expression shall unless excluded by or repugnant to the context be deemed to include their heirs, executors, administrators, representatives and assigns or successor in office) on the other part.

WHEREAS IWAI is desirous of Design, construction, supply installation, testing and commissioning of 10 nos. Concrete Jetties in New National Waterways in J&Kas per the work Order No.datedin accordance with the ToR & conditions of contract attached hereto all of which will form part of this agreement.

WHEREAS THE CONTRACTING FIRM has agreed to undertake the Tender for Design, construction, supply installation, testing and commissioning of 10 nos. Concrete Jetties in New National Waterways in J&K on Terms and Conditions herein after set forth.

NOW THEREFORE THESE PRESENTS WITNESS and it is hereby agreed, declared by and between the parties hereto as follows:

The Contractor shall undertake the Tender for Design, construction, supply installation, testing and commissioning of 10 nos. Concrete Jetties in New National Waterways in J&K as per the work Order No. dated in accordance with the ToR & conditions of contract attached hereto all of which will form part of this agreement.

The following documents shall be deemed to form and to be read and construed as part of the agreement i.e.

-
- a) Agreement Form
 - b) Integrity Agreement
 - c) Letter of Acceptance
 - d) Conditions of contract
 - e) Schedule of the price bid.
 - f) Technical Bid No. with Date
 - g) Addenda/Corrigenda
 - h) Minutes of Pre-bid Meeting
 - i) All Correspondence
 - j)
 - k)

In WITNESS whereof the IWAI has caused Shrion their behalf to hereunto set his hand and the Contractor has caused Shri on their behalf to hereunto set his hand and the firm has caused its common seal to be affixed hereunto the day and year first above written.

Witnesses, IWAI

- 1)
- 2)

And this deed was duly executed by Shri.....for the Contractor above named in the presence of

Witnesses of Contractor

- 1)
- 2)

ANNEX -III:DETAILS OF BANK ACCOUNT

**FOR RELEASE OF PAYMENT THROUGH
ELECTRONIC FUND TRANSFER SYSTEM
(TO BE FURNISHED BY THE BIDDER ON ITS LETTER HEAD)**

NAME OF THE PROJECT: _____

We _____(Name of the Bidder) hereby request you to give our payments by crediting our bank account directly by E-payment mode as per account details given below. We hereby undertake to intimate IWAI in case of any change in particulars given below and will not hold IWAI responsible for any delay / default due to any technical reasons beyond IWAI's control:-

Bank Account Number : _____

RTGS/NEFT/IFSC CODE : _____

NAME OF THE BANK : _____

ADDRESS OF THE BRANCH : _____

OF THE BANK

BRANCH CODE : _____

ACCOUNT TYPE

(SAVING/CURRENT/OTHERS) : _____

A BLANK CHEQUE (CANCELLED) IS ENCLOSED HEREWITH.

IWAI hereby declare that the particulars given above are correct and complete. If the transaction is delayed or credit is not affected at all for reasons of incomplete or incorrect information, I/We would not hold IWAI responsible.

Signature of Authorized Signatory

Name & Designation

Date:

Place

ANNEX-IV: BANK CERTIFICATION

It is certified that above mentioned beneficiary holds a Bank Account No. with our branch and the bank particulars mentioned above are correct.

Authorized Signatory
Authorization

Date:

No. _____

Name: _____

Official Seal/Stamp

ANNEX-V: TENDER ACCEPTANCE LETTER

(To be given on Company Letter Head)

To,

Dated:

The Member (Tech)

INLAND WATERWAYS AUTHORITY OF INDIA,

A-13, Sector – 1, Noida - 201 301,

District: - Gautam Buddha Nagar (U.P.)

Sub: Acceptance of Terms & Conditions of Tender.

Tender Reference No:

Name of Tender/Work: - Tender for Design, construction, supply installation, testing and commissioning of 10 nos. Concrete Jetties in New National Waterways in J&K

Dear Sir,

1. I / We have downloaded /obtained the Tender document(s) for the above mentioned 'Tender/Work' from the website(s) namely: www.iwai.nic.in OR <https://eprocure.gov.in/eprocure/appas> per your advertisement, given in the above mentioned website(s).
2. I / We hereby certify that I / we have read the entire Terms and Conditions of the Tender documents from Page No. _____ to _____ (including all documents like annexure(s), schedule(s) etc), which form part of the contract agreement and I / we shall abide hereby by the terms/conditions/clauses contained therein.
3. The minutes of the pre-bid meeting(if any) and/ or corrigendum(s)(if any) issued from time to time by your department/organisation for this work too have also been taken into consideration, while submitting this acceptance letter.
4. I / We hereby unconditionally accept the Tender conditions of above mentioned Tender document(s)/minutes of the Pre-bid Meeting (if any)/corrigendum(s) (if any) in its totality / entirety.
5. In case any provisions of this Tender are found violated , then your department/ organisation shall without prejudice to any other right or remedy be at liberty to reject this Tender/Bid including the forfeiture of the full said earnest money deposit absolutely.

Yours Faithfully

(Signature of the Bidder, with Official)

ANNEX-VI: LETTER OF CONSENT

(To be filled up by Sub-contractor and submitted in Enclosure II of this tender document)

Sub-contractor's Name: [insert full name]

Applicant's Name: [insert full name]

Date: [insert day, month, year]

Tender No. and title: [insert Tender number and title]

Dear Sir,

The invitation for tendering for [insert name of work] has been called by [insert name of employer].

In this regard, this is an undertaking that [insert name of Sub-contracting firm] having its office at [insert address of the Sub-contracting firm] is willing to participate as sub-contractor for [insert brief work details for which sub-contractor will provide services] with [insert name of applicant] for this project and we are submitting our relevant experience client certificates for the same.

[Insert name, signature and seal of authorized representative of the Sub-contractor]

ANNEX-VII: INTEGRITY AGREEMENT

To be signed by the bidders' and the same is to be signed by Authorized Signatory/competent Employer on behalf of IWAI.

INTEGRITY AGREEMENT

This Integrity Agreement is made at on thisday of 2024

BETWEEN

Chairperson, Inland Waterways Authority of India represented through Member (Tech),
Inland Waterways Authority of India, A - 13, Sec. – 1, Noida.

IWAI, (Hereinafter referred as the 'Principal/Owner', which expression shall unless repugnant to the meaning or context hereof include its successors and permitted assigns)

AND

.....

(Name and Address of the Individual/firm/Company)

through(Hereinafter referred to as the

(Details of duly authorized signatory)

"Bidder/Contractor" and which expression shall unless repugnant to the meaning or context hereof include its successors and permitted assigns)

Preamble

WHEREAS the Employer has floated the Tender (NIT No.: IWAI/)
(hereinafter referred to as "Tender/Bid") and intends to award, under laid down organizational procedure, contract for Tender for Design, construction, supply installation, testing and commissioning of 8 nos. Concrete Jetties in New National Waterways

.

AND WHEREAS the Employer values full compliance with all relevant laws of the land, rules, regulations, economic use of resources and of fairness/transparency in its relation with its Bidder(s) and Contractor(s).

AND WHEREAS to meet the purpose aforesaid both the parties have agreed to enter into this Integrity Agreement (hereinafter referred to as "Integrity Pact" or "Pact"), the terms and conditions of which shall also be read as integral part and parcel of the Tender/Bid documents and Contract between the parties.

NOW, THEREFORE, in consideration of mutual covenants contained in this Pact, the parties hereby agree as follows and this Pact witnesses as under:

Article 1: Commitment of the Principal/Owner

- 1) The Employer commits itself to take all measures necessary to prevent corruption and to observe the following principles:
 - (a) No employee of the Principal/Owner, personally or through any of his/her family members, will in connection with the Tender, or the execution of the Contract, demand, take a promise for or accept, for self or third person, any material or immaterial benefit which the person is not legally entitled to.
 - (b) The Employer will, during the Tender process, treat all Bidder(s) with equity and reason. The Employer will, in particular, before and during the Tender process, provide to all Bidder(s) the same information and will not provide to any Bidder(s) confidential / additional information through which the Bidder(s) could obtain an advantage in relation to the Tender process or the Contract execution.
 - (c) The Employer shall endeavour to exclude from the Tender process any person, whose conduct in the past has been of biased nature.
- 2) If the Employer obtains information on the conduct of any of its employees which is a criminal offence under the Indian Penal code (IPC)/Prevention of Corruption Act, 1988 (PC Act) or is in violation of the principles herein mentioned or if there be a substantive suspicion in this regard, the Employer will inform the Chief Vigilance Officer and in addition can also initiate disciplinary actions as per its internal laid down policies and procedures.

Article 2: Commitment of the Bidder(s)/Contractor(s)

1. It is required that each Bidder/Contractor (including their respective officers, employees and agents) adhere to the highest ethical standards, and report to the IWAI all suspected acts of fraud or corruption or Coercion or Collusion of which it has knowledge or becomes aware, during the tendering process and throughout the negotiation or award of a contract.

-
2. The Bidder(s)/Contractor(s) commit himself to take all measures necessary to prevent corruption. He commits himself to observe the following principles during his participation in the Tender process and during the Contract execution:
- a) The Bidder(s)/Contractor(s) will not, directly or through any other person or firm, offer, promise or give to any of the Principal/Owner's employees involved in the tender process or execution of the contract or to any third person any material or other benefit which he/she is not legally entitled to, in order to obtain in exchange any advantage of any kind whatsoever during the Tender process or during the execution of the contract.
 - b) The Bidder(s)/Contractor(s) will not enter with other Bidder(s) into any undisclosed agreement or understanding, whether formal or informal. This applies in particular to prices, specifications, certifications, subsidiary contracts, submission or non-submission of bids or any other actions to restrict competitiveness or to cartelize in the bidding process.
 - c) The Bidder(s)/Contractor(s) will not commit any offence under the relevant IPC/PC Act. Further the Bidder(s)/Contractor(s) will not use improperly, (for the purpose of competition or personal gain), or pass on to others, any information or documents provided by the Employer as part of the business relationship, regarding plans, technical Bids and business details, including information contained or transmitted electronically.
 - d) The Bidder(s)/Contractor(s) of foreign origin shall disclose the names and addresses of agents/representatives in India, if any. Similarly Bidder(s)/Contractor(s) of Indian Nationality shall disclose names and addresses of foreign agents/representatives, if any. Either the Indian agent on behalf of the foreign principal or the foreign principal directly could bid in a tender but not both. Further, in cases where an agent participate in a tender on behalf of one manufacturer, he shall not be allowed to quote on behalf of another manufacturer along with the first manufacturer in a subsequent/parallel tender for the same item.
 - e) The Bidder(s)/Contractor(s) will, when presenting his bid, disclose any and all payments he has made, is committed to or intends to make to agents, brokers or any other intermediaries in connection with the award of the Contract.

-
3. The Bidder(s)/Contractor(s) will not instigate third persons to commit offences outlined above or be an accessory to such offences.
 4. The Bidder(s)/Contractor(s) will not, directly or through any other person or firm indulge in fraudulent practice means a wilful misrepresentation or omission of facts or submission of fake/forged documents in order to induce public official to act in reliance thereof, with the purpose of obtaining unjust advantage by or causing damage to justified interest of others and/or to influence the procurement process to the detriment of the Government interests.
 5. The Bidder(s)/Contractor(s) will not, directly or through any other person or firm use Coercive Practices (means the act of obtaining something, compelling an action or influencing a decision through intimidation, threat or the use of force directly or indirectly, where potential or actual injury may befall upon a person, his/ her reputation or property to influence their participation in the tendering process).

Article 3: Consequences of Breach

Without prejudice to any rights that may be available to the Employer under law or the Contract or its established policies and laid down procedures, the Employer shall have the following rights in case of breach of this Integrity Pact by the Bidder(s)/Contractor(s) and the bidder/Contractor accepts and undertakes to respect and uphold the Principal/Owner's absolute right:

1. If the Bidder(s)/Contractor(s), either before award or during execution of Contract has committed a transgression through a violation of Article 2 above or in any other form, such as to put his reliability or credibility in question, the Employer after giving 14 days' notice to the Contractor shall have powers to disqualify the Bidder(s)/Contractor(s) from the tender process or terminate/determine the Contract, if already executed or exclude the Bidder/Contractor from future contract award processes. The imposition and duration of the exclusion will be determined by the severity of transgression and determined by the Principal/Owner. Such exclusion may be forever or for a limited period as decided by the Principal/Owner.
2. Forfeiture of EMD/Performance Guarantee/Security Deposit: If the Employer has disqualified the Bidder(s) from the tender process prior to the award of the contract or terminated/determined the contract or has accrued the right to terminate/determine the contract according to Article 3(1), the Employer apart from exercising any legal rights that may have accrued to the Principal/Owner, may in its considered opinion forfeit

the entire amount of Earnest Money Deposit, Performance Guarantee and Security Deposit of the Bidder/Contractor.

3. Criminal Liability: If the Employer obtains knowledge of conduct of a bidder or Contractor, or of an employee or a representative or an associate of a bidder or Contractor which constitutes corruption within the meaning of IPC Act, or if the Employer has substantive suspicion in this regard, the Employer will inform the same to law enforcing agencies for further investigation.

Article 4: Previous Transgression

- 1) The Bidder declares that no previous transgressions occurred in the last 5 years with any other Company in any country confirming to the anticorruption approach or with Central Government or State Government or any other Central/State Public Sector Enterprises in India that could justify his exclusion from the Tender process.
- 2) If the Bidder makes incorrect statement on this subject, he can be disqualified from the Tender process or action can be taken for banning of business dealings/ holiday listing of the Bidder/Contractor as deemed fit by the Principal/ Owner.
- 3) If the Bidder/Contractor can prove that he has resorted / recouped the damage caused by him and has installed a suitable corruption prevention system, the Employer may, at its own discretion, revoke the exclusion prematurely.

Article 5: Equal Treatment of all Bidders/Contractors

- 1) The Bidder/Contractor shall be responsible for any violation(s) of the principles laid down in this agreement/Pact by any of its sub-vendors.
- 2) The Employer will enter into Pacts on identical terms as this one with all Bidders and Contractors.
- 3) The Employer will disqualify Bidders, who do not submit, the duly signed Pact between the Employer and the bidder, along with the Tender or violate its provisions at any stage of the Tender process, from the Tender process.

Article 6: Duration of the Pact

This Pact begins when both the parties have legally signed it. It expires for the Contractor 12 months after the completion of work under the contract.

If any claim is made/lodged during the time, the same shall be binding and continue to be valid despite the lapse of this Pacts as specified above, unless it is discharged/determined by the Employer.

Article 7: Other Provisions

- 1) This Pact is subject to Indian Law, place of performance and jurisdiction is the Headquarters of the Division of the Employer, who has floated the Tender.
- 2) Changes and supplements need to be made in writing. Side agreements have not been made.
- 3) If the Contractor is a partnership or a consortium, this Pact must be signed by all the partners or by one or more partner holding power of attorney signed by all partners and consortium members. In case of a Company, the Pact must be signed by a representative duly authorized by board resolution.
- 4) Should one or several provisions of this Pact turn out to be invalid; the remainder of this Pact remains valid. In this case, the parties will strive to come to an agreement to their original intensions.
- 5) It is agreed term and condition that any dispute or difference arising between the parties with regard to the terms of this Integrity Agreement / Pact, any action taken by The Employer/Principal in accordance with this Integrity Agreement/ Pact or interpretation thereof shall not be subject to arbitration.

Article 8: LEGAL AND PRIOR RIGHTS

All rights and remedies of the parties hereto shall be in addition to all the other legal rights and remedies belonging to such parties under the Contract and/or law and the same shall be deemed to be cumulative and not alternative to such legal rights and remedies aforesaid. For the sake of brevity, both the Parties agree that this Integrity Pact will have precedence over the Tender/Contact documents with regard any of the provisions covered under this Integrity Pact.

IN WITNESS WHEREOF the parties have signed and executed this Integrity Pact at the place and date first above mentioned in the presence of following witnesses:

.....

(For and on behalf of Employer)

.....

(For and on behalf of Bidder/Contractor)

WITNESSES:

1.

(signature, name and address)

2.

(signature, name and address)

Place:

Date :



ANNEX-VIII: General Drawing for connection of gangway.