

TENDER DOCUMENT

FOR
PROVIDING & FIXING OF RUBBER FENDERS AND REPLACEMENT
OF DAMAGED/RUSTED CHAINS AND PLATES FITTED WITH
RUBBER FENDERS IN VARIOUS IWAI TERMINALS



JUNE 2024

TENDER NO. IWAI/COCH/FEN/59/2024-25/32



भारतीय अंतर्देशीय जलमार्ग प्राधिकरण

INLAND WATERWAYS AUTHORITY OF INDIA

(Ministry of Ports, Shipping and Waterways, Govt. of India)

(पत्तन, पोत परिवहन और जलमार्ग मंत्रालय, भारत सरकार)

National Waterway Road, Kannadikkadu, Maradu P.O,

NH 47 Bypass, Ernakulam, Kerala. PIN: 682 304.

E mail:- dirkoc.iwai@nic.in. Web Site:- www.iwai.nic.in

<https://eprocure.gov.in/eprocure/app>

DISCLAIMER

1. This Tender document is neither an agreement nor an offer by the Inland Waterways Authority of India (IWAI) to the prospective Bidders or any other person. The purpose of this Tender is to provide information to the interested parties that may be useful to them in the formulation of their Bid pursuant to this Tender.
2. IWAI does not make any representation or warranty as to the accuracy, reliability or completeness of the information in this Tender document and it is not possible for IWAI to consider particular needs of each party who reads or uses this Tender document. This Tender includes statements which reflect various assumptions and assessments arrived at by IWAI in relation to the Construction Works. Such assumptions, assessments and statements do not purport to contain all the information that each Bidder may require. Each prospective Bidder should conduct its own investigations and analysis and check the accuracy, reliability and completeness of the information provided in this Tender document and obtain independent advice from appropriate sources.
3. IWAI will not have any liability to any prospective Company / Firm or any other person under any law (including without limitation the law of contract, tort), the principles of equity, restitution or unjust enrichment or otherwise for any loss, expense or damage which may arise from or be incurred or suffered in connection with anything contained in this Tender document, any matter deemed to form part of this Tender document, the award of the Assignment, the information and any other information supplied by or on behalf of IWAI or their employees, any Contractors or otherwise arising in any way from the selection process for the Assignment. IWAI will also not be liable in any manner whether resulting from negligence or otherwise however caused arising from reliance of any Bidder upon any statements contained in this Tender.
4. IWAI will not be responsible for any delay in receiving the Bids. The issue of this Tender does not imply that IWAI is bound to select a Bidder or to appoint the successful Bidder, as the case may be, for Works and IWAI reserves the right to accept / reject any or all of Bids submitted in response to this Tender document at any stage without assigning any reasons whatsoever. IWAI also reserves the right to withhold or withdraw the process at any stage with intimation to all who submitted the Tender Bids.
5. The information given is not an exhaustive account of statutory requirements and should not be regarded as a complete or authoritative statement of law. IWAI accepts no responsibility for the accuracy or otherwise for any interpretation or opinion on the law expressed herein.
6. IWAI reserves the right to change / modify / amend any or all provisions of this Tender document. Such revisions to the Tender / amended Tender will be made available on the website of IWAI.

Table of Contents

Sl. No.	Details	Page no.
1.	BID DATA SHEET for Key Dates and Check List	4 – 5
2.	Tender issue letter	6
3.	Notice Inviting Tender	7 – 9
	Part-I	10
4 (i)	Tender Acceptance Letter	11
4 (ii)	Form of Tender	12 – 13
5.	Instruction to bidders (ITB) for submission of bid	14 – 25
	Part-II	26
6.	General Conditions	
	(i). Integrity Pact	27 – 31
	(ii). Schedules	32 – 34
	(iii). General conditions of contract	35 – 64
	Part-III	65
7.	Technical Specifications & Special Conditions of Contract	66 - 67
	Part-IV	
	Drawings and Annexures	68
8.	Enclosure-1 Index Map of West Coast Canal Enclosure-2 Cross sections of fenders Annexure-1 Self Declaration of the bidder Annexure-2 Details of Past Experience of Contractor for Similar works / Marine works Annexure-3 Agreement Format Annexure-4 Sample Form for Site Orders Book Annexure-5 Proforma for Hindrance Register Annexure-6 Notice for Appointment of Arbitrator	69 – 78
	Part-V	79
	Schedule of Quantities / Financial Bid	80 & 81

BID DATA SHEET FOR KEY DATES AND CHECK LIST

Particulars	Description
Employer	The Chairman, Inland Waterways Authority of India (IWAI), A-13, Sector-1, Noida-201301
Method of Selection	Least Cost System (LCS) selection method
Name of the Work	Providing & fixing of rubber fenders and replacement of damaged/rusted chains and plates fitted with rubber fenders at various IWAI terminals
a) Closing date for submission of Online Bid and	Date : 05.07.2024 Time : 15:00 Hrs (IST) Submission : Online submission
b) Address for submission of hard copy of POA & payment instruments (Tender Fee & EMD)	The Director, Inland Waterways Authority of India, National Waterway Road, Kannadikkadu, Maradu P.O, Ernakulam, Kerala. PIN 682304
Pre bid meeting	Date: 27.6.2024 at 11.00 AM
Estimated cost of the work	INR 55.61 lakhs. (excl. GST & but incl. Labour welfare Cess)
EMD	INR 1,11,213/-
Tender Fee	INR 5000/-
Mode of Transaction	EMD & Tender fee for the amount mentioned above shall be deposited to IWAI Fund through NEFT / RTGS in the following account: Account No. : 39360627884 Name of Account: Inland Waterways Authority of India Name of the bank: State Bank of India, Vytilla Branch IFSC CODE : SBIN0008694
Minimum Bank Solvency	40% of the estimated cost of this work i.e. Rs. 22.24 lakh.
Bid Validity Period	90 days after last date of Bid Submission
Similar works / Marine works	“Similar works / Marine works ” means namely fixing of rubber fenders, replacement of damaged/rusted chains and plates fitted with rubber fenders with satisfactory performance.
Authorized Representative	Name: Director, IWAI, Kochi
Contract Duration	06 months.
Bid Opening date	Date : 06.07.2024 Time : 15:30 hrs
Document required for technical bid Evaluation.	1. Scanned copy of UTR no of payment towards tender cost and EMD or exemption document proof. 2. Bank solvency with issuing bank authority for verification

Particulars	Description
	<ol style="list-style-type: none"> 3. Tender acceptance letter on letter head with scanned tender document with seal and signature 4. Duly signed tender form and Self Declaration for undertaking for not blacklisted from any department. 5. Copy of valid Registration certificate. 6. Audit report, balance sheet, Financial turn over & IT return for last 3 years (2020-21, 2021-22 & 2022-23) 7. PAN and GST registration copy 8. Prequalification work experience document (Work order & Completion Certificate). 9. Local office and establishment details. 10. Authorisation letter for bidding, negotiation, signing of agreement and execution work (as the case may be)
Location of Assignment	Various IWAI terminals Under IWAI Kochi.
Price Preference	Since Splitting of scope / quantity of work is not feasible keeping in view the nature of work involved, price preference clause for MSME registered firms / bidders will not be applicable.
Performance Guarantee	5% of the quoted amount in the form of NEFT / RTGS mode payment.
Security Deposit	5% as Performance Guarantee, 2% EMD and balance 3% of quoted amount shall be deducted from Running Account Bills in terms of the General Conditions of Contract.
Time schedule	<ul style="list-style-type: none"> • Remittance of Performance security with 15 days from date of issue of LOA • Signing of agreement with 15 days from date of issue of LOA • Work will be completed as per specifications within 01 month from the date of issue of Work order.
Make in India	As per policy of Govt. of India to encourage “Make in India” policy: As per the policy of Government of India to promote the provisions vide order No. P-4502/2/82017-B.E.,-II dated 15.06.2017 as amended by Order No. P-45021/2/2017-B.E-II dated 28.05.2018 and Order No. P-45021/2/ 2017-B.E.-II dated 29.05.2019, have issued the revised “Public Procurement (preference to Make in India) Order 2017” dated 04.06.2020 of Ministry of Commerce and Industry, Department for Promotion of Industry and Internal Trade (Public procurement Section), on the subject “public procurement (preference to Make in India) shall be applicable to the extent possible.



**INLAND WATERWAYS AUTHORITY OF INDIA,
National Waterway Road, Kannadikkadu,
Maradu P.O, NH 47 Bypass,
Ernakulam, Kerala.
PIN: 682 304.**

Websites: www.iwai.nic.in and <https://eprocure.gov.in/eprocure/app>.

TENDER NO. IWAI/COCH/FEN/59/2024-25/32

To,

.....
.....
.....
.....

Sub: Providing & fixing of rubber fenders and replacement of damaged/rusted chains and plates fitted with rubber fenders in various IWAI terminals

Ref: Your letter no....., Dated:

Sir,

With reference to your letter cited above on the subject, please find enclosed herewith one set of tender document for the subject work. You are requested to go through the terms and conditions carefully and also visit the site to familiarise and submit your tender as per procedure explained therein.

The tender document can be downloaded from the IWAI's website www.iwai.nic.in and CPP Portal Website <https://eprocure.gov.in/eprocure/app>. The last date for submission of e- tender is on 05.07.2024 up to 3.00 PM. The Bids will be placed only online at <https://eprocure.gov.in/eprocure/app>. Issuance of tender document will not construe that such bidders are automatically considered qualified.

Yours faithfully

Director.

(For publication in News Paper)



INLAND WATERWAYS AUTHORITY OF INDIA
(Ministry of port, Shipping & Waterways, Govt. of India)
National Waterway Road,
Kannadikkadu, Maradu, Kochi – 682 304.
Ph. 0484 – 2389804 & 0484 - 2389445

Notice Inviting Tender

(Tender No. IWAI/COCH/FEN/59/2024-25/32)

Name of work: Providing & fixing of rubber fenders and replacement of damaged/rusted chains and plates fitted with rubber fenders at various IWAI terminals. Downloading of Tender from 11.00 hrs on 18.6.2024 to 15.00 hrs on 5.7.2024. Estimated Cost: Rs. 55.61 lakhs excluding GST. Pre bid meeting on 27.6.2024 at 11.00 AM. Last date of Submission of e-Tender: 5.7.2024 up to 15.00 Hours. Date of Opening 6.7.2024 at 15.30 Hours. Details of the tender available in IWAI website at www.iwai.nic.in and <https://eprocure.gov.in/eprocure/app>. Further amendments / Corrigendum if any, will be uploaded in above websites only. Bidders are advised to check the website before submitting the tender.

Director

**INLAND WATERWAYS AUTHORITY OF INDIA,
National Waterway Road, Kannadikkadu, Maradu P.O,
Ernakulam, Kerala. PIN: 682 304.**

Websites: www.iwai.nic.in and <https://eprocure.gov.in/eprocure/app>.

Tender Notice No: TENDER NO. IWAI/COCH/FEN/59/2024-25/32

1. Name of Work: Providing & fixing of rubber fenders and replacement of damaged/rusted chains and plates fitted with rubber fenders in various IWAI terminals
2. Inland Waterways Authority of India (IWAI) invites e-tenders in two cover system (Cover I - Technical bid and Cover II - Financial Bid) from experienced and resourceful Contractors for the work of Providing & fixing of rubber fenders and replacement of damaged/rusted chains and plates fitted with rubber fenders in various IWAI terminals
3. Estimated Cost of the work is as under:

Sl. No.	Name of the work	Estimated Cost (Rs. in Lakh)	EMD (in Rs)	Duration of work
1.	Providing & fixing of rubber fenders and replacement of damaged/rusted chains and plates fitted with rubber fenders in various IWAI terminals	Rs.55.61 Lakh. (Exclusive of GST but inclusive of Labour Welfare Cess @ 1%)	1,11,213/-	06 month.

4. Download of tender document: from 11.00 hrs on 18.6.2024 to 15.00 hrs on 05.07.2024.
5. Bid submission closing: 15.00 hrs on 05.07.2024.
6. Pre bid meeting on 27.6.2024 at 11.00 AM
7. Bid Opening Date & Time: 06.07.2024 at 15.30 hrs.

TERMS & CONDITIONS:-

8. The tender document can be downloaded from the IWAI's website www.iwai.nic.in and CPP Portal Website <https://eprocure.gov.in/eprocure/app>. Bidders participating e-tender process are required to furnish a non-refundable deposit of Rs. 5000/- (Rupees Five thousand only) inclusive of 18% GST & through RTGS in the following bank particulars and submitted the proof along with UTR No. towards the remittance of payment of tender cost and upload a copy of the same in Technical Bid, on or before the last date and time of submission of tender. However, Micro and Small Enterprises (MSEs) as defined in MSE Procurement Policy issued by Department of Micro, Small and Medium Enterprises (MSME) or Start-ups as recognized by Department of Industrial Policy & Promotion (DIPP) are exempt from submitting the Tender Fee / cost of Tender document, on submission of documents to the extent as per the Government of India notifications in this regard.

The details of Bank Particulars of IWAI are;

Name of Account Holder : Inland Waterways Authority of India.
Name of Bank & Branch : State Bank of India, Vyttila Branch.
Account No. : 39360627884
IFS Code : SBIN0008694

9. The Bids are to be submitted only online at <https://eprocure.gov.in/eprocure/app>.
10. The tenderer shall meet the following criteria:
- i. The tenderer shall be registered in appropriate class with CPWD, Railways, MES, State PWD / Irrigation Department, Port Trust etc., or shall have required experience in similar type of works on shore structure with satisfactory performance.
 - ii. Tenderer shall have Permanent Account Number issued by Income Tax Dept. and must be an assessee.
 - iii. Average annual financial turnover during last three years ending 31st March of the previous financial year should be at least 100% of the estimated cost. Experience of having successfully completed similar works / Marine works during last 7 years ending last day of month previous to the one in which this tender is invited should be either of following :
 - a. Three similar works / Marine works costing not less than 40% of the estimated cost; or
 - b. Two similar works / Marine works costing not less than 60% of the estimated cost; or
 - c. One similar work completed not less than 80% of the estimated cost

AND

One completed work costing not less than the amount equal to 40% of the estimated cost put to tender with some Central Government Department/State Government Department/ Central Autonomous Body/ State Autonomous Body/ Central Public Sector Undertaking/ State Public Sector Undertaking/City Development Authority/ Municipal Corporation of City formed under any Act by Central/ State Government and published in Central/State Gazette.

Note: The successful completion of the similar work should be supported with a completion certificate issued by the department/ agency for whom the work has been executed.
 - iv. Latest certificate of solvency from Nationalized / Scheduled Bank included in the Second Schedule of the RBI Act for not less than 40% (i.e., for Rs. 22.24lakhs) of the estimated cost of the work.
 - v. Average annual financial turnover on contract works should be at least 100% of the estimated cost during the immediate last 3 consecutive financial years and should not have incurred any loss in more than two years during the last five years ending March of the previous financial year.
 - vi. The tenderer shall furnish the Tender Cost and Earnest Money Deposit through RTGS (in IWAI Account) before closing date and time of submission of tender. Any / all submissions made without the Earnest Money Deposit and without the Tender Cost and / or received after the closing date mentioned shall be rejected.
 - vii. Tender cost and EMD are exempted for SSI units or MSEs registered with Central Purchase Organization or the concerned Ministry or Department or Start-ups as recognized by Department of Industrial Policy & Promotion (DIPP) & copies of same shall be uploaded to avail benefit of exemption.
10. IWAI reserves the right to accept or reject any or all tenders fully & split the work without assigning any reason and no correspondence shall be entertained in this regard.

Director

PART – I

4. (i) Tender Acceptance Letter
- (ii) Form of Tender

5. Instruction to Bidders for submission of bid

PART-I

4 (i) TENDER ACCEPTANCE LETTER (To be given on Company Letter Head)

Date:

To,

The Director,
Inland Waterways Authority of India,
National Waterway Road, Kannadikkadu,
Maradu P.O, NH 47 Bypass,
Ernakulam, Kerala. PIN: 682 304.

Sub: Acceptance of Terms & Conditions of Tender.

Tender Reference No. IWAI/COCH/FEN/59/2024-25/32

Name of Tender/ Work: Providing & fixing of rubber fenders and replacement of damaged/rusted chains and plates fitted with rubber fenders in various IWAI terminals

Dear Sir,

1. I / We have downloaded / obtained the tender document(s) for the above mentioned 'Tender/Work' from the web site(s) namely: www.iwai.nic.in OR https://eprocure.gov.in/eprocure/app as per your advertisement, given in the above mentioned website(s).
2. I / We hereby certify that I / we have read the entire terms and conditions of the tender documents from Page No. _____ to _____ (including all documents like annexure(s), schedule(s), etc.), which form part of the contract agreement and I / we shall abide hereby by the terms / conditions / clauses contained therein.
3. I / We hereby unconditionally accept the tender conditions of above-mentioned tender document(s) / minutes of the pre-bid meeting/ corrigendum(s) in its totality / entirety.
4. In case any provisions of this tender are found violated, then your department/ organisation shall without prejudice to any other right or remedy be at liberty to reject this tender/bid including the forfeiture of the full said earnest money deposit absolutely.

Yours Faithfully,

(Signature of the Bidder, with Official Seal)

4 (ii). FORM OF TENDER

To,

The Director,
Inland Waterways Authority of India
National Waterway Road, Kannadikkadu,
Maradu P.O, NH 47 Bypass,
Ernakulam, Kerala. PIN: 682 304.

Name of Work: Providing & fixing of rubber fenders and replacement of damaged/rusted chains and plates fitted with rubber fenders in various IWAI terminals

Sir,

1. Having visited the site and examined the information and instruction for submission of tender, general conditions of contract, Special Condition of contract, Technical, General and Detailed specification, Schedules and Bill of Quantities, agreement and bank guarantee forms, etc. for the above named works, I/ We hereby tender for execution of the work referred to in the tender document in conformity with the said Conditions of Contract, Specifications, Schedule of quantities for the sum as stated in Bill of quantities of this tender Document or such other sum as may be ascertained in accordance with the said conditions of contract.
2. I/ We undertake to complete and Deliver the whole of the works comprised in the Contract within the time as stated in the tender and also in accordance in all respects with the specifications, designs, drawings and instructions as mentioned in the tender documents.
3. We are registered SSI units / MSEs registered with Central Purchase Organization / the concerned Ministry / Department / Start-ups as recognized by Department of Industrial Policy & Promotion (DIPP) and Tender fees is exempted for submission of tender cost and EMD. Copies of same are also uploaded to avail benefit of exemption.

OR

I am tendering for the work mentioned in the table below duly furnishing Earnest Money Deposit (EMD) of Rs. 1,11,213/- through RTGS in the following bank particulars.

Name of Account Holder : Inland Waterways Authority of India.
Name of Bank & Branch : State Bank of India, Vyttila Branch.
Account No. : 39360627884
IFS Code : SBIN0008694

Sl. No.	Name of the work	Details of amount remitted	Particulars of RTGS transfer along with UTR No.	Name of the Bank
1	Providing & fixing of rubber fenders and replacement of damaged/rusted chains and plates fitted with rubber fenders in various IWAI terminals	EMD (Rs. 1,11,213/-)		

4. I/ We agree to abide by this tender. I/ We agree to keep the tender open for a period of 90 days from the last date of submission of bid or extension thereto as required by the IWAI and not to make any modifications in its term and conditions.
5. I/ We agree, if I/ we fail to keep the validity of the tender open as aforesaid or I/ we make any modifications in the terms and conditions of my/ our tender if I/ We fail to commence the

execution of the works as above, I/ We shall become liable for forfeiture of my/ our Earnest money, as aforesaid and IWAI shall without any prejudice to any other right or remedy, be at the liberty to forfeit the said Earnest Money absolutely otherwise the said earnest money shall be retained by IWAI towards part of security deposit to execute all the works referred to in the tender documents upon the terms and conditions contained or referred to therein and to carry out such deviations as may be ordered. Should this tender be accepted, I/ We agree to abide by and fulfil all the terms and conditions and provisions of this tender. No interest is payable on earnest money deposit and/ or security deposit.

6. I/ We have independently considered the amount of Liquidated Damages shown in the tender hereto and agree that it represents a fair estimate of the loss likely to be suffered by IWAI in the event of works not being completed in time.
7. If this tender is accepted, I/ We undertake to enter into execute at my/ our cost when called upon by the employer to do so, a contract agreement in the prescribed form. Unless and until a formal Agreement is prepared and executed this tender together with your written acceptance thereto shall constitute a binding contract.
8. If my/ our tender is accepted, I/We am/are to be jointly and severally responsible for the due performance of the Contract. I/We also declare that the firm has not been banned or blacklisted by any Govt. or its department or any Quasi Govt. agency or Public Sector Undertaking or Multilateral or International Aid Agency/Development Bank.
9. I/ We understand that you are not bound to accept the lowest or any tender you may receive and may reject all or any tender without assigning any reason.
10. I/ We certify that the tender submitted by me, us is strictly in accordance with the terms, conditions, specifications etc. as contained in the tender document, and it is further certified that it does not contain any deviation to the aforesaid documents.

Date

Signature

Name

Designation

duly authorized to sign & submit tender for an on behalf of
(Name and address of firm)

M/s

.....

Telephone nos.....FAX No.....

Witness :

Signature.....

Name :

Occupation

AddressTelephone nos.

5. INSTRUCTIONS TO BIDDERS FOR SUBMISSION OF BID

- 1.0** All covering letters and information to be included in the bid shall be submitted along with the bid itself.
- 2.0** This tender schedule is only for the work of Providing & fixing of rubber fenders and replacement of damaged/rusted chains and plates fitted with rubber fenders in various IWAI terminals
- 3.0** The total estimated cost of works is Rs. 55.61 lakhs exclusive of GST.
- 4.0** Tender should be submitted online at <https://eprocure.gov.in/eprocure/app> latest by 15.00 hours on 05.07.2024 **in two bid systems i.e.,** Technical Bid and Price Bid. Technical Bid of the offer will be opened online at 15:30 hours on 06.07.2024 at IWAI, Kannadikkadu, Maradu, Ernakulam, Kerala.

4.1. Technical Bid

The technical bid shall be submitted online along with scanned copy of the following documents:

- a) Scanned copy of the 'Tender Acceptance Letter' duly signed and stamped.
- b) Scanned copy of the 'Form of Tender' duly signed and stamped.
- c) Scanned copy of the 'Tender document' duly signed and stamped
- d) Scanned copy of Self Declaration in the form as **Annex-1** on page no. 71 to be submitted in letter head of the registered firm.
- e) Scanned copy of Payment Receipt made through RTGS (along with UTR No.) towards cost of the bidding documents must be uploaded. A certified copy of Payment Receipt is to be deposited in the office before the bid submission closing date & time.

Tender fee is exempted for SSI units or MSEs registered with Central Purchase Organization or the concerned Ministry or Department or Start-ups as recognized by Department of Industrial Policy & Promotion (DIPP). Copies of the applicable credential shall be submitted to avail benefit of exemption.

- f) Scanned copy of Payment Receipt made through RTGS (along with UTR No.) towards remittance of Earnest Money Deposit must be uploaded. A certified copy of Payment Receipt is to be deposited in the office before the bid submission closing date & time.

Earnest Money Deposit is exempted for SSI units or MSEs registered with Central Purchase organization or the concerned Ministry or Department or Start-ups as recognized by Department of Industrial Policy & Promotion (DIPP). Copies of the applicable credential shall be submitted to avail benefit of exemption.

- g) Registration certificate from concerned Authorities.
- h) Details of experience in the form at **Annex-2** on page no. 72 (please read foot note also) and copies of experience certificate. (Experience certificate for the works of similar nature with satisfactory performance).
- i) Latest Solvency certificate for not less than Rs. 22.24 lakhs issued by Nationalised / Scheduled Bank, which should not be older than 6 months from the last date of bid submission. The Solvency Certificate should have full address of banker for confirmation.
- j) Letter of Authority for signing and negotiation of tender (as the case may be).
- k) Duly signed Integrity Pact (given in Part-II, General conditions)

- l) Permanent Account Number (PAN) issued by Income Tax Department.
- m) Audited balance sheets of profit and loss account / copies of Annual Turnover for the last 3 years i.e. ending March 2021, 2022 and 2023.
- n) Goods & Services Tax Registration number including copy of registration certificate.

The technical bid shall not contain any reference on price bid or quoted price of the bidder offer. Such bids will be treated as technically disqualified and their price will not be opened.

4.2. Price Bid

The price bid shall be submitted online for

- (i) Schedule of Prices duly filled in the specified form.
- (ii) This part shall not contain any terms & conditions. Any condition given in the price bid will be a sufficient cause for rejection of bid.

5.0 Bidders are advised to submit their offer strictly based upon technical specification, terms and conditions contained in documents and not to stipulate any deviations. Any change in this may lead to rejection of bid.

6.0 Earnest Money Deposit of Rs. 1,11,213/- for the tendered work in Notice Inviting Tender should be submitted through RTGS in the A/c. No. 39360627884 of Inland Waterways Authority of India, maintained at State Bank of India, Vytilla Branch (IFS Code: SBIN0008694).

A certified copy of Payment Receipts towards Tender Cost and Earnest Money Deposit shall be submitted in the office of IWAI, National Waterway Road, Kannadikkadu, Maradu P.O, NH 47 Bypass, Ernakulam, Kerala, PIN 682 304 on or before the closing date & time of submission of bid. In case the EMD & Tender fee does not credited in the specified Account No. of IWAI due to any reasons, the bid is liable for rejection.

The Earnest Money of the Successful Bidder submitted through RTGS mode will be retained as Security Deposit.

The Bid Security / Earnest Money will be forfeited if the Bidder withdraws the Bid after its submission during the period of Bid Validity or in the case of a Successful Bidder, if the Bidder fails within the specified time limit to sign the Agreement; and/or to furnish the required Performance Security.

6.1 All Bidders shall furnish EMD of the amount as mentioned in Section III: Bid Data Sheet. However, Micro and Small Enterprises (MSEs) as defined in MSE Procurement Policy issued by Department of Micro, Small and Medium Enterprises (MSME) or Start-ups as recognized by Department of Industrial Policy & Promotion (DIPP) are exempt from submitting the EMD on submission of documents to the extent as per the Government of India notifications in this regard.

Bids not accompanied by EMD shall be rejected as non-responsive.

No interest shall be payable by the Employer for the sum deposited as EMD.

The EMD of those Bidders whose Financial Bids have been opened but are not selected as "Successful Bidder" would be returned within seven (7) days of issuance of LoA to the successful Bidder.

The EMD of Bidders who have not qualified for opening of Price Bids would be returned within seven (7) days of opening of Price bid.

The EMD shall be forfeited by the Employer in the following events:

- i. If Bid is withdrawn during the bid validity period including any extension agreed to by the Bidder thereof.
- ii. If the Bidder tries to influence the evaluation process.
- iii. If the lowest Bidder raises any fresh issue and / or T&C during negotiations, it will be construed as withdrawal of the original bid and in that case EMD is liable to be forfeited.
- iv. In case the Bidder, submits false certificate in terms of any documents supported to this Tender.
- v. If the Bidder fails to sign the contract in accordance with Conditions of Contract on receipt of LoA.
- vi. In case the Bidder is found to indulge in corrupt or fraudulent practices at any stage of the execution of the contract.
- vii. If the Bidder fails to furnish the Performance Bank Guarantee in accordance with Conditions of Contract.
- viii. In case of a Bidder revoking or withdrawing his Tender or varying any terms of the Bid without the consent of the Employer in writing.
- ix. In case of forfeiture of EMD, as prescribed from (i) to (viii) above, the Bidder shall not be allowed to participate in the retendering process of the work.

6.2 Cost of Tender Document / Tender Fee

All Bidders are required to pay the cost of Tender Document as mentioned in Section I: Bid Data Sheet, through RTGS / NEFT. However, Micro and Small Enterprises (MSEs) as defined in MSE Procurement Policy issued by Department of Micro, Small and Medium Enterprises (MSME) or Start-ups as recognized by Department of Industrial Policy & Promotion (DIPP) are exempt from submitting the Tender fee on submission of documents to the extent as per the Government of India notifications in this regard. The cost of Tender Document is Non-Refundable.

6.3 Bank Solvency

All Bidders shall submit Bank Solvency certificate from a nationalized / scheduled bank in India for a minimum amount as mentioned in Bid Data Sheet. The bank solvency certificate submitted by the Bidder shall not be older than six (6) months from the Bid Submission Last Date. **In case Bidder does not adhere to this criterion, his bids shall be considered non-responsive and shall not be considered for further evaluation process.**

6.4 Taxes

The Bidders shall fully familiarize themselves with the applicability of all types of taxes and all such taxes, as prevailing on date of submission of the bid, must be included by the Bidder in the Financial Proposal along with the conditions mentioned therein, except for GST which will be claimed separately along with the RA Bills. It may be noted that the Bidder shall have to be registered with GST and shall submit the proof of the same at the time of bid submission. The GST and all other relevant taxes shall be paid as per existing rules and regulations at the time of payment.

- 7.0 Any annotations or accompanying documentation in the bid shall be in Hindi or English language only and in metric system. Tenders filled in any other language will be summarily rejected.
- 8.0** Bidders shall sign their proposal with the exact name of the firm to whom the bid document has been issued / downloaded. The bid shall be duly signed and sealed by an authorized person of the bidder's organization as following:
- 8 (a) If the Tender is submitted by an individual, it shall be signed by the proprietor above his full name and full name of his firm with its current business address.
- 8 (b) If the Tender is submitted by the proprietary firm, it shall be signed by the proprietor above his full name and full name of his firm with its name and current business address.
- 8 (c) If the Tender is submitted by a firm in partnership, it shall be signed by all the partners of the firm above, their full names and current business address, or by a partner holding the power of attorney for the firm for signing the Tender in which cases a certified copy of the power of attorney shall accompany the Tender. A certified copy of the partnership deed and current business address of all the partners of the firm shall also accompany the Tender.
- 8 (d) If the Tender is submitted by a limited company, or a limited Corporation, it shall be signed by a duly authorized person holding the power of attorney for signing the tender in which case a certified copy of the power of attorney shall accompany the Tender. Such limited company or corporation may be required to furnish satisfactory evidence of its existence before the contract is awarded. 'Satisfactory evidence' means the certificate of incorporation of the limited company or corporation under Indian Companies Act, 1956.
- 8 (e) All witnesses and sureties shall be persons of status and their full names, occupations and addresses shall be stated below their signatures. All signatures affixed in each page in the tender will be dated.
- 9.0** Bidders shall clearly indicate their legal constitution and the person signing the tender shall state his capacity and also the source of his ability to bind the bidder. The power of attorney or authorization or any other document constituting adequate proof of the ability of the signatory to bind the bidder shall be annexed to the bid. The Owner may reject outright any bid unsupported by adequate proof of the signatory's authority.
- 10.0** The bid document shall be completed in all respects and shall be submitted together with the requisite information and appendices. They shall be complete and free from ambiguity, change or inter-lineation. In case IWAI requires any information/ clarification(s) from the Bidder in respect of the bid documents, the bidder shall be required to furnish the same in writing, to IWAI at the earliest where no time is specified by IWAI to furnish the same. A failure to furnish the same shall entitle IWAI to cancel/ reject the bid.
- 11.0** If the space in the bid form or in the Appendices thereto is insufficient, additional pages shall be separately added. These pages shall be consecutively page numbered and shall also be signed by the Bidder.
- 12.0** Bidders should indicate at the time of quoting against this bid their full postal addresses, telephone numbers and other communication details enabling IWAI to contact the bidder in case the need so arise.
- 13.0** IWAI shall have an unqualified option under the said bid bond to claim the amount there under in the event of the Bidder failing to keep the bid valid up to the date specified or refusing to accept work or carry it out in accordance with the bid if the IWAI decides to award the Work to the Bidder.

- 14.0 The EMD shall be retained with the IWAI until finalization of tenders. Further, security deposit as per the Clause of Security shall be payable by the successful bidder. If the tenderer fails to furnish the security deposit in accordance with tender conditions EMD shall be forfeited. In the event of the Bidder becoming the successful Contractor, the amount of EMD would be adjusted against the Security deposit.
- 15.1 The earnest money deposit (EMD) submitted by all the bidders except the lowest bidder shall be refunded immediately latest within a week from the date of approval of the award of the contract to the lowest bidder (s)/decision to re-tender or otherwise closure of the proposal as the case may be, by the competent authority. No interest shall be payable on EMD by IWAI.
- 15.2 In case of Joint Venture (JV), only Lead Partner can deposit EMD and same will be refunded to the bank account of the Lead Partner provided by the bidders / tenderers in the bid.
- 15.3 In case, where the Office-In-Charge considers that an item of EMD instead of being refunded, be carried to the credit of the IWAI-Fund, then the fact required to be recorded on the Deposit Receipt with the Officers initial records, and request the Accounts / Finance Wing to effect necessary adjustment in Accounts. Accordingly, the concerned bidders shall be communicated this fact within the period specified for EMD refund.
- 16.0 The Tender Evaluation Committee (TEC) shall open the tenders in the presence of the intending tenderers who may be present at the date and time of opening informed in the bid document or subsequently. If any of the tenderer or his agent is not present at the time of opening of tender, the TEC shall, on opening of tenders of the absentee tenderer, prepare a statement of the attested and unattested corrections in the tender over their signature. Such a list shall then be binding on the absentee tenderer.
- 17.0 The successful tenderers shall be required to execute a contract agreement in the given format. In case of any refusal/ failure on the part of such successful tenderer to execute such a contract shall be deemed to be a failure on the part of such successful bidder to comply with the terms contained herein.

18.0 Qualification of the Bidder

- 18.1 This invitation for online bids is open to all reputed and resourceful contractors fulfilling the criteria given under Terms and Conditions in the Tender Notice and as regards the size / value of experience in execution of similar works / Marine works during past seven years, the factor specified below shall be used to bring the value of such completed works at the level of current financial year i.e. FY 2023-24.

Year Before	Multiplying Factor
One	1.07
Two	1.14
Three	1.21
Four	1.28
Five	1.35
Six	1.42
Seven	1.49

- 19.0 Each Bidder shall submit only one online Bid for the work. A Bidder who submits more than one Bid will cause proposals with the Bidder's participation to be disqualified.
- 20.0 The Bidder shall bear all costs associated with the preparation and submission of his Bid, and the Owner will, in no case, be responsible or liable for those costs regardless of the conduct or outcome of the bidding process.

21.0 The bidder is expected to examine carefully all instructions, conditions of contract, contract data, terms, specifications, forms and drawings in the Bid Document. Failure to comply with the requirements of Bid Documents shall be at the bidder's own risk. Pursuant to clause 33 hereof, bids, which are not substantially responsive to the requirements of the Bid Documents, shall be rejected.

22.0 Clarification of Bidding Documents

22.1 A prospective Bidder requiring any clarification of the bidding documents may notify the Tender Inviting Authority in writing, by facsimile or email at the address indicated in the Tender Notice / Notice Inviting Tender. The tender inviting authority will respond to any request for clarification received earlier than 7 days prior to the deadline for submission of bids. Copies of the response will be forwarded to all purchasers of the bidding documents / will be uploaded to the web sites, including a description of the inquiry, but without identifying its source.

23.0 Amendment of Bidding Documents:

Before the deadline for online submission of bids, the Owner may modify/amend/make addition in the bidding documents for any reason, whether at its own initiative or in response to clarification requested by a prospective bidder by issuing addenda/corrigendum. Any addendum/corrigendum/ minutes of pre bid meeting uploaded on website shall be part of the bidding documents. Corrigendum / Addendum/ Minutes of pre bid meeting will be available on website. The modification /amendment/ additions in the bidding document shall be binding on the prospective bidders. To give prospective bidders reasonable time in which to take a corrigendum / addendum / minutes of pre bid meeting into account in preparing their bids, the Owner may extend, as necessary, the deadline for submission of bids.

24.0 Bid Prices:

The Contract shall be for the whole Works, as described, based on the cost schedule submitted by the Bidder. The bidder shall quote rates and prices for all items of the Works described in the cost schedule. The prices shall include all the taxes, levies, cess, royalty, terminal tax, or any other local, State or Central taxes as applicable / charged by Central or State Government or Local authorities on all materials that the contractor has to purchase for the performance of the contract and services and the Authority will not entertain any claim for compensation whatsoever in this regard. The rates quoted by the bidder shall be deemed to be inclusive of all such taxes, duties, cess, levies, etc. including 1% Labour Welfare Cess except for GST which shall be indicated and claimed separately. Labour Welfare Cess @ 1% of the value of the contract shall be deducted from the RA bills of the Contractor and deposited by IWAI as per norms of Govt. of India.

Bidders are to download BOQ through <https://eprocure.gov.in/eprocure/app> and cannot modify BOQ, they can enter only white portion of BOQ. The Bidder shall quote rate for Per item Basic price, inclusive of Freight, Insurance, Transportation, packing, Inspection if applicable etc. The GST has to be mentioned separately

Prices quoted by the Bidder shall remain firm and fixed and valid till the validity time. The prices quoted shall be for destination of the consignees.

Form No. 'C' or 'D' & 31/32 will not be issued by the "Authority". Road permit, way bill etc. are to be arranged by the Bidder.

The rates and prices quoted by the Bidder shall be fixed for the duration of the Contract and shall not be subject to adjustment. The prices shall be quoted by the bidder entirely in Indian Rupees. All payments shall be made in Indian Rupees.

25.0 Bid Validity: Bids shall remain valid for a period of 90 days after the last date for bid submission. A bid valid for a shorter period will be treated as non-responsive and shall be rejected.

In exceptional circumstances, prior to expiry of the original time limit, the IWAI may request the bidder to extend the period of validity for a specified additional period. The request and the bidders' responses shall be made in writing. A bidder may refuse the request without forfeiting his bid security. A bidder agreeing to the request will not be required or permitted to modify his bid, but will be required to extend the validity of his bid security.

26.0 Bidder shall submit offers that fully comply with the requirement of the bidding document including conditions of contract. Conditional offer or alternate offer will not be considered in the process of tender evaluation.

27.0 The Bidder shall submit online bid and the Bid shall be signed by a person or persons duly authorized to sign on behalf of the Bidder. All pages of the Bid shall be signed by the person or persons signing the Bid. The Bid shall contain no overwriting, alterations or additions, except those to comply with instructions issued by the Tender Inviting Authority.

28.0 Submission of Bids: The Bidder shall submit online bids. Complete online Bids (including Technical and Financial) must be received by the bid submission closing date and time. The Tender inviting Authority may extend the deadline for submission of bids by issuing an amendment, in which case all rights and obligations of the Owner and the bidders previously subject to the original deadline will then be subject to the new deadline.

29.0 Modification and Withdrawal of Bids: Bidders may modify or withdraw their bids online before the deadline prescribed. Withdrawal or modification of a Bid between the deadline for submission of bids and the expiration of the original period of bid validity specified or as extended shall result in the forfeiture of the Bid security.

30.0 Bid Opening and Evaluation

30.1 Online Bid opening shall be carried out in two stages. Firstly, 'Technical Bid' of all the online bids received shall be opened on the date and time mentioned. 'Financial Bid' of those bidders whose technical bid has been determined to be responsive and on evaluation fulfils the criteria shall be opened on a subsequent date, which will be notified to such bidders.

30.2 The Owner will open the online "Technical Bid" of all the bids received in the presence of the bidders/bidders' representatives who choose to attend at the time, date and place specified. In the event of the specified date for the submission of bids being declared a holiday for the Owner, the Bids will be opened at next immediate convenient time & date which will be notified through the web site.

30.3 Bidder's names and such other details like EMD furnished, as the Owner may consider appropriate will be announced by the Owner after the opening.

30.4 After the opening of the technical bids, their evaluation will be taken up with respect to bid security, qualification and other information furnished in Technical bid. Thereafter, on fulfilling the criteria laid down in Bid Evaluation, a list will be drawn up of the responsive bids whose financial bids are eligible for consideration.

30.5 The Owner shall inform the bidders, whose technical bids are found responsive, of the date, time and place of opening of the financial bids. The bidders so informed, or their representative, may attend the online opening of financial bids.

30.6 At the time of the online opening of the 'Financial Bid', the names of the bidders whose bids were found responsive and the Bid prices, the total amount of each bid and such other details as the Owner may consider appropriate will be announced by the Owner.

31.0 Process to be Confidential

Information relating to the examination, clarification, evaluation, and comparison of bids and recommendations for the award of a contract shall not be disclosed to bidders or any other persons not officially concerned with such process until the award to the successful Bidder has been announced. Any attempt by a Bidder to influence the Owner's processing of bids or award decisions may result in the rejection of his Bid.

32.0. Clarification of Bids and Contacting the Owner

32.1 During the evaluation of the bids, the owner may, at its discretion, ask the bidder to provide any additional information/clarification in relation to its bids as may be deemed fit by the owner. The bidder shall in all cases where such request has been made by the owner, submit such information/clarification within such period and in such manner as may be specified by the owner in the request so made. In the event of failure of the bidder to furnish such additional information as may be requested by the owner, the owner may, in its sole discretion, deem such bid as non-responsive. The bidder shall not have any right to challenge the same or any claims arising from such bid being deemed non-responsive by the owner.

32.2 No bidder shall contact the owner on any matter relating to its bid from the time of the bid opening to the time the contract is awarded. Any attempt by the bidder to influence the Owner's bid evaluation, bid comparison or contract award decision may result in the rejection of his bid.

33.0 Examination of Bids and Determination of Responsiveness

During the detailed evaluation of "Technical Bids", the Owner will first determine whether each Bid (a) meets the eligibility criteria (b) has been properly signed; (c) is accompanied by the required securities; and (d) is responsive to the requirements of the bidding documents.

After the above process is completed, the technical specification/offer of the responsive bidders will be examined with respect to technical specifications provided in the tender document. Clarifications, if any, at this stage in respect of the technical parameters offered by the bidder will be sought from the bidders. Thereafter, the bids, which conform, to the terms, conditions, and specifications of the bidding documents, without material deviation or reservation will be considered as responsive for evaluation.

34.0 Evaluation of Bids

34.1 Selection of the bidder for the tendered work will be based on technical and financial evaluation.

34.2 Technical evaluation shall be based on the bidder satisfying the eligibility criteria stated in clause 9 of Terms and Conditions under the Tender Notice AND the bidder furnishing all documents / certificates / undertakings as specified in clause 4.1 under INSTRUCTIONS FOR SUBMISSION OF BID.

34.3 Verification of the facts furnished by the bidders may be made prior to finalizing the technical evaluation.

34.4 If the bidder does not fulfil the above criteria his bid shall be technically disqualified and his financial bid shall not be opened.

34.5 The evaluation of the financial bid will be based on the lowest financial offer received for the work.

35.0 Award of Contract

35.1. Subject to Clause 36, the Owner will award the Contract to the Bidder after evaluation as per Clause 34.

35.2. Owner has the right to accept any Bid and to reject any or all Bids and split the work or Increase and Decrease work. Notwithstanding Clause 35.1, the Owner also reserves the right to cancel the bidding process and reject all bids, at any time prior to the award of Contract, without thereby incurring any liability to the affected Bidder or bidders or any obligation to inform the affected Bidder or bidders of the grounds for the Owner's action.

35.3 As per policy of Govt. of India to encourage "Make in India" policy: As per the policy of Government of India to promote the provisions vide order No. P-4502/2/82017-B.E.,-II dated 15.06.2017 as amended by Order No. P-45021/2/2017-B.E-II dated 28.05.2018 and Order No. P-45021/2/ 2017-B.E.-II dated 29.05.2019, have issued the revised "Public Procurement (preference to Make in India) Order 2017" dated 04.06.2020 of Ministry of Commerce and Industry, Department for Promotion of Industry and Internal Trade (Public procurement Section), on the subject "public procurement (preference to Make in India) shall be applicable to the extent possible.

36.0 Notification of Award and Signing of Agreement.

36.1 The bidder whose Bid has been accepted will be notified of the award by the Owner prior to expiration of the Bid validity period and this letter will be called "Letter of Acceptance" or "Work order" which will state the sum that the Owner will pay to the Contractor in consideration of the execution and completion of the Works by the Contractor as prescribed by the Contract (hereinafter and in the Contract called the "Contract Price") and also the time period for completion of the works.

36.2 The notification of award will constitute the formation of the Contract, subject only to the furnishing of a performance security in accordance with the provisions of Clause 37.

36.3 The Agreement will incorporate all agreements between the Owner and the successful Bidder. It will be signed in the proforma given at **Annexure.3** by the Owner and the successful Bidder after the performance security is furnished and within 15 days of issuance of Letter of Acceptance.

36.4 Upon the furnishing of the Performance Security by the successful Bidder, the other Bidders will be informed that their Bids have been unsuccessful.

37.0 Performance Security

37.1 Within 15 (fifteen) days of issue of the Letter of Acceptance, the successful Bidder shall deliver to the Owner a Performance Security equivalent to five percent [5%] of the Contract Price.

37.2 The performance security shall be furnished through RTGS in the A/c. No. 39360627884 of Inland Waterways Authority of India, maintained at State Bank of India, Vyttila Branch (IFS Code: SBIN0008694).

37.3 Failure of the successful bidder to comply with the requirement of sub-clause 37.1 shall constitute sufficient ground for cancellation of the award and forfeiture of the bid security.

38.0 Corrupt or Fraudulent Practices

The Owner will reject a proposal for award if it determines that the Bidder recommended for award has engaged in corrupt or fraudulent practices in competing for the contract in question and will declare the firm ineligible, either indefinitely or for a stated period of time, to be awarded a contract with Inland Waterways Authority of India and any other agencies, if it at any time determines that the firm has engaged in corrupt or fraudulent practices in competing for the contractor, or in execution.

The Owner requires the bidders/Contractors to strictly observe the laws against fraud and corruption enforced in India, namely, Prevention of Corruption Act, 1988.

39.0 Instructions to the Bidders for the submission of bids online through the e-Procurement Portal <https://eprocure.gov.in/eprocure/app>

- 39.1 Possession of valid Digital Signature Certificate (DSC) and enrollment/registration of the consultants/bidders on the e-procurement/e-tender portal is a prerequisite for e-tendering.
- 39.2 Bidder should do the enrollment in the e-Procurement site using the <https://eprocure.gov.in/eprocure/app> option available "Enroll Here" on the home page. Portal. Enrollment is free of charge. During enrollment/registration, the bidders should provide the correct/true information including valid email-id. All the correspondence shall be made directly with the contractors/bidders through email-id provided.
- 39.3 Bidder need to login to the site through their user ID/ password chosen during enrollment/registration.
- 39.4 Then the Digital Signature Certificate (Class II or Class III Certificates with signing key usage) issued by SIFY/TCS/ nCode/ eMudra or any Certifying Authority recognized by CCA India on eToken / Smart Card, should be registered.
- 39.5 The DSC that is registered only, should be used by the bidder and should ensure safety of the same.
- 39.6 Contractor/Bidder may go through the tenders published on the site and download the required tender documents/schedules for the tenders he/she is interested.
- 39.7 After downloading / getting the tender document/schedules, the Bidder should go through them carefully and then submit the documents as asked.
- 39.8 If there are any clarifications, this may be obtained online through the tender site, or through the contact details. Bidder should take into account of the corrigendum published before submitting the bids online.
- 39.9 Bidder then logs in to the site through the secured log in by giving the user id/ password chosen during enrolment/registration and then by giving the password of the eToken/ Smart Card to access DSC.
- 39.10 Bidder selects the tender which he/she is interested in by using the search option and then moves it to the 'my favourites' folder.
- 39.11 From the favourites folder, he selects the tender to view all the details indicated.
- 39.12 It is construed that the bidder has read all the terms and conditions before submitting their offer. Bidder should go through the tender schedules carefully and upload the documents as asked; otherwise, the bid will be rejected.

- 39.13 Bidder, in advance, should get ready the bid documents to be submitted as indicated in the tender document/schedule and generally, they can be in general PDF/xls/rar/jpg formats. If there is more than one document, they can be clubbed together and can be provided in the requested format. Each document to be uploaded through online for the tenders should be less than 2 MB. If any document is more than 2MB, it can be reduced through zip/rar and the same can be uploaded, if permitted.
- 39.14 If there are any clarifications, this may be obtained through the site, or during the pre-bid meeting if any. Bidder should take into account the corrigendum published from time to time before submitting the online.
- 39.15 The Bidders can update well in advance, the documents such as certificates, annual report details etc., under My Space option and these can be selected as per tender requirements and then send along with bid documents during bid submission. This will facilitate the bid submission process faster by reducing upload time of bids.
- 39.16 Bidder should submit the Tender Fee/ EMD as specified in the tender. The original payment instruments should be posted/ couriered/ given in person to the Tender Inviting Authority within the due date as mentioned in this tender document. Scanned copy of the instrument should be uploaded as part of the offer, if asked for.
- 39.17 While submitting the bids online, the bidder reads the terms & conditions and accepts the same to proceed further to submit the bid packets.
- 39.18 The bidder has to select the payment option as offline to pay the Tender FEE/ EMD as applicable and enter details of the instruments.
- 39.19 The details of the DD/any other accepted instrument, physically sent, should tally with the details available in the scanned copy and the data entered during bid submission time. Otherwise submitted bid will not be acceptable.
- 39.20 The bidder has to digitally sign and upload the required bid documents one by one as indicated. Bidders to note that the very act of using DSC for downloading the bids and uploading their offers shall be deemed to be a confirmation that they have read all sections and pages of the bid document including General conditions of contract without any exception and have understood the entire document and are clear about the requirements of the tender requirements.
- 39.21 The bidder has to upload the relevant files required as indicated in the cover content. In case of any irrelevant files, the bid will be rejected.
- 39.22 If the price bid format is provided in a spread sheet file like BoQ_xxxx.xls, the rates offered should be entered in the allotted space only and uploaded after filling the relevant columns. The Price Bid/BOQ template must not be modified/replaced by the bidder, else the bid submitted is liable to be rejected for this tender.
- 39.23 The bidders are requested to submit the bids through online e-tendering system to the Tender Inviting Authority (TIA) well before the bid submission end date & time (as per Server System Clock). The TIA will not be held responsible for any sort of delay or the difficulties faced during the submission of bids online by the bidders at the eleventh hour.
- 39.24 After the bid submission, the acknowledgement number, given by the e-tendering system should be printed by the bidder and kept as a record of evidence for online submission of bid for the particular tender and will also act as an entry pass to participate in the bid opening date.

- 39.25 The bidder should ensure/see that the bid documents submitted should be free from virus and if the documents could not be opened, due to virus, during tender opening, the bid is likely /liable to be rejected.
- 39.26 The time settings fixed in the server side & displayed at the top of the tender site, will be valid for all actions of requesting, bid submission, bid opening etc., in the e-tender system. The bidders should follow this time during bid submission.
- 39.27 All the data being entered by the bidders would be encrypted using PKI encryption techniques to ensure the secrecy of the data. The data entered will not viewable by unauthorized persons during bid submission & not be viewable by any one until the time of bid opening.
- 39.28 Any bid document that is uploaded to the server is subjected to symmetric encryption using a system generated symmetric key. Further this key is subjected to asymmetric encryption using buyers/bid opener's public keys. Overall, the uploaded tender documents become readable only after the tender opening by the authorized bid openers.
- 39.29 The confidentiality of the bids is maintained since the secured Socket Layer 128 bit encryption technology is used. Data storage encryption of sensitive fields is done.
- 39.30 The bidder should logout of the tendering system using the normal logout option available at the top right hand corner and not by selecting the (X) exit option in the browser.
- 39.31 Any queries relating to the tender document and the terms and conditions contained therein should be addressed to the Tender Inviting Authority for a tender or the relevant contact person indicated in the tender.
- 39.32 Any queries relating to the process of online bid submission or queries relating to CPP Portal in general may be directed to the 24x7 CPP Portal Helpdesk. The contact number for the helpdesk is 1800 233 7315.

PART – II

6. GENERAL CONDITIONS.

- (i) Integrity Pact**
- (ii) Schedules**
- (iii) General Conditions of Contract.**

PART – II

To be signed by the bidder and same signatory competent / authorized to sign the relevant contract on behalf of IWAI.

(i) INTEGRITY AGREEMENT

This Integrity Agreement is made at on this day of 20.....

BETWEEN

Chairman / Chairperson, Inland Waterways Authority of India represented through the Director, Inland Waterways Authority of India, National Waterway Road, Kannadikkadu, Maradu P.O, NH 47 Bypass, Ernakulam, Kerala. PIN 682 304.

(Hereinafter referred as the ‘Principal/Owner’, which expression shall unless repugnant to the meaning or context hereof include its successors and permitted assigns)

AND

.....
(Name and Address of the Individual/firm/Company)

through(Hereinafter referred to as the
(Details of duly authorized signatory)

“Bidder/Contractor” and which expression shall unless repugnant to the meaning or context hereof include its successors and permitted assigns)

Preamble

WHEREAS the Principal/ Owner has floated the Tender No. IWAI/COCH/47/2024-25/ (hereinafter referred to as “Tender/Bid”) and intends to award, under laid down organizational procedure, contract for Providing & fixing of rubber fenders and replacement of damaged/rusted chains and plates fitted with rubber fenders in various IWAI terminals

AND WHEREAS the Principal/Owner values full compliance with all relevant laws of the land, rules, regulations, economic use of resources and of fairness/transparency in its relation with its Bidder(s) and Contractor(s).

AND WHEREAS to meet the purpose aforesaid, both the parties have agreed to enter into this Integrity Agreement (hereinafter referred to as “Integrity Pact” or “Pact”), the terms and conditions of which shall also be read as integral part and parcel of the Tender/Bid documents and Contract between the parties.

NOW, THEREFORE, in consideration of mutual covenants contained in this Pact, the parties hereby agree as follows and this Pact witnesses as under:

Article 1: Commitment of the Principal/Owner

- 1) The Principal/Owner commits itself to take all measures necessary to prevent corruption and to observe the following principles:

- (a) No employee of the Principal/Owner, personally or through any of his/her family members, will in connection with the Tender, or the execution of the Contract, demand, take a promise for or accept, for self or third person, any material or immaterial benefit which the person is not legally entitled to.
 - (b) The Principal/Owner will, during the Tender process, treat all Bidder(s) with equity and reason. The Principal/Owner will, in particular, before and during the Tender process, provide to all Bidder(s) the same information and will not provide to any Bidder(s) confidential / additional information through which the Bidder(s) could obtain an advantage in relation to the Tender process or the Contract execution.
 - (c) The Principal/Owner shall endeavour to exclude from the Tender process any person, whose conduct in the past has been of biased nature.
- 2) If the Principal/Owner obtains information on the conduct of any of its employees which is a criminal offence under the Indian Penal code (IPC)/Prevention of Corruption Act, 1988 (PC Act) or is in violation of the principles herein mentioned or if there be a substantive suspicion in this regard, the Principal/Owner will inform the Chief Vigilance Officer and in addition can also initiate disciplinary actions as per its internal laid down policies and procedures.

Article 2: Commitment of the Bidder(s)/Contractor(s)

1. It is required that each Bidder/Contractor (including their respective officers, employees and agents) adhere to the highest ethical standards, and report to the IWAI all suspected acts of fraud or corruption or Coercion or Collusion of which it has knowledge or becomes aware, during the tendering process and throughout the negotiation or award of a contract.
2. The Bidder(s)/Contractor(s) commit himself to take all measures necessary to prevent corruption. He commits himself to observe the following principles during his participation in the Tender process and during the Contract execution:
 - a) The Bidder(s)/Contractor(s) will not, directly or through any other person or firm, offer, promise or give to any of the Principal/Owner's employees involved in the tender process or execution of the contract or to any third person any material or other benefit which he/she is not legally entitled to, in order to obtain in exchange any advantage of any kind whatsoever during the Tender process or during the execution of the contract.
 - b) The Bidder(s)/Contractor(s) will not enter with other Bidder(s) into any undisclosed agreement or understanding, whether formal or informal. This applies in particular to prices, specifications, certifications, subsidiary contracts, submission or non-submission of bids or any other actions to restrict competitiveness or to cartelize in the bidding process.
 - c) The Bidder(s)/Contractor(s) will not commit any offence under the relevant IPC/PC Act. Further the Bidder(s)/Contractor(s) will not use improperly, (for the purpose of competition or personal gain), or pass on to others, any information or documents provided by the Principal/Owner as part of the business relationship, regarding plans, technical proposals and business details, including information contained or transmitted electronically.
 - d) The Bidder(s)/Contractor(s) of foreign origin shall disclose the names and addresses of agents/representatives in India, if any. Similarly, Bidder(s)/Contractor(s) of Indian Nationality shall disclose names and addresses

of foreign agents/representatives, if any. Either the Indian agent on behalf of the foreign principal or the foreign principal directly could bid in a tender but not both. Further, in cases where an agent participates in a tender on behalf of one manufacturer, he shall not be allowed to quote on behalf of another manufacturer along with the first manufacturer in a subsequent/parallel tender for the same item.

- e) The Bidder(s)/Contractor(s) will, when presenting his bid, disclose any and all payments he has made, is committed to or intends to make to agents, brokers or any other intermediaries in connection with the award of the Contract.
3. The Bidder(s)/Contractor(s) will not instigate third persons to commit offences outlined above or be an accessory to such offences.
4. The Bidder(s)/Contractor(s) will not, directly or through any other person or firm indulge in fraudulent practice means a wilful misrepresentation or omission of facts or submission of fake/forged documents in order to induce public official to act in reliance thereof, with the purpose of obtaining unjust advantage by or causing damage to justified interest of others and/or to influence the procurement process to the detriment of the Government interests.
5. The Bidder(s)/Contractor(s) will not, directly or through any other person or firm use Coercive Practices (means the act of obtaining something, compelling an action or influencing a decision through intimidation, threat or the use of force directly or indirectly, where potential or actual injury may befall upon a person, his/ her reputation or property to influence their participation in the tendering process).

Article 3: Consequences of Breach

Without prejudice to any rights that may be available to the Principal/Owner under law or the Contract or its established policies and laid down procedures, the Principal/Owner shall have the following rights in case of breach of this Integrity Pact by the Bidder(s)/Contractor(s) and the bidder/contractor accepts and undertakes to respect and uphold the Principal/Owner's absolute right:

1. If the Bidder(s)/Contractor(s), either before award or during execution of Contract has committed a transgression through a violation of Article 2 above or in any other form, such as to put his reliability or credibility in question, the Principal/Owner after giving 14 days' notice to the contractor shall have powers to disqualify the Bidder(s)/Contractor(s) from the tender process or terminate/determine the Contract, if already executed or exclude the Bidder/Contractor from future contract award processes. The imposition and duration of the exclusion will be determined by the severity of transgression and determined by the Principal/Owner. Such exclusion may be forever or for a limited period as decided by the Principal/Owner.
2. Forfeiture of EMD/Performance Guarantee/Security Deposit: If the Principal / Owner has disqualified the Bidder(s) from the tender process prior to the award of the contract or terminated/determined the contract or has accrued the right to terminate/determine the contract according to Article 3(1), the Principal/Owner apart from exercising any legal rights that may have accrued to the Principal/Owner, may in its considered opinion forfeit the entire amount of Earnest Money Deposit, Performance Guarantee and Security Deposit of the Bidder/Contractor.
3. Criminal Liability: If the Principal/Owner obtains knowledge of conduct of a bidder or Contractor, or of an employee or a representative or an associate of a bidder or Contractor which constitutes corruption within the meaning of IPC Act, or if the

Principal/Owner has substantive suspicion in this regard, the Principal/Owner will inform the same to law enforcing agencies for further investigation.

Article 4: Previous Transgression

- 1) The Bidder declares that no previous transgressions occurred in the last 5 years with any other Company in any country confirming to the anticorruption approach or with Central Government or State Government or any other Central/State Public Sector Enterprises in India that could justify his exclusion from the Tender process.
- 2) If the Bidder makes incorrect statement on this subject, he can be disqualified from the Tender process or action can be taken for banning of business dealings/ holiday listing of the Bidder/Contractor as deemed fit by the Principal/ Owner.
- 3) If the Bidder/Contractor can prove that he has resorted / recouped the damage caused by him and has installed a suitable corruption prevention system, the Principal/Owner may, at its own discretion, revoke the exclusion prematurely.

Article 5: Equal Treatment of all Bidders/Contractors/Subcontractors

- 1) The Bidder(s)/Contractor(s) undertake(s) to demand from all subcontractors a commitment in conformity with this Integrity Pact. The Bidder/Contractor shall be responsible for any violation(s) of the principles laid down in this agreement/Pact by any of its Subcontractors/ sub-vendors.
- 2) The Principal/Owner will enter into Pacts on identical terms as this one with all Bidders and Contractors.
- 3) The Principal/Owner will disqualify Bidders, who do not submit, the duly signed Pact between the Principal/Owner and the bidder, along with the Tender or violate its provisions at any stage of the Tender process, from the Tender process.

Article 6: Duration of the Pact

This Pact begins when both the parties have legally signed it. It expires for the Contractor/Vendor 12 months after the completion of work under the contract or till the continuation of defect liability period, whichever is more and for all other bidders, till the Contract has been awarded.

If any claim is made/lodged during the time, the same shall be binding and continue to be valid despite the lapse of this Pacts as specified above, unless it is discharged/determined by the Competent Authority of IWAI.

Article 7: Other Provisions

- 1) This Pact is subject to Indian Law, place of performance and jurisdiction is the Headquarters of the Division of the Principal/Owner, who has floated the Tender.
- 2) Changes and supplements need to be made in writing. Side agreements have not been made.
- 3) If the Contractor is a partnership or a consortium, this Pact must be signed by all the partners or by one or more partner holding power of attorney signed by all partners and consortium members. In case of a Company, the Pact must be signed by a representative duly authorized by board resolution.

- 4) Should one or several provisions of this Pact turn out to be invalid; the remainder of this Pact remains valid. In this case, the parties will strive to come to an agreement to their original intentions.
- 5) It is agreed term and condition that any dispute or difference arising between the parties with regard to the terms of this Integrity Agreement / Pact, any action taken by the Owner/Principal in accordance with this Integrity Agreement/ Pact or interpretation thereof shall not be subject to arbitration.

Article 8: LEGAL AND PRIOR RIGHTS

All rights and remedies of the parties hereto shall be in addition to all the other legal rights and remedies belonging to such parties under the Contract and/or law and the same shall be deemed to be cumulative and not alternative to such legal rights and remedies aforesaid. For the sake of brevity, both the Parties agree that this Integrity Pact will have precedence over the Tender/Contact documents with regard any of the provisions covered under this Integrity Pact.

IN WITNESS WHEREOF the parties have signed and executed this Integrity Pact at the place and date first above mentioned in the presence of following witnesses:

.....
 (For and on behalf of Principal/Owner)

.....
 (For and on behalf of Bidder/Contractor)

WITNESSES:

1.....
 (signature, name and address)

2.....
 (Signature, name and address)

Place:.....

Date:

(ii) SCHEDULES

SCHEDULE 'A': Salient Features of the work.

Name of Work:	Providing & fixing of rubber fenders and replacement of damaged/rusted chains and plates fitted with rubber fenders in various IWAI terminals
Estimated cost:	Rs.55.61 lakhs excluding GST.
Earnest Money:	Rs. 1,11,213/-.
Security Deposit:	10% of contract price.

SCHEDULE 'B': General Rules & Directions with reference to General Conditions of Contract: -

(i) Officer inviting tender	:	Director, IWAI, Kochi
(ii) Tender Accepting Authority	:	Director, IWAI
(iii) (a) Time allowed for submission of Performance Guarantee as per clause 3.1 of GCC from the date of issue of letter of acceptance	}	: 15 days
(b) Maximum allowable extension beyond the period provided in (iii) (a) above	}	: 7 days.
(iv) Percentage on Cost of Materials and Labour to cover all overheads & profits	}	: included in the estimate
(v) Standard Schedule of Rates	:	Not applicable
(vi) Specifications to be followed	:	Not applicable
(vii) Deviation Limit beyond which Clause 16.3, 16.4, 16.5 & 16.6	}	: 20% with approval of the Competent Authority
(viii) Competent Authority for grant extension of time under clause 34:-		
		(a) Regional Director (Field), IWAI (if the amount of contract is upto 50 lakhs).
		(b) Member (Technical), IWAI (if the amount of contract is upto 100 lakhs).
		(c) Vice-Chairman / Chairman, IWAI, Noida (if the cost of contract is more than 100 lakhs & up to 500 lakhs).

(d) Chairman, IWAI, Noida (if the amount of contract is more than 500 lakhs).

(ix) Competent Authority to levy liquidated damages for delay under clause 35:-

- (a) Regional Director (Field), IWAI (if the amount of contract is upto 50 lakhs).
- (b) Member (Technical), IWAI (if the amount of contract is upto 100 lakhs).
- (c) Vice-Chairman / Chairman, IWAI, Noida (if the cost of contract is more than 100 lakhs & up to 500 lakhs).
- (d) Chairman, IWAI, Noida (if the amount of contract is more than 500 lakhs).

(x) Competent Authority to determine the contract as per clause 36:-

- (A) Regional Director, Director (Field), IWAI (if the amount of contract is upto 50 lakhs).
- (B) Regional Director/Engineer-in-Charge with the prior approval of
 - (a) Member (Technical), IWAI (if the amount of contract is up to 100 lakhs).
 - (b) Vice-Chairman / Chairman, IWAI, Noida (if the cost of contract is more than 100 lakhs & up to 500 lakhs).
 - (c) Chairman, IWAI, Noida (if the amount of contract is more than 500 lakhs).

(xi) Milestones as per table given below:-

(Clause 34.5 & 34.6 shall be applicable only when the amount of the contract is more than 10 Crores).

Sl. No.	Milestone	Time Allowed (from date of start) in months	Amount to be withheld in case of non-achievement of mile stone
	Not applicable being less than Rs. 10 Crores.		

(xii) Competent authority to reschedule the milestones as per clause 34.5 } : Chairman, IWAI, Noida.

(xiii) Competent authority for foreclosure of contract in full or in part due to abandonment or reduction in scope of work as per Clause – 31:

- (A) Regional Director (Field), IWAI (if the amount of contract is upto 50 lakhs).
- (B) Regional Director / Engineer – in - Charge with the prior approval of
 - (a) Member (Technical), IWAI (if the amount of contract is upto 100 lakhs).
 - (b) Vice-Chairman / Chairman, IWAI, Noida (if the cost of contract is more than 100 lakhs & up to 500 lakhs).
 - (c) Chairman, IWAI, Noida (if the amount of contract is more than 500 lakhs).

(xiv) Incentive for early completion : Not applicable

(iii) **GENERAL CONDITION OF CONTRACT**

CONTENTS

CLAUSE-1	:	DEFINITIONS
CLAUSE-2	:	INTERPRETATIONS
CLAUSE-3	:	PERFORMANCE GUARANTEE
CLAUSE-4	:	SECURITY DEPOSIT
CLAUSE-5	:	SUFFICIENCY OF TENDER
CLAUSE-6	:	CONTRACT DOCUMENTS
CLAUSE-7	:	DISCREPANCIES AND ADJUSTMENT OF ERRORS
CLAUSE-8	:	DUTIES AND POWERS OF ENGINEER-IN-CHARGE'S REPRESENTATIVE
CLAUSE-9	:	ASSIGNMENT AND SUB-LETTING
CLAUSE-10	:	FACILITIES TO OTHER CONTRACTORS
CLAUSE-11	:	CHANGE IN CONSTITUTION OF THE FIRM TO BE INTIMATED
CLAUSE-12	:	COMMENCEMENT OF WORK
CLAUSE-13	:	WORKS TO BE CARRIED OUT IN ACCORDANCE WITH SPECIFICATIONS DRAWINGS AND ORDERS ETC.
CLAUSE-14	:	SETTING OUT THE WORKS
CLAUSE-15	:	URGENT WORKS
CLAUSE-16	:	DEVIATIONS, VARIATIONS, EXTENT & PRICING
CLAUSE-17	:	CONTRACTOR'S SUPERVISION
CLAUSE-18	:	INSTRUCTIONS AND NOTICE
CLAUSE-19	:	PLANT AND EQUIPMENT
CLAUSE-20	:	PATENT RIGHTS
CLAUSE-21	:	MATERIALS
CLAUSE-22	:	LAWS GOVERNING THE CONTRACT
CLAUSE-23	:	WATCH & WARD AND LIGHTING
CLAUSE-24	:	WORK DURING NIGHT OR ON SUNDAYS AND HOLIDAYS
CLAUSE-25	:	LABOUR
CLAUSE-26	:	MATERIALS OBTAINED FROM EXCAVATION SUCH AS FOSSILS, COINS ETC.
CLAUSE-27	:	FORCE MAJEURE
CLAUSE-28	:	LIABILITY FOR DAMAGE, DEFECTS OR IMPERFECTIONS AND RECTIFICATION THEREOF

- CLAUSE-29 : CONTRACTOR'S LIABILITY AND INSURANCE
- CLAUSE-30 : SUSPENSION OF WORKS
- CLAUSE-31 : FORE CLOSURE OF CONTRACT IN FULL OR IN PART DUE TO ABANDONMENT OR REDUCTION IN SCOPE OF WORK
- CLAUSE-32 : TERMINATION OF CONTRACT ON DEATH
- CLAUSE-33 : CARRYING OUT PART WORK AT THE RISK & COST OF THE CONTRACTOR
- CLAUSE-34 : COMPLETION TIME AND EXTENSIONS
- CLAUSE-35 : LIQUIDATED DAMAGES FOR DELAY
- CLAUSE-36 : WHEN THE CONTRACT CAN BE DETERMINED
- CLAUSE-37 : INSPECTION AND APPROVAL
- CLAUSE-38 : COMPLETION CERTIFICATE & COMPLETION PLANS
- CLAUSE-39 : MEASUREMENTS
- CLAUSE-40 : PAYMENT ON ACCOUNT
- CLAUSE-41 : TAXES, DUTIES AND LEVIES ETC
- CLAUSE-42 : TAX DEDUCTION AT SOURCE
- CLAUSE-43 : PAYMENT OF FINAL BILL
- CLAUSE-44 : OVER PAYMENTS AND UNDER PAYMENTS
- CLAUSE-45 : FINALITY CLAUSE
- CLAUSE-46 : SUM PAYABLE BY WAY OF COMPENSATION TO BE CONSIDERED IS REASONABLE WITHOUT PREFERENCE TO ACTUAL LOSS
- CLAUSE-47 : SETTLEMENT OF DISPUTES & ARBITRATION
- CLAUSE-48 : CLAIM
- CLAUSE-49 : INTEREST

GENERAL CONDITIONS OF CONTRACT

CLAUSE - 1: DEFINITIONS

In the contract, the following words & expression shall, unless context otherwise requires, have the meaning thereby respectively assigned to them:

- (i) **Contract:** means the documents forming the tender and acceptance thereof and the formal agreement executed between the competent authority on behalf of the Chairman, Inland Waterways Authority of India and the contractor, together within the documents referred to therein including these conditions, the specifications, designs, drawings and instructions issued from time to time by the Engineer-in-charge and all these documents taken together shall be deemed to form one contract and shall be complementary to one another
- (ii) **Contract sum;** means the amount arrived at by multiplying the quantities shown in the schedule of quantities and price by the respective item rates as allowed.
- (iii) **Contractor:** means the successful tenderer who is awarded the contract to perform the work covered under this tender document and shall be deemed to include the contractor's successors, executors, representatives or assign approved by the Engineer-in-charge.
- (iv) **Employer** means the Chairman, Inland Waterways Authority of India and his successors.
- (v) **IWAI/ Authority/ Department/ Owner** shall mean the Inland Waterways Authority of India, which invites tenders on behalf of the Chairman, IWAI and includes therein-legal representatives, successors and assigns.
- (vi) **Engineer-In-Charge (EIC)** means the Engineer officer authorised to direct, supervise and be In-charge of the works for the purpose of this contract who shall supervise and be in charge of the work.
- (vii) **Engineer-in-charge representative** shall mean any officer of the Authority nominated by the Engineer-in-charge for day to day supervision, checking, taking measurement, checking bills, ensuring quality control, inspecting works and other related works for completion of the project.
- (viii) **Chairman:** means Chairman of Inland Waterways Authority of India.
- (ix) **Vice Chairman:** means the Vice Chairman of the Authority
- (x) **Chief Engineer:** means the Chief Engineer of the Authority.
- (xi) **Director** means the Director of the Authority, as the case may be.
- (xii) **Deputy Director** means the Deputy Director of the Authority, as the case may be.
- (xiii) **Assistant Director** means the Assistant Director of the Authority, as the case may be.
- (xiv) **Assistant Hydrographic Surveyor** means the Assistant Hydrographic Surveyor of the Authority, as the case may be
- (xv) **Work Order** means a letter from the Authority conveying the acceptance of the tender/offer subject to such reservations as may have been stated therein.
- (xvi) **Day :** means a calendar day beginning and ending at mid-night.
- (xvii) **Week :** means seven consecutive calendar days
- (xviii) **Month :** means the one Calendar month.
- (xix) **Site** means the waterway and / or other places through which the works are to be executed.

- (xx) **Vessel** : Any inland vessel / dredger operating in the National Waterway including the dredging units of IWAI for carrying out the work.
- (xxi) **Drawings** : means the drawings referred to in the specifications and / or appended with the tender document, any modifications of such drawing approved in writing by the Engineer-in-Charge and shall also include drawings/ charts issued for actual execution of the work time to time by the Engineer-in-Charge.
- (xxii) **Urgent Works**: means any urgent nature which in the opinion of the Engineer-In-Charge become necessary at the time of execution and / or during the progress of work to obviate any risk or accident or failure or to obviate any risk of damage to the vessel structure, or required to accelerate the progress of work or which becomes necessary for security or for any other reason the Engineer-in-Charge may deem expedient.
- (xxiii) **Work / works**: means work / works to be executed in accordance with the contract.
- (xxiv) Schedules referred to in these conditions shall mean the relevant schedules annexed to the tender papers.
- (xxv) District specifications means the specifications followed by the State Government in the area where the work is to be executed.
- (xxvi) Tendered value means the value of the entire work as stipulated in the letter of award.

CLAUSE – 2: INTERPRETATIONS

- 2.1 Where the contract so requires, words imparting the singular only shall also include the plural and vice versa. Any reference to masculine gender shall whenever required include feminine gender and vice versa.
- 2.2 Heading and marginal notes in these General Conditions shall not be deemed to form part thereof or be taken into consideration in the interpretation of construction thereof of the contract.

CLAUSE – 3: PERFORMANCE GUARANTEE

- 3.1 The contractor shall be required to deposit an amount equal to 5% of the contract sum as performance guarantee through RTGS in the A/c. No. 39360627884 of Inland Waterways Authority of India, maintained at State Bank of India, Vyttila Branch (IFS Code: SBIN0008694) within 15 days of the issue of the work order. Bank guarantee will not be accepted as performance guarantee.
- 3.2 After recording of the completion certificate for the work by the competent authority, and completion of defects liability period, the performance guarantee shall be returned to the contractor without any interest.
- 3.3 In the event of contract being determined under the provision of any of the clauses/ conditions of agreement, the performance guarantee shall be forfeited in full and shall be absolutely at the disposal of the authority.

CLAUSE – 4: SECURITY DEPOSIT

- 4.1 A sum @ 10% of the gross amount of the bill shall be deducted from each running bill of the contractor till the sum along with the sum already deposited as the EMD in the form of RTGS/NEFT will amount to Security Deposit of 5% of the contract value of work. The EMD of the successful Bidder submitted in the form of RTGS / NEFT will be retained as Security Deposit. Bank guarantee will not be accepted as security deposit.

In case of MSE registered firms, deduction of a sum of 10% of the gross amount of the bill from each running bill till that amount reaches 5% of the contract value of the work Security Deposit will also be made.

- 4.2 The total security deposit shall remain with IWAI till the completion of the contract and handing over of the site back to IWAI and the defect liability period is over or the payment of the final bill payable in accordance with agreement conditions whichever is later, provided the Engineer-in-Charge is satisfied that there is no demand outstanding against the contractor.
- 4.3 No interest will be paid on security deposit.
- 4.4 If the contractor neglects to observe or fails to perform any of his obligations under the contract, it shall be lawful for the Employer/ EIC to forfeit either in whole or in part, the security deposit furnished by the contractor. However, if the contractor duly performs and completes the contract in all respects and presents in absolute "NO DEMAND CERTIFICATE" in the prescribed form, the IWAI shall refund the security deposit to the contractor after deduction of cost and expenses that the Authority may have incurred and other money including all losses and damages which the Authority is entitled to recover from the Contractor.
- 4.5 In case of delay in the progress of work, the Engineer- in-Charge shall issue to the contractor a memo in writing pointing out the delay in progress and calling upon the contractor to explain the causes for the delay within 3 days of receipt of the memo and 10 days from issuance of memo whichever is earlier. If the Engineer-in-Charge is not satisfied with the explanations offered, he may forfeit the security deposit and / or withhold payment of pending bills in whole or in part and/ or get the measures of rectification of progress of work accelerated to the pre-defined level at the risk and cost of the contractor.
- 4.6 All compensation or other sums of money payable by the contractor under the terms of the contract or any other contract or on any other account whatsoever, may be deducted from or paid by the sale of a sufficient part of his security or from the interest arising there from or from any sums which may be due or may become due to the contractor by the Authority on any account whatsoever. Also in the event of the contractor's security deposit being reduced by reasons of such deductions or sale, as aforesaid the contractor shall, within 14 days of receipt of notice of demand from the Engineer-in-Charge make good the deficit in his security deposit.
- 4.7 In case the contractor fails to commence the works or when the contractor has defaulted for more than thirty days or when any amount is to be recovered from the contractor as penalty or deduction and the contractor fails to remit such amount even after due notice is given to him in this regard, IWAI at its own discretion may recover the sum from his security deposit.

CLAUSE – 5: SUFFICIENCY OF TENDER

The contractor shall be deemed to have satisfied himself before tendering as to the correctness and sufficiency of his tender for the works and of the rates quoted in the schedule of Quantities and Prices which shall (except as otherwise provided in the contract) cover all his obligations under the contract and all matters and things necessary for the proper execution and completion of the works in accordance with the provisions of the contract and its operation during execution of work.

CLAUSE – 6: CONTRACT DOCUMENTS

- 6.1 The language in which the contract documents shall be drawn up shall be English and if the said documents are written in more than one languages, the language according to which the contract is to be constructed and interpreted shall be English.
- 6.2 The Contractor shall be furnished free of charge certified true copy of the contract document.
- 6.3 A copy of the Contract Documents furnished to the Contractor as aforesaid shall be kept by the Contractor on the Site in good condition and the same shall at all reasonable time be available for inspection and use by the Engineer-in-Charge, his representatives or by other Inspecting officers of the Authority.
- 6.4 None of these Documents shall be used by the Contractor for any purpose other than that of this contract.

CLAUSE – 7: DISCREPANCIES AND ADJUSTMENT OF ERRORS

- 7.1 Detailed drawings shall be followed in preference to small-scale drawings and figured dimensions in preference to scaled dimensions. The case of discrepancy between the Schedule of Quantities and prices, the Specifications and/ or the drawings, the following order of precedence shall be observed : -
 - (a) Description in the Schedule of Quantities and Prices.
 - (b) Relevant Specifications and Special Conditions, if any.
 - (c) Drawings.
 - (d) Indian Standards Specifications of BIS.
- 7.2 The contractor shall study and compare the drawings, specifications and other relevant information given to him by the Engineer-in-Charge and shall report in writing to the Engineer-in-Charge any discrepancy and inconsistency which he notes. The decision of the Engineer-in-Charge regarding the correct intent and meaning of the drawings and specifications shall be final and binding.
- 7.3 Any error in description, quantity or price in Schedule of Quantities and Prices or any omission there-from shall not vitiate the Contract or release the Contractor from the execution of the whole or any part of the work(s) comprised therein according to drawings and specifications or from any of his obligations under the contract.
- 7.4 If on check there is difference in the amount worked out by contractor in the schedule of quantities and prices and General summary the same shall be adjusted in accordance with the following rules:
 - (a) In the event of error/discrepancy occurring in the rates written in figures and words, then the rate which corresponds with the amount worked out by the contractor shall, unless otherwise proved, be taken as correct. If the amount of an item is not worked out by the contractor or it does not correspond with the rate written either in figures or in words, then the rate quoted by the contractor in words shall be taken as correct. When the rate quoted by the contractor in figures and words tally, but the amount is not worked out correctly, the rate quoted by the contractor will, unless or otherwise proved, be taken as correct.
 - (b) All errors in totaling in the amount column and in carrying forward totals shall be corrected.
 - (c) The totals of various sections of schedule of quantities and price amended shall be carried over to the General Summary and the tendered sum amended accordingly. The tendered sum so altered shall, for the purpose of tender, be substituted for the sum

originally tendered and considered for acceptance instead of the original sum quoted by the tenderer. Any rounding off of quantities or in sections of schedule of quantities and prices or in General summary by the tenderer shall be ignored.

CLAUSE-8: DUTIES AND POWERS OF THE ENGINEER-IN-CHARGE REPRESENTATIVE

- 8.1 The duties of the representative of the Engineer-in-Charge are to watch and supervise the works and to test and examine any materials/ parts to be used or workmanship achieved in connection with the works.
- 8.2 The Engineer-in-Charge may, from time to time in writing, delegate to his representative any of the powers and authorities, vested in the Engineer-in- Charge and shall furnish to the contractor a copy of all such written delegation of powers and authorities. Any written instruction or written approval given by the representative of the Engineer-in-Charge to the contractor within the terms of such delegation shall bind the contractor and the Authority as though it has been given by the Engineer-in-Charge.
- 8.3 Failure of the representative of the Engineer-in-Charge to disapprove any work or materials shall be without prejudice to the power of the Engineer-in-Charge thereafter to disapprove such work or materials and to order the pulling down, removal or breaking up thereof. The contractor shall, at his own expense, again carry out such works as directed by the Engineer-in-Charge.
- 8.4 If the Contractor is dissatisfied with any decision of the representative of the Engineer-in-Charge, he will be entitled to refer the matter to the Engineer-in- Charge who shall thereupon confirm, reverse or vary such decision and the decision of the Engineer-in- Charge in this regard shall be final and binding on the contractor.

CLAUSE – 9: ASSIGNMENT AND SUB-LETTING

The Contractor shall not sub-let, transfer or assign the whole or any part of the work under the contract. Provided that the Engineer-in-Charge may at his discretion, approve and authorize the Contractor to sub-let any part of the work, which in his opinion, is not substantial, after the contractor submits to him in writing the details of the part of the work(s) or trade proposed to be sublet, the name of the sub-contractor thereof together with his past experience in the said work/trade and the form of the proposed sub-contract. Nevertheless any such approval or authorization by the Engineer-in-Charge shall not relieve the contractor from his any or all liabilities, obligations, duties and responsibilities under the contract. The contractor shall also be fully responsible to the Authority for all the acts and omissions of the sub-contractor, his employees and agents or persons directly employed by the contractor. However, the employment of piece rate works shall not be construed as sub-letting.

CLAUSE – 10: FACILITIES TO OTHER CONTRACTORS

The contractors shall, in accordance with the requirements of the work as decided by the Engineer-in- Charge, afford all reasonable facilities to other contractors engaged contemporaneously on separate contracts and for departmental labour and labour of any other agency properly authorised by Authority or any statutory body which may be employed at the site for execution of any work not included in the contract which the Authority may enter into in connection with or ancillary to the works. In all matters of conflict of interest, the Engineer-in-Charge shall direct what compromise should be made and his decision shall be final and binding on the parties.

CLAUSE – 11: CHANGE IN THE CONSTITUTION OF THE FIRM TO BE INTIMATED

Where the contractor is a partnership firm, prior approval in writing of the Engineer-in-Charge shall be obtained before any change is made in the constitution of the firm. Where the contractor is an individual or a Hindu Undivided Family business concern, such approval, as aforesaid, shall like-wise be obtained before the contractor enters into any partnership agreement where under the partnership firm would have the right to carry out the works hereby undertaken by the contractor. If prior approval as aforesaid is not obtained the contractor shall be deemed to have been assigned in contravention to Clause 36 hereof and the same action will be taken and the same consequences shall ensure as provided for in the said clause-36.

CLAUSE – 12: COMMENCEMENT OF WORK

The contractor shall commence the work at the respective sites within 15 days of the issue of Letter of Award. If the contractor commits default in mobilization of resources, and equipment as aforesaid, the Engineer-in-Charge shall without prejudice to any other right or remedy be at liberty to cancel the contract and forfeit the earnest money/security deposit.

CLAUSE–13: WORKS TO BE CARRIED OUT IN ACCORDANCE WITH SPECIFICATION DRAWINGS AND ORDERS ETC.

- 13.1 The contractor shall execute the whole and every part of the work in the most substantial and workman like manner in strict conformity with the specifications laid down in the contract document or as may be laid down by the Engineer-in-Charge under the terms of the contract. The contractor shall also conform exactly, fully and faithfully to the designs, drawings specifications and instructions in writing in respect of the work, duly signed by the Engineer-in-Charge as may be issued from time to time.
- 13.2 The contractor shall be entitled to receive, on demand, in addition to the contract documents, in accordance with the provisions of contract, the documents set forth herein in respect of the work on commencement or during the performance of the contract:
 - (a) Specifications or revisions thereof other than standard printed specifications and charts/drawings issued to the contractor from time to time
 - (b) Explanations, instructions etc.

Such further drawings, explanation, modifications and instruction, as the Engineer-in-Charge may issue to the contractor from time to time in respect of the work shall be deemed to form integral part of the contract and the contractor shall be bound to carry out the work accordingly.

- 13.3 In the case of any class of work for which there is no specifications, such work shall be carried out in accordance with the Bureau of Indian Standards specifications. In case there are no such specifications in the BIS, work shall be carried out as per manufacturer's specifications, if manufacturer's specifications are also not available then as per District specifications. In case there are no such specifications as required, above the work shall be carried out in all respect in accordance with the instructions and requirements of the Engineer-in-Charge.
- 13.4 All instructions and orders in respect of the work shall be given by the Engineer-in-Charge in writing. However, any verbal instructions or order shall be confirmed by the Engineer-in-Charge as soon as practicable without loss of time and only such written instruction shall be deemed to be valid.

CLAUSE – 14: SETTING OUT THE WORKS

The contractor shall provide all assistance and adhere to the instruction of E.I.C during the course of surveying, inspection, etc.

CLAUSE – 15: URGENT WORKS

If any urgent work (in respect of which the decision of the Engineer-in-Charge shall be final and binding) becomes necessary, the contractor shall execute the same as may be directed by Engineer-in-Charge, provided the directions are in accordance and confirmatory with provisions in Clause – 8.

CLAUSE – 16: DEVIATIONS, VARIATIONS, EXTENT AND PRICING

- 16.1 The Engineer-in-Charge shall have power (i) to make alteration in, omissions from, additions to, or substitutions for the original specifications, drawings, designs and instructions that may appear to him to be necessary or advisable during the progress of the work, and (ii) to omit a part of the works in case of non-availability of a portion of the site or for any other reasons and the contractor shall be bound to carry out the works in accordance with any instructions given to him in writing signed by the Engineer-in-Charge and such alterations, omissions, additions or substitutions shall form part of the contract as if originally provided therein and any altered, additional or substituted work which the contractor may be directed to do in the manner specified above as part of the works, shall be carried out by the contractor on the same conditions in all respects including price on which he agreed to do the main work except as hereafter provided.
- 16.2 The time for completion of the works shall, in the event of any deviations resulting in additional cost over the tendered value sum being ordered, be extended, if requested by the contractor, as follows:
- (i) In the proportion which the additional cost of the altered, additional or substituted work, bears to the original tendered value plus
 - (ii) 20% of the time calculated in (i) above or such further additional time as may be considered reasonable by the Engineer-in-Charge after approval of the Competent Authority.
- 16.3 In the case of extra item(s) (items that are completely new, and are in addition to the items contained in the contract), the contractor may within fifteen days of receipt of order or occurrence of the item(s) claim rates, supported by proper analysis, for the work and the Engineer-in-Charge shall within one month of the receipt of the claims supported by analysis, after giving consideration to the analysis of the rates submitted by the contractor, determine the rates on the basis of the market rates and the contractor shall be paid in accordance with the rates so determined.
- 16.4 In the case of substituted items (items that are taken up with partial substitution or in lieu of items of work in the contract), the rate for the agreement item (to be substituted) and substituted item shall also be determined in the manner as mentioned in the following Para.
- (a) If the market rate for the substituted item so determined is more than the market rate of the agreement item (to be substituted), the rate payable to the contractor for the substituted item shall be the rate for the agreement item (to be substituted) so increased to the extent of the difference between the market rates of substituted item and the agreement item (to be substituted).

- (b) If the market rate for the substituted item so determined is less than the market rate of the agreement item (to be substituted), the rate payable to the contractor for the substituted item shall be the rate for the agreement item (to be substituted) so decreased to the extent of the difference between the market rates of substituted item and the agreement item (to be substituted).
- 16.5 In the case of contract items, substituted items, contract cum substituted items, which exceed the deviation limits laid down in Schedule 'B', the contractor may within fifteen days of receipt of order or occurrence of the excess, claim revision of the rates, supported by proper analysis for the work in excess of the above mentioned limits, provided that if the rates so claimed are in excess of the rates specified in the schedule of quantities, the Engineer-in-Charge shall within one month of receipt of the claims supported by analysis, after giving consideration to the analysis of the rates submitted by the contractor, determine the rates on the basis of the market rates and the contractor shall be paid in accordance with the rates so determined.
- 16.6 The provisions of the paragraph 16.4 above shall also apply to the decrease in the rates of items for the work in excess of the limits laid down in Schedule 'B', and the Engineer-in-Charge shall after giving notice to the contractor within one month of occurrence of the excess and after taking into consideration any reply received from him within fifteen days of the receipt of the notice, revise the rates for the work in question within one month of the expiry of the said period of fifteen days having regard to the market rates.
- 16.7 Under the circumstances, the contractor shall at any stage not suspend the work on account of non-settlement of rates of such Deviated/Extra/Substituted items.

CLAUSE - 17: CONTRACTOR'S SUPERVISION

- 17.1 The contractor shall either himself supervise the execution of the works or shall appoint at his own expense, a qualified and experienced Engineer as his accredited agent approved by the Engineer-in-Charge, if contractor has himself not sufficient knowledge or experience to be capable of receiving instruction or cannot give his full attention to the works. The contractor or his agent shall be present at the site(s) and shall supervise the execution of the works with such additional assistance in each trade, as the work involved shall require and considered essential by the Engineer-in-Charge. Further the directions/instructions given by the Engineer-in-Charge to the contractor's agent shall be considered to have the same force as if these had been given to the contractor himself.
- 17.2 If the contractor fails to appoint a suitable agent as directed by the Engineer-in-Charge, the Engineer-in-Charge shall have full powers to suspend the execution of the works until such date as a suitable agent is appointed by the contractor and takes over the charge of supervision of the work. For any such suspension, the contractor shall be held responsible for delay so caused to the work.

CLAUSE - 18: INSTRUCTIONS AND NOTICE

- 18.1 Except as otherwise provided in this contract, all notices to be given on behalf of the Authority and all other actions to be taken on its behalf may be given or taken by the Engineer-in-Charge or any officer for the time being entrusted with the functions, duties and powers of the Engineer-in-Charge.
- 18.2 All instructions, notices and communications etc. under the contract shall be given in writing and any such oral orders / instructions given shall be confirmed in writing and no such communication which is not given or confirmed in writing shall be valid.

- 18.3 All instructions, notices and communications shall be deemed to have been duly given or sent to the contractor, if delivered to the contractor, his authorized agent, or left at, or posted to the address given by the contractor or his authorized agent or to the last known place of abode or business of the contractor or his agent of services by post shall be deemed to have been served on the date when in the ordinary course of post these would have been delivered to him and in other cases on the day on which the same were so delivered or left.
- 18.4 The Engineer-in-Charge shall communicate or confirm the instructions to the contractor in respect of the execution of work through a “Site Order Book“ maintained in the office of the Engineer-in-Charge and the contractor or his authorized representative shall confirm receipt of such instructions by signing the relevant entries in this book. If required by the Contractor, he shall be furnished a certified true copy of such instruction(s). The pro-forma for Site Order Book to be maintained at site is given in Annex – 4.
- 18.5 The “Hindrance Register” shall be maintained at the site of work, where any hindrance which comes to the notice of the representative of the Engineer-in-Charge shall be recorded and immediately a report will be made to the Engineer-in-Charge within a week. The Engineer-in-Charge shall review the Hindrance Register at least once in a month. The pro-forma on which the Hindrance Register shall be maintained is given in Annex – 5.

CLAUSE -19: PLANT AND EQUIPMENT

- 19.1 The plants and equipments required for the execution of dredging works and all additional necessary plant, equipment and machinery required for the execution of the work under the contract shall be brought to the site by the Contractor at his cost and shall use such methods and appliances for the purpose of all the operations connected with the work covered by the contract, which shall ensure the completion of work(s) within the specified time.
- 19.2 The contractor shall operate, maintain, repair and safeguard the plants and equipments during the tenancy of the contract in accordance with terms and conditions, specifications of the contract and instructions of the Engineer in Charge.
- 19.3 Subject to the availability of any item(s), plant, equipment and machinery, the Authority at the written request of the contractor, may issue to the contractor on hire for being deployed on the work contracted for, at pre- determined rates, terms and conditions at the sole discretion of the Engineer-in-Charge.

CLAUSE – 20: PATENT RIGHTS

The contractor shall indemnify the Authority, its representatives or its employees against any action, claim or proceeding relating to infringement or use of any patent or design or any alleged patent or design rights and shall pay any royalties or other charges which may be payable in respect of any article or material or part thereof included in the contract. In the event of any claim being made or action being brought against the Authority or any agent, servant or employee of the Authority in respect of any such materials as aforesaid the contractor shall immediately be notified thereof. Provided that such indemnification shall not apply when such infringement has taken place in complying with the specific directions issued by the Authority but the contractor shall pay any royalties or other charges payable in respect of any such use, the amount so paid being reimbursement to the contractor only if the use was the result of any drawings and or specifications issued after submission of the tender.

CLAUSE – 21: MATERIALS

- 21.1 The contractor shall at his own expenses provide / arrange all materials required for the bona-fide use on work under the contract.
- 21.2 All materials/parts to be provided by the contractor shall be in conformity with the specifications laid down in the contract and the contractor shall furnish from time to time proof and samples, at his own cost, the materials/parts as may be specified by the Engineer-in-Charge. Further the Engineer-in-Charge shall also have powers to have such tests, in addition to those specified in the contract, as may be required and the contractor shall provide all facilities to carry out the same. The cost of materials/parts consumed in such tests and also the expenses incurred thereon including the cost of the testing charges, shall be borne by the contractor in all cases and also where such tests which are in addition to those provided in the contract disclose that the materials are in conformity with the provisions of the contract.
- 21.3 The Engineer-in-Charge or his representative shall be entitled at any time to inspect and examine any plants, materials/parts intended to be used in the works, either on the site or at factory or workshop or other place(s) where such materials are assembled, fabricated, manufactured or any place where these are lying or from where these are being obtained. For this, purpose, the contractor shall afford such facilities as may be required for such inspection and examination.

CLAUSE - 22: LAWS GOVERNING THE CONTRACT

The Courts at **Noida** only shall have the jurisdiction for filing the award of the arbitration and for any other judicial proceedings.

CLAUSE - 23: WATCH & WARD AND LIGHTING

The Contractor shall provide and maintain at his expense all lights, guards, fencing and watch & ward when and where necessary or as required by the Engineer-in-Charge for the protection of the works or for the safety and convenience of those employed on the works or the public.

CLAUSE - 24: WORK DURING NIGHT OR ON SUNDAYS AND HOLIDAYS

- 24.1 Subject to any provisions to the contrary contained in the contract, none of the works shall be carried out during Sundays and national holidays without the permission in writing of the Engineer-in-Charge. However, when work is unavoidable or necessary for safety of life, property or works, contractor shall take necessary action immediately and advise the Engineer-in-Charge accordingly.
- 24.2 The Engineer-in-Charge at its discretion may, however, direct the contractor that the work may be carried out on holidays, Sundays and/or in extra shifts to ensure completion of works under the contract as scheduled.

CLAUSE - 25: LABOUR

- 25.1 (a) The contractor shall employ labour in sufficient numbers to maintain the required rate of progress and of quality to ensure workmanship of the degree specified in the contract and to the satisfaction of the Engineer-in-Charge. The Contractor shall not employ in connection with the works any person who has not completed eighteen years of age the minimum age specified in Indian Labour Law.

- (b) If any foreigner is employed by the contractor on the work within the site the later shall ensure that such foreigner possesses the necessary special permit issued by the Civil Authorities in writing and also comply with the instructions issued there-from from time to time. In the event of any lapse in this regard on the part of such foreigner the contractor shall be personally held responsible for the lapse & Authority shall not be liable in any event.
 - (c) The Contract is liable for cancellation if either the contractor himself or any of his employee is found to be a person who has held Class-I post under the Authority immediately before retirement and has within two years of such retirement accepted without obtaining the previous permission of the Authority or of the Chairman as the case may be and employment as contractor for, or in connection with the execution of the public works, or as an employee of such contractor. If the contract is terminated on account of the failure of the contractor to comply with the above clause, the Authority shall be entitled to recover from him such damages as may be determined by the Engineer-in-Charge with due regard to the inconvenience caused to the Authority on account of such termination without prejudice to the Authority's right to proceed against such officer.
- 25.2 The contractor shall furnish and deliver fortnightly to the Engineer-in-Charge, a distribution return of the number and description by trades of the works of people employed on the works. The contractor shall also submit on the 4th and 19th of every month for the period of second half of the preceding month and first half of the current month respectively to the Engineer-in-Charge, a true statement in respect of the following.
- i) Any accident if occurred during the said fortnight showing the circumstances under which it happened and the extent of damage and injury caused by it and.
 - ii) The number of female workers who have been allowed maternity benefit as provided in the Maternity Benefit Act 1961 or Rules made there-under and the amount paid to them.
- 25.3 The Contractor shall pay to labourer employed by him either directly or through sub-contractors wages not less than wages as defined in Minimum Wages Act 1948 and Contract Labour (Regulation and Abolition) Act 1970 amended from time to time and rules framed there-under and other labour laws affecting contract labour that may be brought in force from time to time.
- 25.4 The Contractor shall also comply with the provisions of all Acts, Laws, any Regulation or Bye Laws of any Local or other Statutory Authority applicable in relation to the execution of works such as:
- i) Payment of Wages Act, 1936 (Amended)
 - ii) Minimum Wages Act, 1948 (Amended).
 - iii) The Contract Labour (Regulation & Abolition) Act, 1970 with Rules framed there under as amended.
 - iv) Workmen Compensation Act, 1923 as amended by Amendment Act no.65 of 1976.
 - v) Employer's Liability Act 1938 (Amended)
 - vi) Maternity Benefit Act. 1961 (Amended)
 - vii) The Industrial Employment (Standing orders) Act 1946 (Amended).
 - viii) The Industrial Disputes Act. 1947 (Amended)

- ix) Payment of Bonus Act.1965 and Amended Act No. 43 of 1977 and No. 48 of 1978 and any amended thereof:
- x) The Personal Injuries (Compensation Insurance) Act 1963 and any modifications thereof and rules made there-under from time to time. The Contractor shall take into account all the above and financial liabilities in his quoted rates and nothing extra, whatsoever, shall be payable to him on this account.

The list is indicative only, otherwise the contractor should be aware of all the Acts/Labour Laws and should follow diligently on the work. The contractor shall be fully and personally responsible for the violation of any Act/Labour Law

- 25.5 The Contractor shall be liable to pay his contribution and the employees contribution to the State Insurance Scheme in respect of all labour employed by him for the execution of the contract, in accordance with the provision of "the Employees State insurance Act 1948" as amended from time to time. In case the Contractor fails to submit full details of his account of labour employed and the contribution payable, the Engineer-in- Charge shall recover from the running bills the contribution amount as assessed by him. The amount so recovered shall be adjusted against the actual contribution payable for Employees State Insurance.
- 25.6 The Engineer-in-Charge shall on a report having been made by an inspecting officer as defined in the Contract Labour (Regulation and Abolition) Act and Rules or on his own in his capacity as Principal Employer, have the power to deduct from the amount due to the contractor any sum required for making good the loss suffered by worker(s) by reason of non-fulfillment of the conditions of the Contract for the benefit of Workers, nonpayment of wages or on account of deduction made from the wages of the workers which are not justified by the terms of the contract or non- observance of the said Act and Rules framed there under with amendments made from time to time.
- 25.7 The Contractor shall indemnify the Authority against any payments to be made under and for observance of the Regulation Laws, Rules as stipulated in Clause-25.4 above without prejudice to his right to claim indemnity from his sub-contractors. In the event of the contractor's failure to comply with the provisions of all the Acts/Laws stipulated in Clause-25.4 or in the event of decree or award or order against the contractor having been received from the competent authority on account of any default or breach or in connection with any of the provisions of the Acts/Laws/Rules mentioned in Sub-Clause 25.4 above, the Engineer-in-Charge without prejudice to any other right or remedy under the contract shall be empowered to deduct such sum or sums from the Bill of the contractor or from his security deposit or from other payment due under this contract or any other contract to satisfy within a reasonable time the provisions of the various Acts/Laws/Rules/Codes as mentioned under Sub-Clause 25.4 above, on the part of the contractor under the contract on behalf of and at the expenses of the contractor and make payment and /or provide amenities/ facilities/services accordingly. In this regard, the decision of the Engineer-in-Charge shall be conclusive and binding on the contractor.
- 25.8 In the event or the Contractor committing a default or breach of any of the provisions of the aforesaid Contract's Labour (Regulation and Abolition) Act and Rules as amended from time to time or furnishing any information or submitting or filling any form/Register/Slip under the provisions of these Regulations which is materially incorrect then on the report of the Inspecting officer as defined in the relevant Acts and Rules as referred in Clause 25.4 above, the Contractor shall without prejudice to any other liability pay to the Authority a sum not exceeding Rs.50/- (Rs. Fifty only) as liquidated damages for every default, breach or furnishing, making, submitting, filling materially incorrect statement as may be fixed by the Engineer-in-Charge. The decision of the Engineer-in-Charge in this respect shall be final & binding.

- 25.9 The Contractor shall at his own expenses comply with or cause to be complied with the Provisions/ Rules provided for welfare and health of Contract Labour in the Contract Labour (Regulation and Abolition) Act and other relevant Acts and Rules framed there under or any other instructions issued by the Authority in this regard for the protection of health and for making sanitary arrangements for workers employed directly or indirectly on the works. In case the contractor fails to make arrangements as aforesaid, the Engineer-in-Charge shall be entitled to do so and recover the cost thereof from the contractor.
- 25.10 The Contractor shall at his own expense arrange for the safety or as required by the Engineer-in-Charge, in respect of all labour directly or indirectly employed for performance of the Works and shall provide all facilities in connection therewith. In case the contractor fails to make arrangements and provide necessary facilities as aforesaid, the Engineer-in-Charge shall be entitled to do so and recover the cost thereof from the Contractor. But this will not absolve the contractor of his responsibility or otherwise thereof.
- 25.11 Failure to comply with "Provisions/Rules made for Welfare and Health of Contract Labour" Safety Manual, or the provisions relating to report on accidents and grant of maternity benefits to female workers and the relevant Acts/Rules referred in clause 25.4 above shall make the contractor liable to pay to the Authority as liquidated damages an amount not exceeding Rs. 50/- for each default or materially incorrect statement. The decision of the Engineer-in-Charge in such matters based on reports from the inspecting Officers as defined in the relevant Acts and Rules as referred in clause 25.4 above shall be final and binding and deductions for recovery of such liquidated damages may be made from any amount payable to the contractor. In the event of any injury, disability or death of any workmen in or about the work employed by the contractor either directly or through his sub-contractor, contractor shall at all time indemnify and save harmless the Authority against all claims, damages and compensation under the Workmen Compensation Act, 1923 as amended from time to time or in other Law for the time being in force and Rules there-under from time to time and also against all costs, charges and expenses of any smooth action by proceedings arising out of such accidents or injury, disability or death of a workmen and against all sum or sums which may with the consent of the contractor be paid to compromise or compound any claim in this regard. If any award, decree or order is passed against the contractor for recovery of any compensation under the Workmen Compensation Act, 1923, for any injury, disability or death of a workman by any competent court, the said sum or sums shall be deducted by the Engineer-in-Charge from any sum then due or that may become due to the contractor or from his security deposit or sale thereof in full or part under the contract or any other contract with the Authority towards fulfillment of the said decree, award or orders.
- 25.12 Provided always that the contractor shall have no right to claim payments/claims whatsoever on account of his compliance with his obligations under this clause and Labour Regulations.
- 25.13 The contractor shall not otherwise than in accordance with the statutes ordinance and Government Regulations or orders for the time being in force import, sell, give, barter or otherwise dispose of any alcoholic liquor or drugs to permit or suffer any such import, sale, gift, barter or disposal by his sub-contractor, agent or employees.
- 25.14 The contractor shall not give, barter or otherwise dispose of to any person or persons any arms or ammunition of any kind or permit to suffer the same as aforesaid.
- 25.15 The Contractor shall employ for the execution of the works only such persons as are skilled and experienced in their respective trades and Engineer-in-Charge shall be at liberty to object to and require the contractor to remove from the works any persons employed by the Contractor for the execution of the works who, in the opinion of the Engineer-in-Charge, misconduct himself or is incompetent or negligent in the proper performance of his duties.

The contractor shall forthwith comply with such requisition and such person shall not be again employed upon the works without permission of the Engineer-in-Charge.

- 25.16 Release of Security deposit after labour clearance: Security deposit of the work shall not be refunded till the contractor produces a clearance certificate from the Labour Officer. As soon as the work is virtually completed, the contractor shall apply for clearance certificate to the Labour Officer under intimation to Engineer-in-Charge. The Engineer-in-Charge on the receipt of such communication shall write to Labour Officer to intimate if any complaint is pending against the contractor in respect of the work. If no complaint is pending on record till after three months after completion of work and/or no communication is received from Labour Officer to this effect till six months after the date of completion, it will be deemed to have received the clearance certificate and the security deposit will be released if otherwise due.

CLAUSE – 26: MATERIALS OBTAINED FROM EXCAVATION SUCH AS COINS, FOSSILS, ETC.

- 26.1 Materials of any kind obtained from excavation on the site shall remain the property of the Authority and shall be disposed off as directed by the Engineer-in-Charge.
- 26.2 However if any of the materials thus obtained from excavation on the site is such as can be used in the execution of the work under the contract, the contractor will be allowed to use the same free of cost (except that any amount of royalty paid for in this regard by the Authority shall be recoverable from the contractor) for the aforesaid purpose provided the same is found suitable and is approved by the Engineer-in-Charge.
- 26.3 Fossils, coins, articles of value, structures and other remains or things of geological or archeological interest discovered on the site shall be the absolute property of the Authority. The contractor shall take reasonable precautions to prevent his labour or any other person from removing or damaging any such article or thing and shall acquaint the Engineer-in-Charge with such discovery and carryout the Engineer-in-Charge's directions as to the disposal of the same at the expense of the Authority.

CLAUSE – 27: FORCE MAJEURE

- 27.1 The term Force Majeure shall herein mean Riots (other than among the contractor's employees), Civil Commotion (to the extent no insurable), war (whether declared or not), invasion, act of foreign enemies, hostilation, civil war, rebellion, revolution, insurrection, military or usurped power, damage from aircraft, nuclear fission, acts of God, such as earthquake (above 7 magnitude on Richter Scale), lightning, unprecedented floods, fires not caused by contractor's negligence and other such causes over which the contractor has no control and are accepted as such by the Engineer-in-Charge, whose decision shall be final and binding. In the event of either party being rendered unable by Force Majeure to perform any obligation required to be performed by them under this contract, the relative obligation of the party affected by such Force Majeure shall be treated as suspended for the period during which such Force Majeure cause lasts, provided the party allowing that it has been rendered unable as aforesaid, thereby shall notify within 15 days of the alleged beginning and ending thereof giving full particulars and satisfactory evidence in support of such cause.
- 27.2 For delays arising out of Force Majeure, the bidder shall not claim extension in completion date for a period exceeding the period of delay attributable to the causes of Force Majeure and neither the Authority nor the bidder shall be liable to pay extra costs provided it is mutually established that Force Majeure conditions did actually exist.

- 27.3 If any of the Force Majeure conditions exists in the places of operation of the bidder even at the time of submission bid, he shall categorically specify in his bid and state whether they have been taken into consideration in their quotations.

CLAUSE - 28: LIABILITY FOR DAMAGE, DEFECTS OR IMPERFECTIONS AND RECTIFICATION THEREOF

- 28.1 If the contractor or his labour or his sub-contractor, injure, destroy or damage, battery, solar panel, lighting system, road, fence, enclosures, water pipe, cables, buildings, drains, electricity or telephone posts, wires, trees, grass line, cultivated land in the area in which they may be working or in the area contiguous to the premises on which the work or any part of it is being executed or if any damage is caused to any item belonging to IWAI or to any person during the progress of work, the Contractor shall upon receipt of a notice in writing in that behalf from the Engineer-in-Charge, make good the same at his cost.
- 28.2 If it appears to the Engineer-in-Charge or his representative at any time during the progress of work or prior to the expiration of the Defects Liability period that any work has been executed with unsound, imperfect or unskilled workmanship or that any materials or articles provided by the Contractor for execution of the work are unsound or of a quality inferior to that contracted for, or otherwise not in accordance with the Contract, or that any defect, shrinkage or other faults found in the work arising out of defective design or defective/improper materials or workmanship, the Contractor shall, upon receipt of a notice in writing in that behalf from the Engineer-in-Charge forthwith rectify or remove and reconstruct the work so specified in whole or in part, as the case may be, and/or remove the materials/articles so specified and provide other proper and suitable materials at his expense.
- 28.3 All damages caused by accidents or carelessness of the contractor or any of his employees or any property belonging to the Authority is wasted or is misused by the contractor or any of his employees shall be to the account of the contractor, who shall make good the loss.
- 28.4 Defects liability period for the works shall be 6 months from the date of completion of all works under the contract.

CLAUSE – 29: CONTRACTOR'S LIABILITY AND INSURANCE

- 29.1 From commencement to completion of the work(s) as a whole, the Contractor shall take full responsibility for the care thereof and for taking precautions to prevent loss or damage. He shall be liable for any damage or loss that may happen to the works or any part thereof and to the Authority's Plant, Equipment and Material (hired or issued to the Contractor) shall be in good order and condition and in conformity in every respect with the requirements of the Contract and instructions of the Engineer-in-Charge.
- 29.2 i) Neither party to the contract shall be liable to the other in respect of any loss or damage which may occur or arise out of "Force Majeure" to the works or any part thereof on to any material or article at site but not incorporated in the works or to any person or anything or material whatsoever or either party provided such a loss or damage could not have been foreseen or avoided by a prudent person and the either party shall bear losses and damages in respect of their respective men and materials. As such liability of either party shall include claims/ compensations of the third party also.
- ii) Provided, however, in an eventuality as mentioned in sub-clause - 29.2 (i) above, the following provisions shall also have effect:

- (a) The Contractor shall, as may be directed in writing by the Engineer-in-Charge proceed with the completion of the works under and in accordance with the provisions and conditions of the contract, and
 - (b) The Contractor shall, as may be directed in writing by the Engineer-in-charge, re-execute the works lost or damaged, remove from the site any debris and so much of the works as shall have been damaged and carry the Authority's T & P, Plant and Equipment, Material etc. to the Authority's store. The cost of such re-execution of the works, removal of damaged works and carrying of Authority's store shall be ascertained in the same manner as for deviations and this shall be added to the contract sum. Provided always that the Contractor shall, at his own cost, repair and make good so much of the loss or damage as has been occasioned by any failure on his part to perform his obligations under the contract or not taking precautions to prevent loss or damage or minimise the amount of such loss or damage, Final assessment of loss or damage shall be decided by the Engineer-in-Charge and his decision shall be final and binding.
- 29.3 The contractor shall take special precautions to see that public places and roads adjacent to contractor's yard are not blocked at anytime either by his material or by his workmen. The roads are to be kept always clear and no equipment/materials shall be stacked.
- 29.4 The navigable waterways shall not be blocked by Contractor's vessels. The anchors dropped in the waterways shall be properly marked and removed after done with.
- 29.5 The contractor shall indemnify and keep indemnified the Authority against all losses and claims for death, injuries or damage to any person or any property whatsoever which may arise out of or in consequence of the construction and maintenance, of works during the contract period and also against all claims, demands, proceedings, damages, costs, charges and expenses whatsoever in respect of or in relation thereto, and such liabilities shall include claims/compensations of the third party.
- 29.6 (a) Before commencing execution of the work, the Contractor shall without in any way limiting his obligations and responsibilities under this condition, insure against any damage, loss or injury which may occur to any property (excluding that of the Authority but including the Authority building rented to the contractor wholly or in part and any part of which is used in part and any part of which is used by him for storing combustible materials) public liability by arising out of the carrying out of the contract. For this purpose the contractor shall take out, pay all costs and maintain throughout the period of his contract public liability with the following coverage.
- i) Public liability limits for bodily injury or death not less than Rs. 1,00,000 for one person and Rs. 2,00,000 for each accident.
 - ii) Property liability limits for each accident not less than Rs. 1,00,000 ;
 - iii) The Contractor shall prove to the Engineer-in Charge from time to time that he has taken out all the insurance policies referred to above and has paid the necessary premiums for keeping the policies alive till expiry of the Defects Liability Period.
- (b) The Contractor shall ensure that similar insurance policies are taken out by his sub-contractor (if any) and shall be responsible for any claims or losses to the Authority resulting from their failure to obtain adequate insurance protection in connection thereof. The Contractor shall produce or cause to be produced by his sub-contractors (if any) as the case may be, relevant, policy or policies and premium receipt as and when required by the Engineer-in-Charge.

- (c) If the contractor and/or his sub- contractor (if any) shall fail to effect and keep in force the insurance referred to above or any other insurance which he/they may be required to effect under the term of the Contract then and in any such case the Authority may, without being bound to effect and keep in force any such insurance and pay such premium or premiums as may be necessary for that purpose and from time to time deduct the amount so paid by the Authority from any moneys due or which may become due to the contractor or recover the same as a debt due from the contractor.
- (d) The contractor shall at his own expense arrange for the safety provisions as required in respect of the works covered under this contract as per the instruction of Engineer-in-charge. In case, the contractor fails to comply with the provisions of the safety the Engineer- in-Charge shall be entitled to and make the necessary arrangements at the risk and cost of the contractor. This will, however, not absolve the Contractor of his overall responsibility to execute the works under the contract.

CLAUSE – 30: SUSPENSION OF WORKS

- 30.1 The contractor shall on the receipt of order of the Engineer-in-Charge (whose decision shall be final and binding on the contractor) suspend the progress of the works or any part thereof for such time or times and in such manner as the Engineer-in-Charge may consider necessary.
- 30.2 The suspension of the work can be done by Engineer-in-Charge for any of the following reasons:
 - (a) On account of any default on the part of the contractor or
 - (b) for proper execution of the works or part thereof for the reasons other than the default of the contractor or
 - (c) for the safety of the works or part thereof.
- 30.3 The contractor shall during the suspension period, properly protect and secure the works to the extent necessary and carry out the instructions given in that behalf by the Engineer-in-Charge.
- 30.4 If the suspension is ordered for the reasons under the Clause 30.2(b) and (c) above, the contractor shall be entitled to the extension of time equal to the period of every such suspension Plus 25% for the completion of the item or group of items of work for which a separate period of completion is specified in the contract and of which suspended work forms a part

CLAUSE – 31: FORECLOSURE OF CONTRACT IN FULL OR IN PART DUE TO ABANDONMENT OR REDUCTION IN SCOPE OF WORK

If at any time after acceptance of the tender the Authority decides to abandon or reduce the scope of the works for reason whatsoever and hence does not require the whole or any part of the works to be carried out, the Engineer-in-Charge (with the prior approval of competent authority mentioned in Schedule ‘B’) shall give notice in writing to that effect to the contractor and the Contractor shall have no claim to any payment of compensation or otherwise whatsoever, on account of any profit or advantage which he might have derived from the execution of the works in full but which he could not derive in consequence of the fore closure of the whole or part of the works.

CLAUSE – 32: TERMINATION OF CONTRACT ON DEATH

If the Contractor is an individual or a proprietary concern and the individual or the proprietor dies, or if the Contractor is a partnership concern and one of the partners dies, then,

unless the Engineer-in-Charge is satisfied that the legal representatives of the individual contractor or of the proprietor of the proprietary concern and in the case of partnership, the surviving partners are capable of carrying out and completing the contract, the Engineer-in-Charge shall be entitled to terminate the Contract as to its incomplete part without the Authority being in anyway liable to payment of any compensation whatsoever on any account to the estate of the deceased Contractor and/or to the surviving partners of the Contractor's firm on account of termination of the Contract. The decision of the Engineer-in-Charge that the legal representatives of the deceased contractor or the surviving partners of the Contractor's firm cannot carry out and complete the works under the contract shall be final and binding on the parties. In the event of such termination, the Authority shall not hold the estate of the deceased Contractor and/or the surviving partners of the Contractor's firm liable for damages for not completing the contract. Provided that the power of the Engineer-in-Charge of such termination of contract shall be without prejudice to any other right or remedy which shall have accrued or shall accrue to him under the contract.

CLAUSE- 33: CARRYING OUT PART OF WORK AT THE RISK AND COST OF THE CONTRACTOR

- 33.1 If the contractor
- (i) At any time makes default during the currency of work or does not execute any part of the work with due diligence and continues to do so even after a notice in writing of 7 days in this respect from the Engineer-in-Charge; **or**
 - (ii) Commits default in complying with any of the terms and conditions of the contract and does not remedy it or takes effective steps to remedy it within 7 days even after a notice in writing is given in that behalf by the Engineer-in-Charge; **or**
 - (iii) Fails to complete the work (s) or items of work with individual dates of completion, on or before the date (s) so determined, and does not complete them within the period specified in the notice given in writing in that behalf by the Engineer-in-Charge.
- 33.2 The Engineer-in-Charge without invoking action under clause 36 may, without prejudice to any other right or remedy against the contractor which have either accrued or accrue thereafter to IWAI, by a notice in writing to take the part work/ part incomplete work of any item (s) out of his hands and shall have powers to:
- (a) Take possession of the site and any materials, constructional plant, implements, stores, etc., thereon; and/ or
 - (b) Carry out the part work/ part incomplete work of any items (s) by any means at the risk and cost of the contractor.
- 33.3 The Engineer-in-Charge shall determine the amount, if any, is recoverable from the contractor for completion of the part work/ part incomplete work of any item (s) taken out of his hands and execute at the risk and cost of the contractor, the liability of contractor on account of loss or damage suffered by IWAI because of action under this clause shall not exceed 10% of the tendered value of the work.
- 33.4 In determining the amount, credit shall be given to the contractor with the value of work done in all respect in the same number and at the same rate as if it had been carried out by the original contractor under the terms of his contract, the value of contractor's materials taken over and incorporated in the work and use of plant and machinery belonging to the contractor. The certificate of the Engineer-in-Charge as to the value of work done shall be final and conclusive against the contractor provided always that action under this clause shall only be taken after giving notice in writing to the contractor. Provided also that if the expenses

incurred by the IWAI are less than the amount payable to the contractor at his agreement rates, the difference shall not be payable to the contractor.

- 33.5 Any excess expenditure incurred or to be incurred by IWAI in completing the part work/ part incomplete work of any item (s) or the excess loss of damages suffered or may be suffered by IWAI as aforesaid after allowing such credit shall without prejudice to any other right or remedy available to IWAI in law or per as agreement be recovered from any money due to the contractor on any account, and if such money is insufficient, the contractor shall be called upon in writing and shall be liable to pay the same within 30 days.
- 33.6 If the contractor fails to pay the required sum within the aforesaid period of 30 days, the Engineer-in-Charge shall have the right to sell any or all of the contractors' unused materials, constructional plant, implements, temporary building at site etc. and adjust the proceeds of sale thereof towards the dues recoverable from the contractor under the contract and if thereafter there remains any balance outstanding, it shall be recovered in accordance with the provisions of the contract.
- 33.7 In the event of the above course being adopted by the Engineer-in-Charge, the contractor shall have no claim to compensation for any loss sustained by him by reason of his having purchased or procured any materials or entered into any engagements or made any advance on any account or with a view to the execution of the work or the performance of the contract.

CLAUSE - 34: COMPLETION TIME AND EXTENSIONS

- 34.1 The Engineer-in-Charge will make available to the contractor the site to enable the contractor to commence & proceed with the execution of the work in accordance with agreed programme. If there is any delay in making available any area of the work or the delays mentioned in Para 34.4, the competent authority as specified in schedule 'B' on the recommendations of the Engineer-in-Charge shall grant reasonable extension of time for completion of work. But the contractor shall not claim any compensation whatsoever on this account.
- 34.2 If after the award of the work the contractor commits defaults in commencing the execution of work as aforesaid, Govt. shall without prejudice to any other right or remedy available in law, be at liberty to forfeit the earnest money & performance guarantee absolutely.
- 34.3 As soon as possible after the Contract is concluded, the Contractor shall submit a Time and Progress Chart get it approved by the Department. The Chart shall be prepared in direct relation to the time stated in the Contract documents for completion of items of the works. It shall indicate the forecast of the dates of commencement and completion of various trades of sections of the work.
- 34.4 However, if the work (s) be delayed by:-
- (i) Force majeure as per clause 27, or
 - (ii) Abnormally bad weather, or
 - (iii) Serious loss or damage by fire, or
 - (iv) Civil commotion, local commotion of workmen, strike or lockout, affecting any of the trades employed on the work, or
 - (v) Delay on the part of other contractors or tradesman engaged by Engineer-in-Charge in executing work not forming part of the contract, or
 - (vi) Non-availability of stores, which are the responsibility of Government to supply or
 - (vii) Non-availability of breakdown of Tools and Plant to be supplied or supplied by Government or
 - (viii) Any other cause which, in the absolute discretion of the Engineer-in-Charge is beyond the Contractor's control.

then immediately upon the happening of any such events as aforesaid, the contractor shall inform the Engineer-in-Charge accordingly, but the contractor shall nevertheless use constantly his best endeavours to prevent and/or make good the delay and shall do all that may be required in this regard. The Contractor shall also request, in writing, for extension of time, to which he may consider himself eligible under the contract, within fourteen days of the date of happening of any such events as indicated above.

- 34.5 In case the cost of the work is more than 10 crores, then the total scope of work will be divided into milestones. The contractor shall submit a Time & Progress chart for each milestone and get it approved by the competent authority.
- 34.6 Request for rescheduling of Mile stones and extension of time, to be eligible for consideration, shall be made by the Contractor in writing within fourteen days of the happening of the event causing delay on the prescribed form to the competent authority as indicated in Schedule 'B'. The Contractor may also, if practicable, indicate in such a request the period for which extension is desired.
- 34.7 In any such case as may have arisen due to any of the events, as aforesaid, and which may have been brought out by the contractor in writing, the Competent Authority mentioned in Scheduled 'B' may give a fair and reasonable extension of time, after taking into consideration the nature of the work delayed and practicability of its execution during the period of extension.
- 34.8 Such extensions shall be communicated to the contractor by the Engineer-in-Charge in writing. The contractor shall not be entitled to claim any compensation or over run charges whatsoever for any extension granted.

CLAUSE – 35: LIQUIDATED DAMAGES FOR DELAY

- 35.1 If the contractor fails to maintain the required progress in terms of clause 34 or to complete the work and clear the site on or before the date of completion as per the contract or extended date of completion, he shall, without prejudice to any other right or remedy available under the law to the authority on account of such breach, pay as agreed liquidated damages the amount calculated at the rates stipulated below.

- (i) Liquidated Damages @ 1.5 % per month of delay
for delay of work to be computed on per day basis

Provided always that the total amount of compensation for delay to be paid under this condition shall not exceed 10% of the Tendered Value of work.

The competent authority mentioned in Schedule 'B' (whose decision in writing shall be final & binding) may decide on the amount of tendered value of the work for every completed day/month (as applicable) that the progress remains below that specified in Clause 34 or that the work remains incomplete.

The amount of liquidated damages may be adjusted or set-off against any sum payable to the Contractor under this or any other contract with the authority.

- 35.2 In case of contracts having tendered amount more than 10 Crores, if the contractor does not achieve a particular milestone mentioned in Schedule 'B', or the re-scheduled milestone(s) in terms of Clause 34.6, the amount shown against that milestone shall be withheld, to be adjusted against the liquidated damages levied at the final decision on Extension of Time. With-holding of this amount on failure to achieve a milestone, shall be automatic without any notice to the contractor. However, if the contractor catches up with the progress of work on the subsequent milestone(s), the withheld amount shall be released. In case the contractor

fails to make up for the delay in subsequent milestone(s), amount mentioned against each milestone missed subsequently also shall be withheld. However, no interest, whatsoever, shall be payable on such withheld amount.

- 35.3 In case of contracts having tendered amount less than 10 Crores, if the work remains incomplete after the stipulated date of completion, the Engineer-in-charge may withheld 10% of the tendered value of the work from the running payments of the contractor pending final decision of the competent authority mentioned in schedule 'B' on the extension of time case. If the competent authority decides to grant extension of time without levy of liquidated damages or levy part of the total liquidated damages specified above then the balance withheld amount after adjusting the amount of the liquidated damages levied by the competent authority will be refunded to the contractor.

CLAUSE – 36: WHEN THE CONTRACT CAN BE DETERMINED

- 36.1 Subject to other provisions contained in this clause, the Engineer-in-Charge may, without prejudice to his any other rights or remedy against the contractor in respect of any delay, inferior workmanship, any claims for damages and/or any other provisions of this contract or otherwise, and whether the date of completion has or has not elapsed, by notice in writing absolutely determine the contract in any of the following cases:
- (i) If the contractor having been given by the Engineer-in-Charge a notice in writing to rectify, reconstruct or replace any defective work or that the work is being performed in an inefficient or otherwise improper or un-workman like manner shall omit to comply with the requirement of such notice for a period of seven days thereafter.
 - (ii) If the contractor has, without reasonable cause, suspended the progress of the work or has failed to proceed with the work with due diligence so that in the opinion of the Engineer-in-Charge he will be unable to secure completion of the work by the date for completion and continues to do so after a notice in writing of seven days from the Engineer-in-Charge.
 - (iii) If the contractor fails to complete the work within the stipulated date or items of work with individual date of completion, if any stipulated, on or before such date(s) of completion and does not complete them within the period specified in a notice given in writing in that behalf by the Engineer-in-Charge.
 - (iv) If the contractor persistently neglects to carry out his obligations under the contract and/ or commits default in complying with any of the terms and conditions of the contract and does not remedy it or take effective steps to remedy it within 7 days after a notice in writing is given to him in that behalf by the Engineer-in-Charge.
 - (v) If the contractor shall offer or give or agree to give to any person in IWAI service or to any other person on his behalf any gift or consideration of any kind as an inducement or reward for doing or forbearing to do or for having done or forborne to do any act in relation to the obtaining or execution of contract.
 - (vi) If the contractor shall enter into a contract with IWAI in connection with which commission has been paid or agreed to be paid by him or to his knowledge, unless the particulars of any such commission and the terms of payment thereof have been previously disclosed in writing to the Engineer-in-Charge.
 - (vii) If the contractor shall obtain a contract with IWAI as a result of wrong tendering or other non-bona-fide methods of competitive tendering or commits breach of integrity pact.
 - (viii) If the contractor being an individual, or if a firm, any partner thereof shall at any time be adjudged insolvent or have a receiving order or order for administration of his estate made against him or shall take any proceedings for liquidation or composition (other than a

voluntary liquidation for the purpose of amalgamation or reconstruction) under any Insolvency Act for the time being in force or make any conveyance or assignment of his effects or composition or arrangement for the benefit of his creditors or purport so to do, or if any application be made under any Insolvency Act for the time being in force for the sequestration of his estate or if a trust deed be executed by him for benefit of his creditors.

- (ix) If the contractor being a company shall pass a resolution or the court shall make an order that the company shall be wound up or if a receiver or a manager on behalf of accredit or shall be appointed or if circumstances shall arise which entitle the court or the creditor to appoint a receiver or a manager or which entitle the court to make a winding up order.
- (x) If the contractor shall suffer an execution being levied on his goods and allow it to be continued for a period of 21 days.
- (xi) If the contractor assigns, transfers, sublets (engagement of labour on a piece-work basis or of labour with materials not to be incorporated in the work, shall not be deemed to be subletting) or otherwise parts with or attempts to assign, transfer, sublet or otherwise parts with the entire works or any portion thereof without the prior written approval of the Engineer -in-Charge.

When the contractor has made himself liable for action under any of the cases aforesaid, the Engineer-in-Charge on behalf of the IWAI with the approval of the competent authority mentioned in schedule 'B' shall have powers:

- (a) To determine the contract as aforesaid (of which termination notice in writing to the contractor under the hand of the Engineer-in-Charge shall be conclusive evidence). Upon such determination, the Earnest Money Deposit, Security Deposit already recovered and Performance Guarantee under the contract shall be liable to be forfeited and shall be absolutely at the disposal of the IWAI.
- (b) After giving notice to the contractor to measure up the work of the contractor and to take such whole, or the balance or part thereof, as shall be un-executed out of his hands and to give it to another contractor to complete the work. The contractor, whose contract is determined as above, shall not be allowed to participate in the tendering process for the balance work.

In the event of above courses being adopted by the Engineer-in-Charge, the contractor shall have no claim to compensation for any loss sustained by him by reasons of his having purchased or procured any materials or entered into any engagements or made any advances on account or with a view to the execution of the work or the performance of the contract. And in case action is taken under any of the provision aforesaid, the contractor shall not be entitled to recover or be paid any sum for any work thereof or actually performed under this contract unless and until the Engineer-in-Charge has certified in writing the performance of such work and the value payable in respect thereof and he shall only be entitled to be paid the value so certified.

CLAUSE – 37: INSPECTION AND APPROVAL

- 37.1 All works involving more than one process shall be subject to examination and approval at each stage thereof and the contractor shall give due notice to the Engineer-in-Charge on his authorized representative, when each stage is ready. In default of such notice, the Engineer-in-Charge shall be entitled to appraise the quality and extent thereof and the decision of the Engineer-in-Charge in this regard shall be final and binding.
- 37.2 No work shall be put out of view without the approval of the Engineer-in-Charge or his authorized representative and the Contractor shall afford full opportunity for examination. The contractor shall give due notice to the Engineer-in-Charge or his authorized representative whenever any such work is ready for examination and the Engineer- in-Charge

or his representative shall, without unreasonable delay, unless he considers it necessary and advise the contractor accordingly, examine and measure such work. In the event of the failure or the contractor to give such notice, he shall if required by the Engineer-in-Charge, uncover such work at the contractor's expenses.

- 37.3 Periodic inspection will be carried out by the EIC or his representative by their vessels. The contractor can have the inspection schedules finalized with the Engineer-in-charge. Generally all attempts should be made to have joint inspection and number of inspections be not less than three in a calendar month.

CLAUSE – 38: COMPLETION CERTIFICATE AND COMPLETION PLANS

- 38.1 The work shall be completed to the entire satisfaction of the Engineer-in-Charge and within the specified time limit and under the terms and conditions of the contract. As soon as the work under the contractor is completed as a whole the contractor shall give notice of such completion to the Engineer-in-Charge. The Engineer-in-Charge shall inspect the work and shall satisfy himself that the work(s) has been completed in accordance with the provisions of the contract and then issue to the Contractor a certificate of completion indicating the date of completion. Should the Engineer- in-Charge notice that there are defects in the works or the works are not considered to be complete, he shall issue a notice in writing to the Contractor to rectify / replace the defective work or any part thereof or complete the work, as the case may be within such time as may be notified and after the contractor has complied with as aforesaid and gives notice of completion the Engineer-in-Charge shall inspect the work and issue the completion certificate in the same manner as aforesaid.
- 38.2.1 No certificate of completion shall be issued as stipulated above and no work be considered to be completed unless the contractor shall have removed from the work site and / or premises all his belongings / temporary arrangements brought / made by him for the site and / or premises in all respects and made the whole of the site and / or premises fit for immediate occupation / use to the satisfaction of the Engineer- in-Charge. If the contractor fails to comply with the above mentioned requirements on or before the date of completion of the work, the Engineer-in-Charge, may as he thinks fit and at the risk at cost of the contractor, fulfill such requirements and remove / dispose of the contractor's belongings / temporary arrangements, as aforesaid, and the contractor shall have no claim in this respect except for any sum realised by the sale of Contractor's belongings / temporary arrangements less the cost of fulfilling the said requirements and any other amount that may be due from the contractor. Should the expenditure on the aforesaid account exceed the amount realised by sale of such contractor's belongings / temporary arrangements then the contractor shall on demand pay the amount of such excess expenditure.
- 38.2.2 The contractor shall submit the completion plans of the work wherever required within 30 days of the completion of work. In case the contractor fails to submit completion plans as aforesaid, he shall be liable to pay a sum equivalent to 2.5% of the value of the work subject to a ceiling of Rs. 15000/- (Rupees fifteen thousand only) as may be fixed by Engineer-in-Charge concerned and in this respect the decision of the Engineer-in-Charge shall be final and binding on the contractor.

CLAUSE - 39: MEASUREMENTS

- 39.1 The Engineer-in-charge shall, except as otherwise provided, ascertain and determine by measurement the value of work done in accordance with the contract.
- 39.2 Notwithstanding any provision in the relevant standard method of measurement or any general or local custom, measurement of work done under the contract shall be taken in

accordance with the procedure set forth in the Technical Specifications or Schedule of Quantities under the contract. In case of items of work which are not covered by the Technical Specifications or Schedule of Quantities measurement shall be taken in accordance with the relevant standard methods of measurement laid down by the Bureau of Indian Standard.

- 39.3 All items having a financial value shall be entered in daily log book/ measurement book prescribed by the Authority so that the complete work performed under the contract is duly accounted.
- 39.4 Measurement shall be taken jointly by the Engineer-in-Charge or his authorised representative and by the contractor or his authorised representative.
- 39.5 Before taking measurements of any works, the Engineer-in-Charge or representative deputed by him for the purpose, shall give a reasonable notice to the Contractor. If the Contractor fails to attend or send an authorised representative for measurement after such notice or fails to countersign or to record the objection within a week from the date of taking the measurements, in such eventuality the measurements taken by the Engineer-in-Charge shall be taken to be correct and final measurements of such works.
- 39.6 The contractor shall, without extra charge, provide assistance with every appliance, labour and other things necessary for measurement.
- 39.7 Measurements shall be signed and dated by both parties each day on the Site on completion of measurement. If the contractor objects to any of the measurement recorded by the representative of the Engineer-in-Charge a note to the effect shall be made in the item objected to and such note shall be signed and dated by both parties engaged in taking the measurement. The decision of the Engineer-in-Charge on any such dispute or difference or interpretation shall be final and binding on the contractor in respect of all contract items, substituted items, extra items and deviations.

CLAUSE – 40: PAYMENT ON ACCOUNT

- 40.1 Interim bills shall be submitted by the contractor monthly on or before the date fixed by the Engineer-in-Charge for the items of work completed. The Engineer-in-Charge shall then arrange to have the bills verified with reference to the actual measurements recorded in the measurement book(s).
- 40.2 Payment on account for amount admissible shall be made by the Engineer-in-Charge certifying the sum to which the contractor is considered entitled by way of interim payment for the work executed, after deducting there from the amount already paid, the security deposit and such other amounts as may be withheld, deductible or recoverable in terms of the contract.
- 40.3 Payment of the contractor's bills shall be made by the Authority only in Indian Rupees within 30 days from the date of submission of the bill subject to the acceptance of the Engineer-in-Charge.
- 40.4 Payments due to the contractor shall be made by crossed cheque by the Engineer-in-Charge or his authorised representative. Such cheques shall be issued direct to the contractor on furnishing a stamped receipt for the amount of the cheque or to his constituted attorney duly authorised to receive such payments from the EIC. Alternatively payment, due to the contractor shall be made by electronic bank transfer / RTGS
- 40.5 Any interim certificate given relating to work done or materials delivered may be modified or corrected by any subsequent interim certificate or by the final certificate. No certificate(s) of

the Engineer-in- Charge supporting an interim payment shall itself be conclusive evidence that any work or materials to which it relates is / are in accordance with the same.

- 40.6 Should there be a request for extension of date of completion, pending its consideration interim payments shall continue to be made as provided herein.
- 40.7 Income Tax / TDS at the applicable rates shall be deducted at source from any payment made to the contractor against this contract.

CLAUSE – 41: TAXES, DUTIES AND LEVIES ETC.

The rates quoted by the bidder shall be deemed to be inclusive of all taxes, duties, cess, levies, etc. and also including 1% Labour Welfare Cess except for GST which shall be indicated and claimed separately. Labour Welfare Cess @ 1% of the value of the contract shall be deducted from the RA bills of the Contractor and deposited by IWAI as per norms of Govt. of India.

CLAUSE-42: TAX DEDUCTION AT SOURCE

- 42.1 TDS at the applicable rate as per Income Tax Act/Rules shall be deducted from all the payment/advances made against the contract.

CLAUSE – 43: PAYMENT OF FINAL BILL

The final bill shall be submitted by the contractor within one month from the date of completion of the work or of the date the certificate of completion furnished by the Engineer-in-Charge. No further claim in this regard unless as specified herein under shall be entertained. Payment of final bill shall be made within three months if the amount of the contract is up to Rs. 15 lakhs and six months if the value of the work exceeds Rs. 15 lakhs. If there shall be any dispute about any item or items of the work then the undisputed item or items only shall be paid within the said period of three months or six months, as the case may be. The contractor shall submit a list of the disputed items within thirty days from the disallowance thereof and if he fails to do so, his claim shall be deemed to have been fully waived and absolutely extinguished.

CLAUSE - 44: OVER PAYMENTS AND UNDER PAYMENTS

- 44.1 Whenever any claim whatsoever for the payments of a sum of money to the Authority arises out of or under this contract against the contractor, the same may be deducted by the Authority from any sum then due or which at anytime thereafter may become due to the contractor under this contract and failing that under any other contract with the Authority or from any other sum whatsoever due to the contractor from the Authority or from his security deposit, or he shall pay the claim on demand.
- 44.2 The Authority reserves the right to carry out post- payment audit and technical examination of the final bill including all supporting vouchers, abstracts, etc. The authority further reserves the right to enforce recovery of any over payment when detected notwithstanding the fact that the amount of the final bill may be included by one of the parties as an item of dispute before an arbitrator appointed under clause 48 of this contract and notwithstanding the fact that the amount of the final bill figures in the arbitration award.
- 44.3 If as a result of such audit and technical examination any over payment is discovered in respect of any work done by the contractor or alleged to have been done by him under contract, it shall be recovered by the Authority from the contractor by any of all of the

methods prescribed above, and if any under payment is discovered, the amount shall be duly paid to the contractor by the Authority.

- 44.4 Provided that the aforesaid right of the Authority to adjust over-payment against amount due to the contractor under any other contract with the Authority shall not extend beyond the period of two years from the date of payment of the final bill or in case the final bill is a MINUS bill, from the date the amount payable by the Contractor under the MINUS final bill is communicated to the contractor.
- 44.5 Any sum of money due and payable to the Contractor (including the security deposit returnable to him) under the contract may be withheld or retained by way of lien by the Engineer-in-Charge or Authority against any claim of the Authority or such other person or persons in respect of payment of a sum of money arising out of or under any other contract made by the contractor with the Engineer-in-Charge or Authority or with such other person or persons. The sum of money so withheld or retained under this clause by the Engineer-in-Charge or Authority will be kept withheld or retained as such by the Engineer-in-Charge or Authority or till his claim arising out of in the same contract or any other contract is either mutually settled or determined by the arbitrator, if the contract is governed by the arbitration clause under the clause 48 or by the competent court hereinafter provided, as the case may be, and the contractor shall have no claim for interest or damages whatsoever on this account or any other ground in respect of any sum of money withheld or retained under this clause.

CLAUSE – 45: FINALITY CLAUSE

It shall be accepted as an inseparable part of the contract that in matters regarding design, materials, workmanship, removal of improper work, interpretation of the contract drawings and contract specifications, mode of procedure and the carryout of the work the decision of the Engineer-in-Charge which shall be given in writing shall be final and binding on the contractor.

CLAUSE-46: SUM PAYABLE BY WAY OF COMPENSATION TO BE CONSIDERED IS REASONABLE WITHOUT PREFERENCE TO ACTUAL LOSS

All sum payable by way of compensation to the Authority under any of these conditions shall be considered as reasonable compensation without reference to the actual loss or damage sustained and whether or not damage shall have been sustained.

CLAUSE - 47: SETTLEMENT OF DISPUTES & ARBITRATION.

- 47.1 Except where otherwise provided in the contract, all questions and disputes relating to the meaning of the specifications, design, drawings and instructions here-in-before mentioned and as to the quality of workmanship or materials used on the work or as to any other question, claim, right, matter or thing whatsoever in any way arising out of or relating to the contract, design, drawings, specifications, estimates, instructions, orders or these conditions or otherwise concerning the works or the execution or failure to execute the same whether arising during the progress of the work or after the cancellation, termination, completion or abandonment thereof shall be dealt with as mentioned hereinafter:
- (i) If the contractor considers any work demanded of him to be outside the requirements of the contract, or disputes any drawings, record or decision given in writing by the Engineer-in-Charge on any matter in connection with or arising out of the contract or carrying out of the work, to be unacceptable, he shall promptly within 15 days of the receipt of decision from the

Engineer-in-Charge request the Director in writing through the Engineer-in-Charge for written instruction or decision. Thereupon, the Director shall give his written instructions of the decision within a period of one month from the receipt of the contractor's letter. However, this will not be reason for the stoppage of work.

- (ii) If the Director fails to give his instructions or decision in writing within the aforesaid period or if the contractor is dissatisfied with the instruction or decision of the Director, the contractor may, within 15 days of the receipt of Director's decision, appeal to the Chairman, IWAI who shall afford an opportunity to the contractor to be heard, if the latter so desires, and to offer evidence in support of his appeal. The Chairman, IWAI shall give his decision within 30 days of receipt of contractor's appeal. If the contractor is still dissatisfied with his decision, the contractor shall within a period of 30 days from receipt of the decision, give notice to the Chairman, IWAI for appointment of arbitrator on prescribed proforma as per Annex-6, failing which the said decision shall be final binding and conclusive and not referable to adjudication by the arbitrator.

47.2 Except where the decision has become final, binding and conclusive in terms of Sub Para 47.1 above, disputes or differences shall be referred for adjudication through arbitration by a sole arbitrator appointed by Chairman, IWAI.

47.3 Further, within thirty (30) days of receipt of such notice from either party, the Engineer-in-Charge of work at the time of such dispute shall send to the Contractor a panel of three persons preferably but not necessarily from the approved panel of arbitrators being maintained by Indian Council of Arbitration (ICA) and thereafter the Contractor within fifteen (15) days of receipt of such panel communicate to the Engineer-in-charge the name of one of the persons from such panel and such a person shall then be appointed as sole arbitrator by the Chairman, IWAI. However, the arbitrator so appointed shall not be an officer or the employee of Inland Waterways Authority of India.

Provided that if the Contractor fails to communicate the selection of a name out of the panel so forwarded to him by the Engineer-in-charge then after the expiry of the aforesaid stipulated period the Chairman, shall without delay select one person from the aforesaid panel and appoint him as the sole arbitrator.

47.4 The arbitrator to whom the matter is originally referred being transferred or vacating his office or being unable to act for any reason, then the Chairman IWAI shall appoint another person to act as sole arbitrator, such person shall be entitled to proceed with the reference from the stage at which it was left by the predecessor.

47.5 The award of the Arbitrator shall be final and binding. The Arbitrator shall decide in what proportion the Arbitrator's fees, as well as the cost of Arbitration proceeding shall be borne by either party.

47.6 The Arbitrator with the consent of the parties can enlarge the time, from, time-to-time to make and publish his award.

47.7 A notice of the existence in question, dispute or difference in connection with the contract unless served by either party within 30 days of the expiry of the defects liability period, failing which all rights and claim under this contract shall be deemed to have been waived and thus forfeited and absolutely barred.

47.8 The Arbitrator shall give reasons for the award if the amount of claim in dispute is Rs. 1,00,000/- and above.

- 47.9 The work under this Contract shall continue during Arbitration proceedings and no payments due from or payment by the Authority shall be withheld on account of such proceedings except to the extent which may be in dispute.
- 47.10 The Arbitration and Conciliation Act 1996 with any statutory modifications or re-enactment thereof and the rules made there under and being in force shall apply to the Arbitration proceedings under this clause.
- 47.11 The parties to the agreement hereby undertake to have recourse only to arbitration proceedings under for Arbitration Act 1996 and the venue of the arbitration proceeding shall be Noida/ New Delhi and the parties will not have recourse to Civil Court to settle any of their disputes arising out of this agreement except through arbitration.

NOTE: In case of contract with another Public Sector Undertaking, following Arbitration Clause shall apply: "Except as otherwise provided, in case of a contract with a public Sector Undertaking if at any time any question dispute or difference whatsoever arises between the parties upon or in relation to, or in connection with this agreement, the same shall be settled in terms of the Ministry of Industry, Department of Public Enterprises O.M No. 3/5/93-PMA dt.30.06.93 or any modifications / amendments thereof. "The arbitrator shall have the power to enlarge the term to publish the award with the consent of the parties provided always that the commencement or continuation of the arbitration proceeding shall not result in cessation or suspension of any of other rights and obligations of the parties of any payments due to them hereunder.

CLAUSE - 48: CLAIMS

- 48.1 The contractor shall send to the Engineer-in-Charge once in every month on account giving particulars, as full and detailed as possible of all claims for any additional payment to which the contractor may consider himself entitled and of all extra work or additional work ordered in writing and which has been executed during proceeding month.
- 48.2 No claim for payment of any extra work or expenses will be considered which has not been included in such particulars. The Engineer-in-Charge may consider payment for any such work or expense, where admissible under the terms of the Contract.
- 48.3 Any claim which is not notified in two consecutive monthly statements for the two consecutive months shall be deemed to have been waived & extinguished.

CLAUSE 49: INTEREST

No interest shall be payable on account due to the contractor against final bills or any other payment due under the contract.

PART – III

7. TECHNICAL SPECIFICATIONS AND SPECIAL CONDITIONS OF CONTRACT

TECHNICAL SPECIFICATION AND SPECIAL CONDITIONS OF CONTRACT

1. Introduction

Inland Waterways Authority of India (IWAI) is a statutory body under the Ministry of Ports, Shipping & Waterways, Govt. of India. The Authority has the principal objectives of development, maintenance and management of National Waterways in the country for shipping and navigation. The Kollam - Kottappuram (extended up to Kozhikkode) stretch of West Coast Canal along with Champakkara Canal and Udyogmandal Canal have been declared as National Waterway No.3. IWAI envisaged development of navigational channel of minimum 2.20 M depth and 32/38 m bottom width in narrow/wider reaches in West Coast Canal and mark the navigational channel for safe, efficient shipping & navigation.

2. Scope of work

Providing & fixing of rubber fenders and replacement of damaged/rusted chains and plates fitted with rubber fenders in various IWAI terminals, to arrest soil erosion at an estimated cost of Rs. 55.61 lakhs (exclusive of GST) as per the Specifications & Bill of Quantities enclosed with the tender document.

3. Duration of Work

All the works are to be completed in all respect to the satisfaction of Engineer-in-charge within a period of 06 (Six) months from the date of issue of work order.

4. Technical Specification

- 4.1 The work shall be inspected by the Engineer-in-Charge or his nominee from time to time and if there is any deviation or short fall noticed in quality, location, levels, lines etc., shall be rectified immediately by the contractor at his own cost to the satisfaction of the Engineer-in-Charge.
- 4.2 All materials to be used shall be of approved quality conforming to BIS standard.
- 4.3 Providing and fixing rubber fenders (Natural rubber, Harness 65 - 75 Shore A) for various terminal for berthing of vessels to terminal jetties along with replacing rusted chains / plates of existing rubber fenders including removal of old chains, refixing of the fenders with new chains, cost of chains / fittings / screws, bolt & nuts, labour charges etc., complete. The rate shall include supply of required size fender at site, labour charges etc., complete. (Cylindrical Fender 30 cm dia x 100 cm long & V - Type Fender 100 cm long). In case of various in specification (Size) as per direction of EIC will be final.
- 4.2.1 Supply & providing of 12mm thick zinc coated galvanized 1.10 M long for replacing of existing rusted chains to avoid loss of fenders due to breakage of rusted chains including providing & fixing of MS plates of 8 mm thick (size 0.10 x 0.10) and necessary hooking arrangements / nuts & bolts for fixing in to the water front portion of the jetty as per the directions of E-I-C. The rate shall include supply & fixing of rod & plate to RCC Jetty with fender, hire charges of welding & cutting machines for fixing of supporting plates & screws etc., complete.
- 4.5 Dismantling of cylindrical fenders at required terminals from its existing positions carefully for inserting new rods & plates and refixing of the same on its exact position by the help of suitable capacity Crane / JCB/any suitable method as per the direction of E-I-C. The rate shall include dismantling of old fenders by cutting & removal of existing rusted chains/plates with the help of gas cutter/cutting machine with proper support to prevent the fall of fender in to the canal etc., hire charges, operator wages, labour charges etc., complete.

- 4.6 Re-fixing of fenders at IWT terminals from its existing positions carefully for inserting new rods & plates and re-fixing of the same in exact position by the by the help of suitable capacity Crane / JCB as per the direction of E-I-C. The rate shall include removal of old chains, re-fixing of the available fenders with new chains, cost of chains / fittings / screws, bolt & nuts, labour charges etc., complete.
- 4.7 The contractor is required to quote his rate incorporating the cost of materials, transportation and labour charges etc. No extra payment shall be entertained towards this account.
- 4.8 The contractor is expected to visit the site and familiarise the nature of works involved and its safety measures required prior to quoting for the subject work. The Authority shall not take any responsibility on the risk part to the labour(s) engaged and responsibility for any accidents due to inadequate safety measures will be of the contractor.

5. **Special Conditions**

- 5.1 No mobilization charges will be paid to the Contractor.
- 5.2 No shifting charges will be paid to the Contractor for shifting the construction equipment and its accessories from one location to another or from one area to another.
- 5.3 The contractors shall be liable to rectify any defects noticed in his work for a period of six months from the date of completion of work, without any additional cost.
- 5.4 The contractor shall execute the work continuously and good progress throughout the contract period. The Contractor is liable to be terminated, if proportionate progress of the work is not achieved during the Contract period.
- 5.5 No idle time charges will be paid to contractor any account.
- 5.6 The Engineer-in-Charge or his representative will inspect, co-ordinate, measure and certify the construction works. He has the right to inspect the work and materials at any time during the contract period for which contractor or his authorized agent shall be available at the work site.
- 5.7 The right to award or split up work or to reject any or all the offers without assigning any reasons is reserved with the Authority.
- 5.8 **Payment:-** The Contractor will submit the bill to the Engineer-in-Charge, the interim bills (in duplicate) after satisfactory completion of works having minimum of Rs.20 lakhs bill value for the actual work done. For each stage of interim bill, the contractor will inform in writing for joint measurement for the completed items of work. Thereafter, the contractor will submit interim bill in duplicate as in the BOQ format. The same will be processed and payment will be released within 15 days through RTGS mode. The decisions taken by the Engineer-in-Charge on interim bills will be final and binding on the contractor.
- 5.9 If the contractor or any outside labour employed to work during execution of Contract, breaks or damages/ destroy any vessel, craft, net, fishing stakes etc., building, road, kerb, water pipe, fence, bund, wires, trees, crops, fruits, or cultivated ground during the period of Agreement, the same shall be made good by the Contractor at his own cost expenses or in default the IWAI may cause the same to be made good by other sources and deduct the expenses from any sums that may be then or at any time therefore may become due to the Contractor.
- 5.10 Item rate for the work of “Providing & fixing of rubber fenders and replacement of damaged/rusted chains and plates fitted with rubber fenders in various IWAI terminals” shall be as per the specification of the tender document and on the basis of the contract price. The rate quoted per number / unit, will squarely and totally include all the charges to be paid to the contractor by the Authority.

PART - IV

8. DRAWINGS AND ANNEXURES.

1.	Index Map of West Coast Canal	Enclosure.1	
2.	Cross sections of fenders	Enclosure.2	
3.	Format of Self Declaration by the Bidder	Annexure.1	
4.	Details of Past Experience of Contractor for Similar works / Marine works		Annexure.2
5.	Agreement Format	Annexure.3	
6.	Sample Form for Site Orders Book	Annexure.4	
6.	Proforma for Hindrance Register	Annexure.5	
8.	Notice for Appointment of Arbitrator	Annexure.6	

Index Map

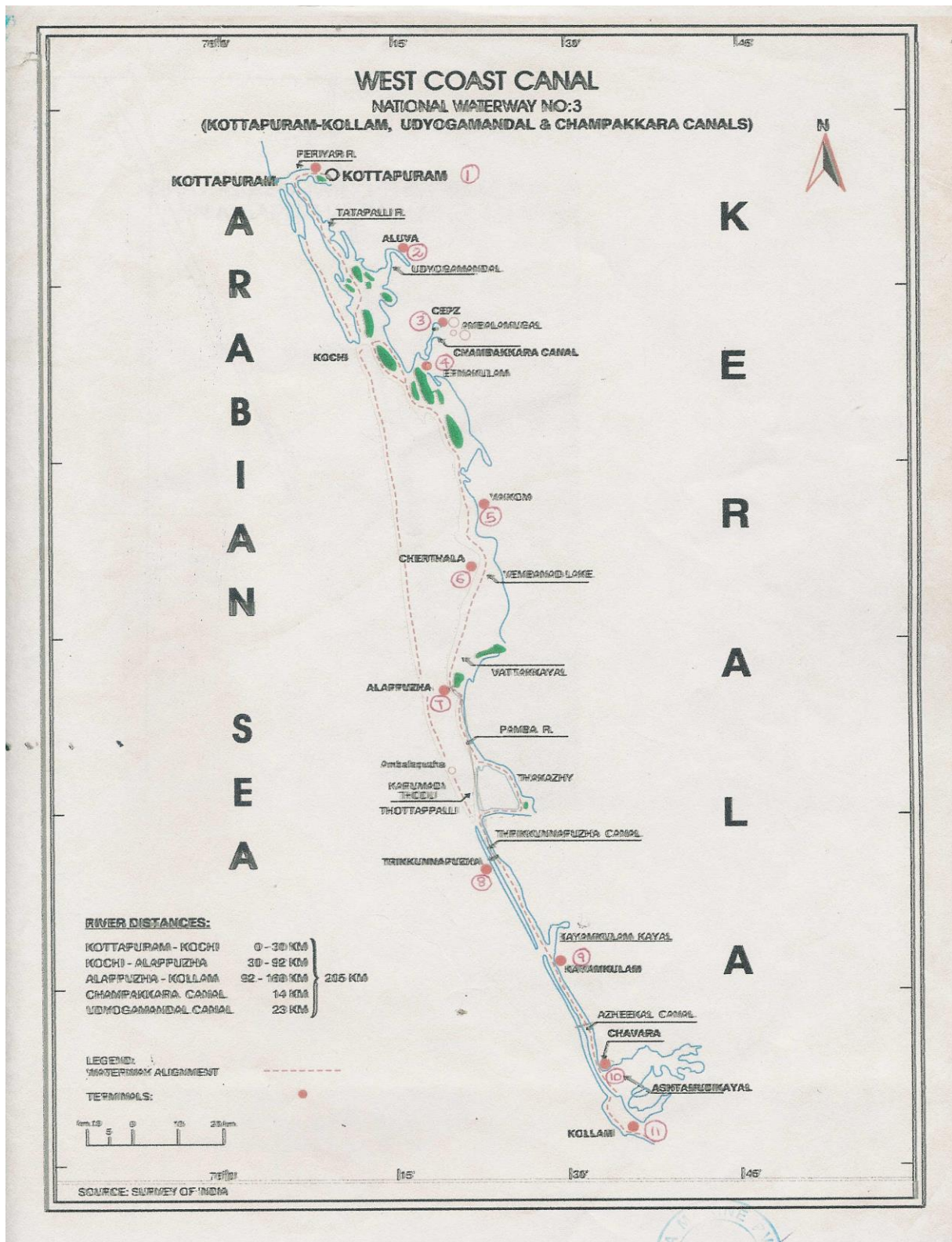

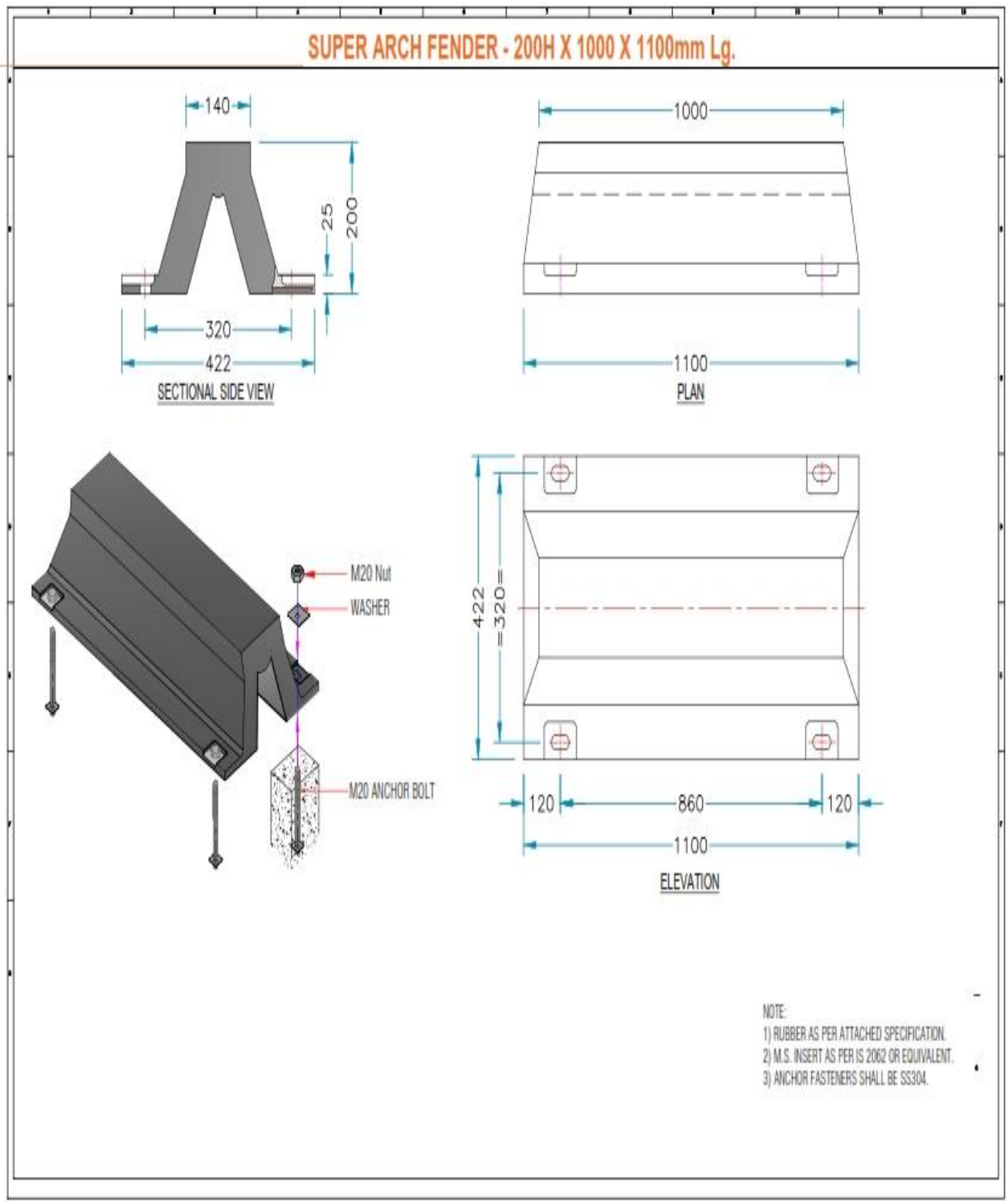

CYLINDRICAL FENDER O.D. 300 X I.D. 150 X 1000 MM LONG

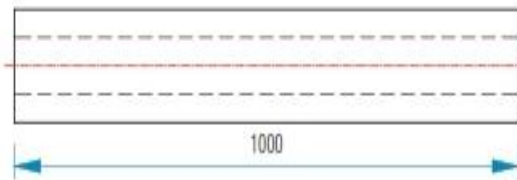

(1).CYC FENDER O.D.300XID.150 x 1 Mtr Lg.

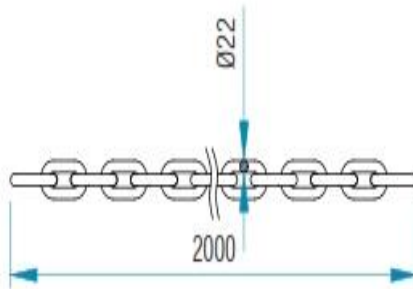
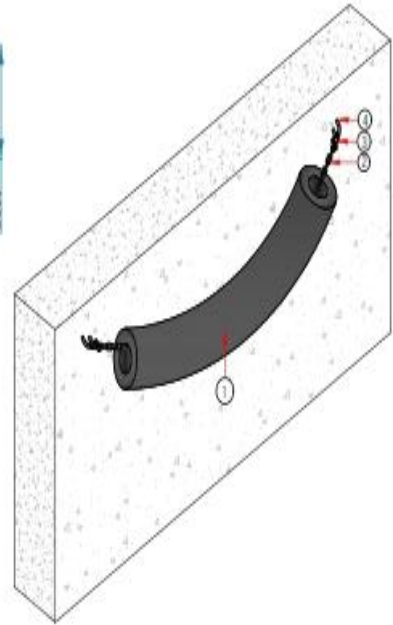
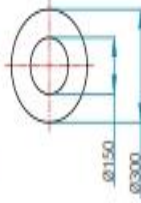

(2).CHAIN

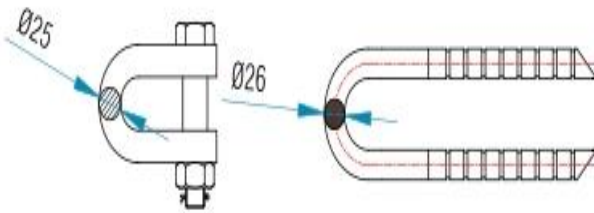

(3).D SHACKLE OF 25mm

(4).U-ANCHOR 26mm

BILL OF MATERIAL FOR ONE SET OF FENDERING SYSTEM

SR. NO.	DESCRIPTION	MATERIAL	UOM
01	CYLINDRICAL FENDER Ø300 X Ø150 X 1000 MM	RUBBER	01 NOS.
02	CHAINS DIA Ø22 X2000 L.g.	MS. HDG	01 NOS.
03	D-SHACKLE Ø25 MM	MS. HDG	02 NOS.
04	U-ANCHOR Ø26 MM	SS 410	02 NOS.

NOTE:-

- 1). RUBBER AS PER THE ATTACHED SPECIFICATION.
- 2). THE CHAIN & D SHACKLE SHALL BE OF MS. HDG GRB.B.

MV FENDER 500H X 1350L

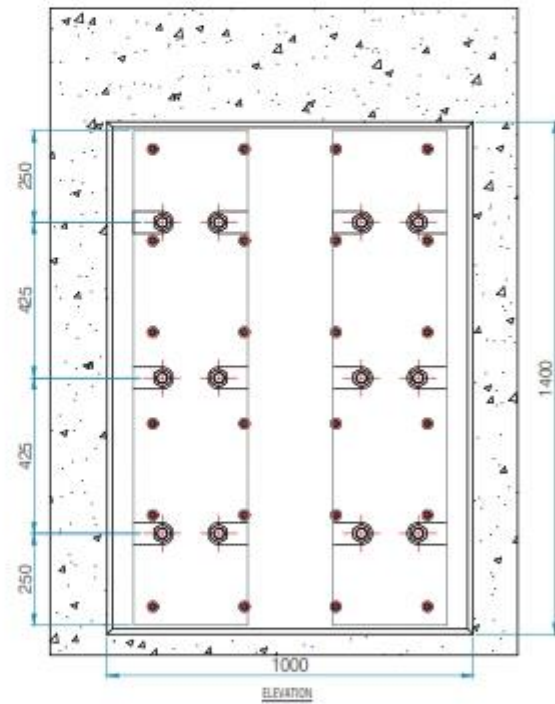
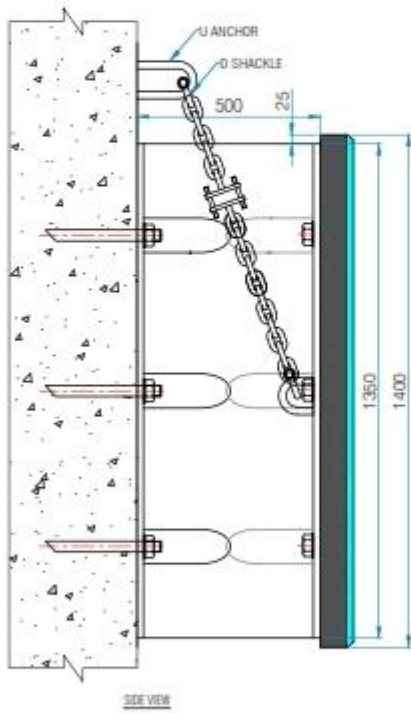
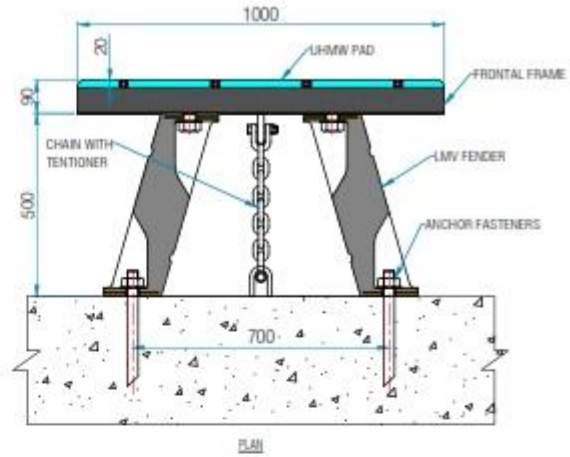

- NOTE:
- 1) RUBBER AS PER ATTACHED SPECIFICATION.
 - 2) M.S. INSERT AS PER IS 2062 OR EQUIVALENT.
 - 3) FRONTAL FRAME SHALL BE MS PAINTED.
 - 3) UHMW PAD SHALL BE BLACK COLOR.

DECLARATION BY THE BIDDERS
(To be submitted on the letter head of the Bidder)

To,

Date:.....

Director
Inland Waterways Authority of India
National Waterway Road, Kannadikkadu, Maradu,
Ernakulam, 682 304

Sub: Declaration from the Bidder**Tender Reference No:** IWAI/COCH/FEN/59/2024-25/32

Dear Sir,

This is with reference to the above mentioned Tender document.

We hereby make the following declarations:

1.	<input type="checkbox"/>	No alteration has been made in any form in the Tender document downloaded from the website of IWAI and e-procurement portal.
2.	<input type="checkbox"/>	I / We have not been debarred / blacklisted during the last three years
3.	<input type="checkbox"/>	I / We accept the payment terms of Terms of Reference.
4.	<input type="checkbox"/>	I / We provide our acceptance to all the Terms and Conditions of this tender document.
5.	<input type="checkbox"/>	I / We agree to disqualify us for any wrong declaration with respect to the submissions made by us for this tender and reject my/our tender summarily
6.	<input type="checkbox"/>	I / We agree to disqualify us from this tender and black list us for tendering in IWAI projects in future, if it comes to the notice of IWAI that the documents/submissions made by me/us are not genuine
7.	<input type="checkbox"/>	I / We confirm that I/we have noted / updated ourselves of all amendments / corrigendum / response to pre-submission queries etc. and bid is submitted incorporating the same.
8.	<input type="checkbox"/>	I / We have visited the site and familiar with the site conditions as well as proposed works.

Note: Please Tick the appropriate box in the above table.**Yours Faithfully****(Signature of the Bidder, with Official Seal)**

DETAILS OF PAST EXPERIENCE OF CONTRACTOR FOR SIMILAR WORKS / MARINE WORKS

(Bidder has to submit duly filled form in accordance with clause 4.1. (h) of instructions for submission of bid (page no.10)

Sl. No.	Name & Location of Project	Value of Work (in lakhs)	Particulars of Client	Duration of Contract			Details of Work
				Date of Commencement	Scheduled Completion Date	Actual Completion Date	

Note:

- (i) Bidders to enclose copies of work orders with respective completion certificates issued by the owner in chronological order within a period of last 7 years.
- (ii) If the table is not found spacious, bidder may kindly re-type form and submitted online.
- (iii) Incomplete work / Ongoing project will not be considered hence the same may not be included.

AGREEMENT FORMAT

This agreement made on day year between the Inland Waterways Authority of India (hereinafter called the 'IWAI' which expression shall unless excluded by or repugnant, to the context, be deemed to include heir, successors in office) on one part and M/s..... (hereinafter called the 'CONTRACTOR' which expression, shall unless excluded by repugnant to the context be deemed to include his heirs, executors, Administrators, representatives and assigns of successors in office) on the other part.

Whereas the IWAI is desirous of undertaking the work of "Providing & fixing of rubber fenders and replacement of damaged/rusted chains and plates fitted with rubber fenders in various IWAI terminals" WHEREAS the contractor has offered to execute and complete such works and WHEREAS IWAI has accepted the tender of the contractor and WHEREAS the contractor has furnished as Performance Security for the due fulfilment for all the conditions of this contract.

NOW IN THIS AGREEMENT WITNESSTH AS FOLLOWS

In this agreement words and expression shall have the same meaning as are respectively as assigned to them in the conditions of contract hereinafter referred to:

The following documents shall be deemed to form and be read and construed as part of this agreement Viz.,

- i) E-tender submitted by the Contractor including,
 - (a) Notice Inviting Tenders
 - (b) Tender form
 - (c) Information & instruction for Tenders
 - (d) Schedule : Bill of Quantity
 - (e) Drawings & Annexure's
 - (f) General Conditions of Contract and Technical specifications & Special Conditions of Contract
- ii) Correspondences between IWAI and the Contractor dated
- iii) Work order No.....dated.....
- iv) Any other / all other documents relevant for the Contract Agreement

The contract agreement has been compiled by the IWAI from the original tender documents and all the correspondences from the tendering stage till acceptance. In the event of any difference arising from the completion of the contract, the original tender documents, contractor's offer, minutes of meetings and correspondence between the parties ended vide letter no. may be referred to by either party. These documents shall take precedence over the compiled documents.

The contractor hereby covenants with the IWAI to complete and maintain the “Works” in conformity in all respect, with the provisions of the agreement.

The IWAI hereby covenants to pay the contractor in consideration of such completion of works, the contract price at the time and in the manner prescribed by the contract.

IN WITNESS WHEREOF the parties hereunto have set their hands and seals on the day year first written.

For and on behalf of

(Inland Waterways Authority of India)

For and on behalf of

Contractor

Signature _____

Signature _____

Name & Designation _____

Name & Designation _____

Stamp

Stamp

Witness:

Witness:

1) Signature _____

1) Signature _____

2) Name & Designation _____

2) Name & Designation _____

SAMPLE FORM FOR SITE ORDERS BOOK
(Reference Clause No. 18.4)

Name of work :

Date of commencement :

Period for completion :

Sl. No.	Date	Remarks of the Inspecting Officer or Contractor	Action taken and by whom	Remarks
1	2	3	4	5

PROFORMA FOR HINDRANCE REGISTER
(Reference Clause No. 18.5)

Sl. No	Nature of hindrance	Items of work that could not be due executed to this hindrance	Date of start of hindrance	Signature of Representative of EIC	Date of removal of hindrance	Overlapping period, if any	Net hindrance in days	Weightage of this hindrance	Net effective days of hindrance	Remarks of Engineer-in-Charge
1	2	3	4	5	6	7	8	9	10	11

Notice for appointment of Arbitrator
(Refer Clause 47)

To,

The Chairman, IWAI

.....
.....

Dear Sir,

In terms of Clause 47 of the Agreement, particulars of which are given below, I/we hereby give notice to you to appoint an arbitrator for settlement of disputed mentioned below:

1. Name of applicant
2. Whether applicant is Individual/Prop. Firm/Partnership Firm/Ltd. Co.
3. Full address of the applicant
4. Name of the work and contract number in which arbitration sought
5. Name of the Division which entered into contract
6. Contract amount in the work
7. Date of contract
8. Date of imitiation of work
9. Stipulated date of completion of work
10. Actual date of completion of work (if completed)
11. Total number of claims made
12. Total amount claimed
13. Date of intimation of final bill (if work is completed)
14. Date of payment of final bill (if work is completed)
15. Amount of final bill (if work is completed)
16. Date of request made to Director for decision
17. Date of receipt of Director's decision
18. Date of appeal made to Chairman, IWAI
19. Date of receipt of the decision of Chairman, IWAI

Specimen signatures of the applicant
(only the person/authority who
signed the contract should sign)

I/We certify that the information given above is true to the best of my/our knowledge. I/We enclose following documents.

1. Statement of claims with amount of claims
- 2.
- 3.

Yours faithfully
(Signatures)

Copy in duplicate to:

1. The Regional Director, IWAI

TENDER NO. IWAI/COCH/FEN/59/2024-25/32

PART – V

SCHEDULE OF QUANTITIES / FINANCIAL BID

Tender for
Providing & fixing of rubber fenders and replacement of
damaged/rusted chains and plates fitted with rubber
fenders in various IWAI terminals



JUNE 2024

भारतीय अन्तर्देशीय जलमार्ग प्राधिकरण
INLAND WATERWAYS AUTHORITY OF INDIA

(Ministry of Ports, Shipping and Waterways, Govt. of India)

(पत्तन, पोत परिवहन और जलमार्ग मंत्रालय, भारत सरकार)

National Waterway Road, Kannadikkadu, Maradu P.O,

NH 47 Bypass, Ernakulam, Kerala. PIN: 682 304.

E mail:- dirkoc.iwai@nic.in, Web Site:- www.iwai.nic.in

<https://eprocure.gov.in/eprocure/app>

Item Rate BoQ

Tender Inviting Authority: Inland Waterways Authority of India.

Name of Work: Providing & fixing of rubber fenders and replacement of damaged/rusted chains and plates fitted with rubber fenders in various IWAI terminals

Contract No: IWAI/COCH/FEN/59/2024-25/32

Bidder Name :

PRICE SCHEDULE

(This BOQ template must not be modified/ replaced by the bidder and the same should be uploaded after filling the relevant columns, else the bidder is liable to be rejected for this tender. Bidders are allowed to enter the Bidder Name and Values only)

NO.#	TEXT #	NUMBER #	TEXT #	NUMBER #	NUMBER #	TEXT #
Sl. No	Item Description	Quantity	Unit	RATE (incl. of 1% Labour Welfare Cess but exclusive of GST) Rs. P	AMOUNT	TOTAL AMOUNT In Words
1	2	3	4	5	6	7
1	Providing supply installation and fixing rubber fenders (Natural rubbre, Harness 65 - 75 Shore A) for various terminal for berthing of vessels to IWAI terminal jetties. The rate shall include the supply of required size of fender including fixing of the fenders with new chains, cost of chains / fittings / screws, bolt, D-shackle,U-Anchor & nuts, labour charges etc., complete. The work shall be excuted as per direction of EIC.					
1.1	V - Type Fender 100 cm long (Aluva & Maradu IWAI Terminal)	30.00	No			INR..... Only
1.2	Cylindrical Fender 30 cm dia x 100 cm long (Thrikunppuzha, Thannermukkom, Alappuzha, Vaikom IWAI Terminal)	60.00	No			INR..... Only
1.3	Element LMVI 500H * 1350 MM long * 2 pieces along with frontal frame. (Bolagatty Ro Ro Terminal)	5.00	No			INR..... Only

2.	Supply & providing of 12mm thick zinc coated galvanized chains of 1.10 M long for replacing of existing rusted chains to avoid lost of fenders due to breakage of rusted chains including removal of old chains, refixing of the available fenders with new chains, cost of chains / fittings / screws, bolt & nuts, labour charges etc., complete. The rate shall include supply of zinc coated GI chains of 12mm thick, hire charges of welding and cutting machines for fixing of supporting plates & screws etc.as per the directions of E-I.C, complete. (At Thrikunnappuzha, Alappuzha, Thannermukkom, Vaikom IWAI terminal)	20.00	No .			INR..... Only
3.	Lumpsum provision for removal and disposal of old fenders and materials should be kept in above terminal permises.as per the directions of E-I.C.	1	No			INR..... Only
Total in Figures Rs:						
Quoted Rate in Words	INR.....Only					

Signature:

Name & Address of the Bidder:

.....

.....