

*Providing Barbed wire fencing alongwith two nos entry & exit gate
at 120 acres of acquired land of ICLP at Sahibganj during 2022-23*

*Inland Waterways Authority of India,
(Ministry of Ports, Shipping & Waterways, Govt. of India),*



TENDER DOCUMENT

Providing Barbed wire fencing alongwith two nos entry & exit gate at 120 acres of acquired land of ICLP at Sahibganj during 2022-23



Tender No.: IWAI/KOL/8/SAHIBGANJ/2022-23

INLAND WATERWAYS AUTHORITY OF INDIA

(Ministry of Shipping, Road Transport & Highways, Govt. of India)

Head Office: A-13, Sector – 1, Noida-201 301 (U.P.)

Address of Issuing Office: P-78, GARDEN REACH ROAD, KOLKATA – 700 043

E-mail address of Issuing Officer : dirkol.iwai@nic.in

Web site: www.iwai.gov.in

<https://eprocure.gov.in/eprocure/app>

DISCLAIMER

1. This tender document is neither an agreement nor an offer by the Inland Waterways Authority of India (IWAI) to the prospective Bidders or any other person. The purpose of this tender document is to provide information to the interested parties that may be useful to them in the formulation of their Bid pursuant to this tender.
2. IWAI does not make any representation or warranty as to the accuracy, reliability or completeness of the information in this tender document and it is not possible for IWAI to consider particular needs of each party who reads or uses this tender document. This tender document includes statements which reflect various assumptions and assessments arrived at by IWAI in relation to the works. Such assumptions, assessments and statements do not purport to contain all the information that each Bidder may require. Each prospective Bidder should conduct its own investigations and analysis and check the accuracy, reliability and completeness of the information provided in this tender document and obtains independent advice from appropriate sources.
3. IWAI will not have any liability to any prospective Company / Firm / Consortium or any other person under any laws (including without limitation the law of contract, tort), the principles of equity, restitution or unjust enrichment or otherwise for any loss, expense or damage which may arise from or be incurred or suffered in connection with anything contained in this tender document, any matter deemed to form part of this tender document, the award of the Assignment, the information and any other information supplied by or on behalf of IWAI or their employees, any consultants or otherwise arising in any way from the selection process for the Assignment. IWAI will also not be liable in any manner whether resulting from negligence or otherwise however caused arising from reliance of any Bidder upon any statements contained in this tender document.
4. IWAI will not be responsible for any delay in receiving the Bids. The issue of this tender document does not imply that IWAI is bound to select a Bidder or to appoint the successful Bidder, as the case may be, for the works and IWAI reserves the right to accept / reject any or all of Bids submitted in response to this tender document at any stage without assigning any reasons whatsoever. IWAI also reserves the right to withhold or withdraw the process at any stage with intimation to all who submitted the Bid.
5. The information given is not an exhaustive account of statutory requirements and should not be regarded as a complete or authoritative statement of law. IWAI accepts no responsibility for the accuracy or otherwise for any interpretation or opinion on the law expressed herein.
6. IWAI reserves the right to change/modify/amend any or all provisions of this tender document. Such revisions to the tender document / amended Tender document will be made available on the e-procurement portal & website of IWAI.



Sl. No.	INDEX	Page no.
1.	Tender acceptance letter	4
2.	NIT publication	5
3.	Notice Inviting Tender	6-9
4.	Warranty Form	10
5.	Instruction for submission of bid	11-17
	Part-ITECHNICAL BID STANDARD FORMS	
6.	FORM 4A (Form of Tender)	19-20
7.	FORM 4B(Annual Average Turn over on C.A letter head)	21
8.	FORM 4C(Power of Attorney, in case if any)	22
9.	FORM 4D(Declaration by the bidders)	23
10.	FORM 4E(Bidders Information Sheet)	24
	Part-II GENERAL CONDITIONS	
11.	(i). Integrity Pact	26-30
12.	(ii). Schedules	31-32
13.	(iii). General conditions of contract	33-65
14.	(Part-IIITECHNICAL SPECIFICATIONS & SPECIAL CONDITIONS	66-67
	Part-IV	
15.	Bill of quantities	68-71
	Part-V	
16.	(i). Annexure I – Performa of agreement	72-73
	(ii). Annexure II – Performa for Performance Guarantee	74-75
	(iii). Annexure III – Performa for Site Order Book.	76
	(iv). Annexure IV – Performa for Hindrance Register.	77
	(v). Annexure V - Notice for appointment of Arbitrator	78
	(vi) Annexure VI – Details of Bank Account	79
17.	Drawings	80-84



TENDER ACCEPTANCE LETTER (To be given on Company Letter Head)

Date:

To,

Sub: Acceptance of Terms & Conditions of Tender.

Tender Reference No: _____

Name of Tender / Work: -

Dear Sir,

1. I/ We, have downloaded/ obtained the tender document(s) for the above mentioned 'Tender/ Work' from the web site(s) namely: www.iwai.nic.in OR <https://eprocure.gov.in/eprocure/app> as per your advertisement, given in the above mentioned website(s).
2. I/ We, hereby certify that I/ We, have read the entire terms and conditions of the tender documents from Page No.____ to ____ including all documents like annex(es), schedule(s), etc.), which form part of the contract agreement and I/ We, shall abide hereby by the terms/ conditions/ clauses contained therein.
3. The minutes of the pre-bid meeting and/ or corrigendum(s) issued from time to time by your department/ organization too have also been taken into consideration, while submitting this acceptance letter.
2. I/ We, hereby unconditionally accept the tender conditions of above mentioned tender document(s)/ minutes of the pre-bid meeting/ corrigendum(s) in it's totally/ entirety.
3. In case any provisions of this tender are found violated, then your department/ organization shall without prejudice to any other right or remedy be at liberty to reject this tender/ bid including the forfeiture of the full said earnest money deposit absolutely.

Yours Faithfully.

(Signature of the Bidder, with Official Seal)

**Providing Barbed wire fencing alongwith two nos entry & exit gate
at 120 acres of acquired land of ICLP at Sahibganj during 2022-23**

**Inland Waterways Authority of India,
(Ministry of Ports, Shipping & Waterways, Govt. of India),**

	INLANDWATERWAYS AUTHORITY OFINDIA, Ministry of Shipping, Govt. of India P-78, GARDEN REACH ROAD KOLKATA-700043 E-mail address of Issuing Officer:dirkol.iwai@nic.in
<p><u>E-Tender No: IWAI/KOL/8/SAHIBGANJ/2022-23</u> Inland Waterways Authority of India (IWAI) invites online bids/tenders from the experienced, reputed agency for “Providing Barbed wire fencing at 120 acres of acquired land of ICLP at Sahibganj during 2022-23. Details tender document can be downloaded from 27.09.2022 to 17.10.2022 from our web site www.iwai.nic.in and CPP portal web site https://eprocure.gov.in/eprocure/app. Last date of submission of bid: 17.10.2022 upto1500 hrs. Date of opening: 18.10.2022 at 15:30 hrs. For details please visit to IWAI website www.iwai.nic.in and CPP portal websitehttps://eprocure.gov.in/eprocure /app</p>	
<p>-sd- Director</p>	



INLAND WATERWAYS AUTHORITY OF INDIA

(Ministry of Shipping, Govt. of India)

P-78, GARDEN REACH ROAD, KOLKATA – 700043

E-mail address of Issuing Officer: dirkol.iwai@nic.in

Telephone Nos. 033-2439 0393

NOTICE INVITING TENDER No.: IWAI/KOL/8/SAHIBGANJ/2022-23

Name of Work: - Tender document for the work of Providing Barbed wire fencing alongwith two nos entry & exit gate at 120 acres of acquired land of ICLP at Sahibganj during 2022- 2023.

Inland Waterways Authority of India (IWAI) invites On line tenders in two cover system (Cover I - Technical bid and Cover II - Financial Bid) from reputed & experienced contractors for the work of Providing Barbed wire fencing alongwith two nos entry & exit gate at 120 acres of acquired land of ICLP at Sahibganj during 2022- 2023. The Bids will place online at <https://eprocure.gov.in/eprocure/app>. Tender document may be downloaded from the <https://eprocure.gov.in/eprocure/app>. as per the schedule as given in critical date sheet as under:-

1. Cost of the work, EMD requirement and Critical Dates are as under:-

Name of Works	Providing Barbed wire fencing alongwith two nos entry & exit gate at 120 acres of acquired land of ICLP at Sahibganj during 2022- 2023
Date of Publishing	27.09.2022
Document Download Start Date & Time	27.09.2022 14.00 Hrs
Bid Submission start Date & Time	27.09.2022 1600 Hrs
Bid Closing/Document Download End Date & Time	17.10.2022 1500 Hrs
Bid Opening Date & Time	18.10.2022 at 1530 Hrs
Estimated cost including all taxes, levies, cess, etc except GST as applicable.	Rs.51,22,107/-
EMD cost	Rs.1,02,442/-
Tender Cost	Rs.5900/- including GST

2. The tender document can be downloaded from the IWAI's website www.iwai.nic.in and CPP Portal Website <https://eprocure.gov.in/eprocure/app>. Bidders participating in e-tender process are required to deposit non-refundable Tender fee Rs.5900/- (Rupees five thousand nine hundred only) including GST towards the tender cost through RTGS/ NEFT in the following Account:

i.) Name of Bank Account:	IWAI FUND
ii.) Bank Name and Address	State Bank of India, Garden reach Branch, Kolkata
iii.)Bank Account Number	31661496517
iv.) IFSC	SBIN0001402
v.) MICR Code	700002126
vi) GST No. of IWAI	19AAATI7021F1ZV

The prescribed amount of EMD of this tender is also to be deposited through RTGS/ NEFT to the above account.

For exemption towards tender fee and EMD, the bidder should submit the valid certificate from Micro and Small Enterprise (MSEs) as defined in MSE Procurement Policy issued by Department of Micro Small and Medium Enterprise (MSME) or are registered with the central purchase organization or the concerned Ministry or Department or Startups as recognized by Department of Industrial Policy & Promotion(DIPP).

(NOTE: In the MSME/NSIC certificate the type of work shall be indicated or otherwise in the said situation the bid submitted by these types of bidders shall not be accepted)

3. A signed declaration stating that no alteration has been made in any form in the downloaded tender document is to be enclosed with the tender by the bidder
4. Tenderer shall agree to the terms & conditions of the tender and submit the tender online duly signed on each page for agreeing the same.
5. The complete bid as per the tender documents should be placed online at <https://eprocure.gov.in/eprocure/app> by **15.00hrs.** on **17.10.2022** and will be opened online on **18.10.2022** at **15.30 hrs** at IWAI, Regional Office, Kolkata. The original demand draft for tender fee and EMD should be deposited before closing date and time of submission of bid at Inland Waterways Authority of India, P-78, Garden Reach Road, Kolkata-700043 (WB) except Micro and Small Enterprises (MSEs) as defined in MSE Procurement Policy issued by Department of Micro, Small and Medium Enterprises (MSME) or Department or Startups as recognized by Department of Industrial Policy & Promotion (DIPP) on submission of a valid registration certificate as per the Government of India rules.
6. IWAI reserves the right to accept or reject any or all tenders without assigning any reason and no correspondence shall be entertained in this regard. The department will also have the right to award the work for different stretch to different bidders at the lowest received rate to ensure that the works are undertaken smoothly at all stretches simultaneously.
7. **Pre-Qualification Criteria:-**
 - i) The tenderer shall be registered with Central Public Works Department, Railways, MES and State PWD/ Irrigation Department or non-registered contractors having experience of working with IWAI.
 - ii) Tenderer shall have Permanent Account Number issued by Income Tax Deptt.
 - iii) The tenderer shall be registered with GST department and GST component shall be shown separately in the bill/invoice by the tenderer.
 - iv) Average annual financial turnover during last three years ending 31st March of the previous financial year, should be at least 30% of the cost of the work for each stretch as mentioned in this tender.
 - v) Average annual financial turnover during last three years ending of the previous financial year, should be at least 30% of the cost.
 - vi) Experience of having successfully completed similar works i.e. building construction, construction of approach road/ramp, Mooring Pins, construction of PCC road, surface dressing/clearance of jungle, construction of temporary security guard hut Barbed wire fencing, Barricading, Fabrication & Erection of gates at Govt. land, Construction other Civil Infrastructure work etc during the last 7 years ending last day of month previous to the one in which this tender is invited should be either of following for each stretch :
 - a) Three works costing not less than 50% of the estimated cost; or
 - b) Two works costing not less than 60% of the estimated cost; or
 - c) One work completed not less than 80% of the estimated cost

vii) Latest certificate of solvency from nationalized / scheduled Bank included in the second schedule of the RBI Act for not less than the value as indicated below:

Name of Work	Estimated Cost excluding GST (In Rs.)	Bank Solvency (Rs. in Lakh)
Providing Barbed wire fencing alongwith two nos entry & exit gate at 120 acres of acquired land of ICLP at Sahibganj during 2022- 2023	51,22,107.00	21.00

8. Bids shall be submitted online only at CPPP website [https://eprocure.gov.in /procure/app](https://eprocure.gov.in/procure/app) Manual bids shall not be accepted and liable to be rejected. The Hard copy of original instruments in respect of cost of tender document, earnest money, in original as asked in this tender document must be delivered at the office of Director, IWAI, P-78, GARDEN REACH ROAD, KOLKATA – 700043 **on or before bid opening date/time** as mentioned in critical date sheet. Late receipt of required document shall not be considered. Bidder shall likely to be liable for legal action for non-submission of original payment instrument like DD, etc., against the submitted bid. Demand Draft attached/submitted for tender fee shall be non refundable.

9. A signed declaration stating that no alteration has been made in any form in the downloaded tender document is to be enclosed with the tender by the bidder for downloaded tenders. Site can be inspected on all the working days during office hours. IWAI reserves the right to reject any or all the tender without assigning any reason thereof.

10. The firm may quote for work of indicated above and completed bids as per terms & Conditions mentioned in the tender document should be online submission at **<https://eprocure.gov.in/eprocure/app> upto 1500 hrs on 17.10.2022** and it will be opened on **18.10.2022 at 15:30 hrs.**

11. For special attention

- All tenderers are cautioned that tenders containing any deviation whatsoever from the terms and conditions, specifications as contained in the tender documents are liable to be rejected as non-responsive.

The tender shall have to be submitted bid online in two bid format, the first part i.e.” Technical bid” should contain the scanned copy of entire tender document duly signed in all places, details of machineries, technical manpower, work schedule, and earnest money deposit only but not the price bid. Second part i.e.” Financial bid” shall contain only the rates of the item of work as in schedule A. This price bid (BOQ of The work of Providing Barbed wire fencing alongwith two nos entry & exit gate at 120 acres of acquired land of ICLP at Sahibganj during 2022- 2023) as per format provided along with this tender. Bid shall be submitted online separate covers super scribing as “technical bid” and “financial bid”.

12. Earnest Money Deposit (EMD) and tender cost must accompany each tender and tender not accompanied by the EMD & tender cost shall be rejected as NON-RESPONSIVE. The EMD & tender cost for an amount as specified above shall be submitted in the technical bid.

13. Opening Of Tenders & Evaluation

- Tenders will be opened online by the tender evaluation committee at IWAI, Kolkata-700 043 at **15:30 hrs on 18.10.2022** in the presence of representative of the tenders who choose to remain present.
- After the online opening of the tenders, the first part i.e. Technical bid will be evaluated by the Tender Evaluation Committee as constituted by the Authority. The second part i.e. Price bid will be opened online by the same T.E.C. only for those tenderers who become technically qualified after the evaluation of technical on a suitable date.

- (c) **However, If the tendered amount quoted above than-15% (minus Fifteen Percent) than a rate analysis of tendered amount would have to be attached alongwith the tender document in online bid in technical packet for justification in relation to scope, schedule, resource mobilization, allocation of risks and responsibilities, and other requirements of the bid document during evolution of price bid. If the same is not submitted, due to any reasons whatsoever, price bid submitted by these types of bidder will not be accepted.**
- (d) If the tendered amount is same for more than one bidders then the work will be awarded to the bidder on the basis having more credential/experience certificate submitted by the bidders.

14 TENDER VALIDITY PERIOD

- a) The tender shall remain valid for a period not less than 120 days after the date of opening of tenders.
- b) Tenderer must read “ Information & Instruction for Tenders” and be satisfied himself in respect to scope and the situation of works or any issue as related to the work as considered necessary before the submission of the tenders.

15 The authority shall have the right to reject any or all the tenders and will not be bound to accept the lowest or any other offer.

16 The original EMD and tender cost instrument should reach the office of Director, Inland Waterways Authority of India, P-78, Garden Reach Road, Kolkata – 700 043, on or before date & time of opening of tender mentioned in the critical sheet otherwise the bid shall not be considered. The technical bid will be opened on **18.10.2022 at 15.30 hrs** in the presence of intending bidders.

17 IWAI reserves the right to accept or reject any or all tenders without assigning any reason and no correspondence shall be entertained in this regard.

(Director)

WARRANTY FORM

M/s..... having registered office at..... (herein after referred to as the contractor) having carefully studied all the documents, specifications, designs, drawings etc. pertaining to the contract for works required for the work ofand the local and site conditions and having under taken to execute the said works.

DO HEREBY WARRANT THAT

1. The contractor is familiar with all requirements of the contract.
2. The contractor has investigated the site and satisfied himself regarding the character of the work and local conditions that may affect the work or its performance.
3. The contractor is satisfied that the work can be performed and completed as required in the contract.
4. The contractor accepts all risks directly or indirectly, connected with the performance of the contract.
5. The contractor has no collusion with other contractors, with any of the men of the Engineer In-Charge or with any other person in the Authority to execute the said works according to the terms and conditions of the said contract.
6. The contract has not been influenced by any statement or promise of the Authority or Engineer-In-Charge but only by the contract documents.
7. The contractor is financially solvent.
8. The contractor is experienced and competent to perform the contract to satisfaction of the Engineer In-Charge
9. The statement submitted by the contractor is true.
10. The contractor is familiar with all general and special laws, Acts, Ordinance, Rules& Regulation of the Municipalities, District, State and Central Government that may affect the works, its performance or personnel employed herein or environment.

Date:.....
contractor

For and on behalf of the

Signature:

Name:.....

Instructions to the Consultants/Bidders for the e-submission of the bids online through the Central Public Procurement Portal for e-Procurement <https://eprocure.gov.in/eprocure/app>

- 1) Possession of valid Digital Signature Certificate (DSC) and enrollment/registration of the consultants/bidders on the e-procurement/e-tender portal is a prerequisite for e-tendering.
- 2) Bidder should do the enrollment in the e-Procurement site using the <https://eprocure.gov.in/eprocure/app> option available "Enroll Here" on the home page Portal. Enrollment is free of charge. During enrollment/registration, bidders should provide the correct/true information including valid email-id. All the correspondence shall be made directly with the contractors/bidders through email-id provided.
- 3) Bidder need to login to the site through their user ID/ password chosen during enrollment/registration.
- 4) Then the Digital Signature Certificate (Class II or Class III Certificates with signing key usage) issued by SIFY/TCS/nCode/eMudra or any Certifying Authority recognized by CCA India on eToken/SmartCard, should be registered.
- 5) The DSC that is registered only, should be used by the bidder and should ensure safety of the same.
- 6) Consultant/Bidder may go through the tenders published on the site and download the required tender documents/schedules for the tenders he/she is interested in.
- 7) After downloading / getting the tender document/schedules, the Bidder should go through them carefully and then submit the documents as asked.
- 8) If there are any clarifications, this may be obtained online through the tender site, or through the contact details. Bidder should take into account of the corrigendum published before submitting the bids online.
- 9) Bidder then logs in to the site through the secured log in by giving the user id/ password chosen during enrolment/registration and then by giving the password of the e-Token/SmartCard to access DSC.
- 10) Bidder selects the tender which he/she is interested in by using the search option & then moves it to the 'my favourites' folder.
- 11) From the favourites folder, he selects the tender to view all the details indicated.
- 12) It is construed that the bidder has read all the terms and conditions before submitting their offer. Bidder should go through the tender schedules carefully and upload the documents as asked, otherwise, the bid will be rejected.
- 13) Bidder, in advance, should get ready the bid documents to be submitted as indicated in the tender document/schedule and generally, they can be in general PDF/xls/rar/jpg formats. If there is more than one document, they can be clubbed together and can be provided in the requested format. Each document to be uploaded through online for the tenders should be less than 2 MB. If any document is more than 2MB, it can be reduced through zip/rar and the same can be uploaded, if permitted.

- 14) If there are any clarifications, this may be obtained through the site, or during the pre-bid meeting if any. Bidder should take into account the corrigendum published from time to time before submitting the online .
- 15) The Bidders can update well in advance, the documents such as certificates, annual report details etc., under My Space option and these can be selected as pertender requirements and then send along with bid documents during bid submission. This will facilitate the bid submission process faster by reducing upload time of bids.
- 16) Bidder should submit the Tender Fee/ EMD as specified in the tender. The original payment instruments should be posted/couriered/given in person to the Tender Inviting Authority within the due date as mentioned in this tender document. Scanned copy of the instrument should be uploaded as part of the offer, if asked for.
- 17) While submitting the bids online, the bidder reads the terms & conditions and accepts the same to proceed further to submit the bid packets.
- 18) The bidder has to select the payment option as offline to pay the Tender FEE/EMD as applicable and enter details of the instruments.
- 19) The details of the DD/any other accepted instrument, physically sent, should tally with the details available in the scanned copy and the data entered during bid submission time. Otherwise submitted bid will not be acceptable.
- 20) The bidder has to digitally sign and upload the required bid documents one by one as indicated. Bidders to note that the very act of using DSC for downloading the bids and uploading their offers shall be deemed to be a confirmation that they have read all sections and pages of the bid document including General conditions of contract without any exception and have understood the entire document and are clear about the requirements of the tender requirements.
- 21) The bidder has to upload the relevant files required as indicated in the cover content. In case of any irrelevant files, the bid will be rejected.
- 22) If the price bid format is provided in a spread sheet file like BoQ_xxxx.xls, the rates offered should be entered in the allotted space only and uploaded after filling the relevant columns. The Price Bid/BOQ template must not be modified/replaced by the bidder, else the bid submitted is liable to be rejected for this tender.
- 23) The bidders are requested to submit the bids through online e-tendering system to the Tender Inviting Authority (TIA) well before the bid submission end date & time (as per Server System Clock). The TIA will not be held responsible for any sort of delay or the difficulties faced during the submission of bids online by the bidders at the eleventh hour.
- 24) After the bid submission, the acknowledgement number, given by the e-tendering system should be printed by the bidder and kept as a record of evidence for online submission of bid for the particular tender and will also act as an entry pass to participate in the bid opening date.
- 25) The bidder should ensure/see that the bid documents submitted should be free from virus and if the documents could not be opened, due to virus, during tender opening, the bid is likely/liable to be rejected.
- 26) The time settings fixed in the server side & displayed at the top of the tender site, will be valid for all actions of requesting, bid submission, bid opening etc., in the e-tender system. The bidders should follow this time during bid submission.
- 27) All the data being entered by the bidders would be encrypted using PKI encryption techniques to ensure the secrecy of the data. The data entered will not be viewable by unauthorized persons during bid submission & not be viewable by any one until the time of bid opening.

- 28) Any bid document that is uploaded to the server is subjected to symmetric encryption using a system generated symmetric key. Further this key is subjected to asymmetric encryption using buyers/bid openers public keys. Overall, the uploaded tender documents become readable only after the tender opening by the authorized bid openers.
- 29) The confidentiality of the bids is maintained since the secured Socket Layer 128 bit encryption technology is used. Data storage encryption of sensitive fields is done.
- 30) The bidder should logout of the tendering system using the normal logout option available at the top right hand corner and not by selecting the (X) exit option in the browser.
- 31) Any queries relating to the tender document and the terms and conditions contained therein should be addressed to the Tender Inviting Authority for a tender or the relevant contact person indicated in the tender.

Any queries relating to the process of online bid submission or queries relating to CPP Portal in general may be directed to the 24x7 CPP Portal Helpdesk. The contact number for the helpdesk is 1800 233 7315



INLAND WATERWAYS AUTHORITY OF INDIA
(Ministry of Shipping, Road Transport & Highways; Govt. of India)

INSTRUCTIONS FOR SUBMISSION OF BID

1.0 All covering letters and information to be included in the bid shall be submitted along with the bid itself.

2.0 This tender schedule is only for the work of “Providing Barbed wire fencing alongwith two nos entry & exit gate at 120 acres of acquired land of ICLP at Sahibganj during 2022-23”.

3.0 Stretch wise total estimated cost of works is as under :

Sl. no.	Particulars	Estimated cos (in Rs lakhs)
1	Providing Barbed wire fencing alongwith two nos entry & exit gate at 120 acres of acquired land of ICLP at Sahibganj during 2022-23.	51.22

4.0 Tender should be submitted online at <https://eprocure.gov.in/eprocure/appby> -upto 1500hours on 17.10.2022 **in two bid system i.e.**

Folder -1 : Technical & Commercial Bid.

Folder-2 : Price Bid of offer.

The Technical & Commercial Bid and Price Bid of offer and will be opened online on 18.10.2022 at 1530 hours at IWAI, P-78, Garden Reach Road, Kolkata-700043

No other document other than the Price schedule should be placed inside Envelope – 2 containing price bid otherwise tender will be summarily rejected.

Technical Bid:

The technical bid shall be submitted online along with scanned copy of the following documents Original Bid document duly completed in all respect except prices and signed with seal on every pages,

- Bid document marked original duly completed and signed on every page except prices.
- Blank Performa of Schedule of Prices (prices not to be filled)
- Registered with Central Public Works Department, Railways, MES and State PWD/ Irrigation Department or non-registered contractors having experience of working with IWAI
- 'Tender Acceptance Letter' duly signed and stamped.
- 'Form of Tender' duly signed and stamped.
- Demand draft for the cost of the bidding documents must be uploaded. The original demand draft is to be deposited in the office before the bid opening date & time.

- g) Earnest Money Deposit/Tender Cost (Demand Draft/RTGS/NEFT as prescribed) or valid exemption certificate with respect work issued by any Govt. organization. As stated Scanned copy of same must be uploaded. The original demand draft may be deposited in the office before the bid submission closing date & time.
- h) Experience certificate for similar works completed by the Contractor(i.e Work completion/Payment certificate alongwith the work order).
- i) Latest Bank Solvency certificate (Not later than one year from the last date of submission this tender).
- j) Letter of Authority for signing and negotiation of tender (as the case may be).
- k) GST registration certificate from the concern Authority.
- l) Duly signed Integrity Pact (given in Part-II, General Conditions).
- m) Permanent Account Number (PAN) issued by Income Tax Department.
- n) Audited balance sheets along with turnover, profit and loss account for the last 3 years i.e. ending March 2019, 2020 & 2021
- o) A signed declaration stating that no alteration has been made in any form in the downloaded tender document is to be enclosed with the tender by the bidder for downloaded tenders.
- p) The bidder shall give a declaration that they have not been banned or black-listed by any Govt. or Quasi Govt. Agency or Public Sector Undertaking (PSU).
- q) All FORM as prescribed & as per terms condition in the same format to be submitted by bidder(4A, 4B, 4C, 4D & 4E)
- r) In addition to the above, the contractor is required to submit scanned copy of other document if any to full fill all the condition of the tender document and the same may be attached after thoroughly read/study failing which he will be treated as technically disqualified.

Note: Non submission of any of the above documents shall lead to disqualification of the bid.

Price Bid:

The price bid shall be submitted online for

- (i) Schedule of Prices duly filled in the specified form, i.e. "SCHEDULE –A etc." (whichever is relevant).
- (ii) If the bidder have not quoted price of any item than the same item shall be treated as zero cost and the bidder will be executed the same item obligatory as applicable as per tender.
- (iii) It may please be noted that this part shall not contain any terms & conditions. Any condition given in the price bid will be a sufficient cause for rejection of bid.

5.0 Bidders are advised to submit quotation strictly based upon technical specification, terms and conditions contained in technical specifications, terms and conditions contained in documents and not to stipulate any deviations. Any change in this may lead to rejection of bid.

6.0 Earnest Money Deposit separately for each stretch as indicated against stretch in NW-1 in the Notice inviting tender should be submitted by Demand Draft drawn in favour of "IWAI-Fund" payable at KOLKATA on any Nationalized/ Scheduled Bank of India for each stretch. The original demand draft for tender fee and EMD should be deposited before closing date and time of submission of bid at IWAI, P-78,Garden Reach Road, Kolkata-700043. In case the EMD

and tender fee is not reached the Office of inviting Officer before submission date and time of the bid, the bid is liable for rejection.

7.0 In case the purchaser of the tender document decide not to quote for this work, then the complete set of bid document may kindly be returned to the IWAI.

8.0 The bids can only be submitted in the name of the bidder in whose name the bid documents were issued by the IWAI.

9.0 Any annotations or accompanying documentation in the bid shall be in Hindi or English language only and in metric system. Tenders filled in any other language will be summarily rejected.

10.0 Bidders shall sign their proposal with the exact name of the firm to whom the bid document has been issued. The bid shall be duly signed and sealed by an authorized person of the bidder's organization as following:

10 (a) If the Tender is submitted by an individual, it shall be signed by the proprietor above his full name and full name of his firm with its current business address.

10 (b) If the Tender is submitted by the proprietary firm, it shall be signed by the proprietor above his full name and full name of his firm with its name and current business address.

10 (c) If the Tender is submitted by a firm in partnership, it shall be signed by all the partners of the firm above, their full names and current business address, or by a partner holding the power of attorney for the firm for signing the Tender in which cases a certified copy of the power of attorney shall accompany the Tender. A certified copy of the partnership deed and current business address of all the partners of the firm shall also accompany the Tender.

10 (d) If the Tender is submitted by a limited company, or a limited Corporation, it shall be signed by a duly authorized person holding the power of attorney for signing the tender in which case a certified copy of the power of attorney shall accompany the Tender. Such limited company or corporation may be required to furnish satisfactory evidence of its existence before the contract is awarded. 'Satisfactory evidence' means the certificate of incorporation of the limited company or corporation under Indian Companies Act, 1956.

10 (e) If the Tender is submitted by a group of firms, the sponsoring firm shall be submit complete information pertaining to each firm in the group and state along with the bid as to which of the firm shall have the responsibility for tendering and for completion of the contract document and furnish evidence admissible in law in respect of the authority assigned to such firm on behalf of the group of firms for tendering and for completion of the contract document. The full information and satisfactory evidence pertaining to the participation of each member of the group of firm in the firm in the Tender shall be furnished alongwith the Tender.

10 (f) All witnesses and sureties shall be persons of status and their full names, occupations and addresses shall be stated below their signatures. All signatures affixed in each page in the tender will be dated.

11.0 Bidders shall clearly indicate their legal constitution and the person signing the tender shall state his capacity and also the source of his ability to bind the bidder. The power of attorney or authorization or any other document constituting adequate proof of the ability of the signatory to bind the bidder shall be annexed to the bid. The Owner may reject outright any bid unsupported by adequate proof of the signatory's authority.

12.0 The bid document shall be completed in all respects and shall be submitted together with the requisite information and appendices. They shall be complete and free from ambiguity, change or inter-lineation. In case IWAI requires any information/ clarification(s) from the Bidder in respect of the bid documents, the bidder shall be required to furnish the same in writing, to IWAI at the earliest where no time is specified by IWAI to furnish the same. A failure to furnish the same shall entitle IWAI to cancel/ reject the bid.

13.0 If the space in the bid form or in the Appendices thereto is insufficient, additional pages shall be separately added. These pages shall be consecutively page numbered and shall also be signed by the Bidder.

14.0 Bidders should indicate at the time of quoting against this bid their full postal addresses, telephone numbers and other communication details enabling IWAI to contact the bidder in case the need so arise.

15.0 IWAI shall have a unqualified option under the said bid bond to claim the amount there under in the event of the Bidder failing to keep the bid valid up to the date specified or refusing to accept work or carry it out in accordance with the bid if the IWAI decides to award the Work to the Bidder.

16.0 The EMD shall be retained with the IWAI until finalization of tenders. Further, security deposit as per the clause of Security shall be payable by the successful bidder. If the tenderer fails to furnish the security deposit in accordance with tender conditions EMD shall be forfeited. In the event of the Bidder becoming the successful Contractor. The amount of EMD would be adjusted against the Security deposit.

17.0 IWAI shall, however, arrange to release the EMD in respect of unsuccessful bidders within 30 (thirty) days of placement of order to successful bidder. No interest shall be payable on EMD by IWAI.

18.0 The Tender Evaluation Committee (TEC) shall open the tenders in the presence of the intending tenderers who may be present at the date and time of opening informed in the bid document or subsequently. If any of the tenderer or his agent is not present at the time of opening of tender, the TEC shall, on opening of tenders of the absentee tenderer, prepare a statement of the attested and unattested corrections in the tender over their signature. Such a list shall then be binding on the absentee tenderer.

19.0 The successful tenderers shall be required to execute a contract agreement in the given format. In case of any refusal/ failure on the part of such successful tenderer to execute such a contract shall be deemed to be a failure on the part of such successful bidder to comply with the terms contained herein.

20.0 IWAI reserves the right to reject any or all bids without assigning any reasons.

PART I: TECHNICAL BID STANDARD FORMS

FORM 4A

FORM OF TENDER

To,

THE DIRECTOR
INLAND WATERWAYS AUTHORITY OF INDIA,
P-78, Garden Reach Road
Kolkata – 700 043

Name of Work: Providing Barbed wire fencing alongwith two nos entry & exit gate at 120 acres of acquired land of ICLP at Sahibganj during 2022-23.

1. Having visited the site and examined the information and instructions for submission of tender, general conditions of contract, Special Condition of contracts, Technical, General and Detailed specification, Schedules and Bill of Quantities, agreement and bank guarantee forms, etc for the above named works, I/ We hereby tender for execution of the works referred to in the tender documents in conformity with the said Conditions of Contract, Specifications, Schedule of quantities for the sum as stated in Bill of quantities of this tender Document or such other sum as may be ascertained in accordance with the said conditions of contract.
2. I/ We undertake to complete and Deliver the whole of the works comprised in the Contract within the time as stated in the tender and also in accordance in all respects with the specifications, designs, drawings and instructions as mentioned in the tender documents.
3. I am tendering for the works mentioned in the table below and submitting the EMD separately for each stretch of National waterway in the form of demand draft in favor of IWAI Fund payable at Kolkata at Nationalized / schedule bank as per the details given therein:

Sl. No	Particulars	Demand draft No. & Date	EMD (Rs.)	Details of Bank (Name of Bank, Branch and address)
1	Providing Barbed wire fencing alongwith two nos entry & exit gate at 120 acres of acquired land of ICLP at Sahibganj during 2022-23		Rs.1,02,422/-	

4. I/ We agree to abide by this tender. I/ We agree to keep the tender open for a period of 120 days from the date of opening of price bids or extension thereto as required by the IWAI and not to make any modifications in its terms and conditions.
5. I/ We agree, if I/ we fail to keep the validity of the tender open as aforesaid or I/ we make any modifications in the terms and conditions of my/ our tender if I/ We fail to commence the execution of the works as above, I/ We shall become liable for forfeiture of my/ our Earnest money, as aforesaid and IWAI shall without any prejudice to another right or remedy, be at the liberty to forfeit the said Earnest Money absolutely otherwise the said earnest money shall be retained by IWAI towards part of security deposit to execute all the works referred to in the tender documents upon the terms and conditions contained or referred to therein and to carry out such deviations as may be ordered. Should this tender be accepted, I/ We agree to abide by and fulfill all the terms and conditions and provisions of this tender. No interest is payable on earnest money deposit and/ or security deposit.
6. I/ We have independently considered the amount of Liquidated Damages shown in the tender hereto and agree that it represents a fair estimate of the loss likely to be suffered by IWAI in the event of works not being completed in time.
7. If this tender is accepted, I/ We undertake to enter into execute at my/ our cost when called upon by the employer to do so, a contract agreement in the prescribed form. Unless and until a formal Agreement is prepared and executed this tender together with your written acceptance thereto shall constitute a binding contract.

8. If my/ our tender is accepted, I/We am/are to be jointly and severly responsible for the due performance of the Contract. I/We also declare that the firm has not been banned or blacklisted by any Govt. or its department or any Quasi Govt. agency or Public Sector Undertaking or Multilateral or International Aid Agency/Development Bank.

9.I/ We understand that you are not bound to accept the lowest or any Tender you may receive and may reject all or any tender without assigning any reason.

10.I/ We certify that the tender submitted by me, us is strictly in accordance with the terms, conditions, specifications etc. as contained in the tender document, and it is further certified that it does not contain any deviation to the aforesaid documents.

Date

Signature

Name

Designation

duly authorized to sign & submit tender for an on behalf of
(Name and address of firm)

M/s

.....

Telephone nos.....FAX No.....

Witness :

Signature.....

Name :

Occupation

Address

Telephone nos.

FORM 4B: AVERAGE ANNUAL TURNOVER

(To be submitted on the letter head of Chartered Accountant / Statutory Auditor)

Sl. No.	Financial Years	Annual Turnover in INR
1.	
2.	
3.	
4.	Total (1+2+3)	
5.	Average Annual Turnover	<i>[indicate sum of the above figures divided by 3]</i>

Certificate from the Statutory Auditor

This is to certify that*[Name of the Firm][Registered Address]* has received the payments shown above against the respective years.

Name of Authorized Signatory

Designation:

Name of Firm:.....

(Signature of the Statutory Auditor Seal of the Firm)

Note:

In case the Bidder does not have a statutory auditor, it may provide the certificate from a practicing chartered accountant.

FORM 4C: POWER OF ATTORNEY

(To be executed on non-judicial stamp paper of Rs. 100 and duly notarised. The stamp paper to be in the name of the company who is issuing the Power of Attorney)

Know all men by these presents, We,(name of organization and address of the registered office) do hereby constitute, nominate, appoint and authorize Mr./Ms.son / daughter / wife and presently residing atwho is presently employed with / retained by us and holding the position of, as our true and lawful attorney (hereinafter referred to as the "**Authorized Representative**"), with power to sub-delegate to any person, to do in our name and on our behalf, all such acts, deeds and things as are necessary or required in connection with or incidental to submission of our Bid for ".....(insert name of the assignment)". The selection of Contractor for Inland Waterways Authority of India (the "Employer") including but not limited to signing and submission of all applications, Bids and other documents and writings, participating in pre-bid and other conferences and providing information / responses to the Employer, representing us in all matters before the Employer, signing and execution of all contracts and undertakings consequent to acceptance of our Bid and generally dealing with the Employer in all matters in connection with or relating to or arising out of our Bid for the said Project and / or upon award thereof to us till the entering into of the Contract with the Employer.

AND, we do hereby agree to ratify and confirm all acts, deeds and things lawfully done or caused to be done by our said Authorized Representative pursuant to and in exercise of the powers conferred by this Power of Attorney and that all acts, deeds and things done by our said Authorized Representative in exercise of the powers hereby conferred shall and shall always be deemed to have been done by us.

IN WITNESS WHEREOF WE, THE ABOVE NAMED PRINCIPAL HAVE EXECUTED THIS POWER OF ATTORNEY ON THIS DAY OF....., 20**

For ...

(Signature, Name, Designation and Address)

Witnesses:

- 1.....
2.

Accepted

(Signature, name, designation and address of the Attorney)

Notes:

1. The mode of execution of the Power of Attorney should be in accordance with the procedure, if any, laid down by the applicable law and the charter documents of the executant(s) and when it is so required the same should be under common seal affixed in accordance with the required procedure.
2. Wherever required, the Bidder should submit for verification the extract of the charter documents and other documents such as a resolution / power of attorney in favor of the person executing this Power of Attorney for the delegation of power hereunder on behalf of the Applicant
3. For a Power of Attorney executed and issued overseas, the document will also have to be legalized by the Indian Embassy and notarized in the jurisdiction where the Power of Attorney is being issued. However, the Power of Attorney provided by Bidders from countries that have signed the Hague Legislation Convention, 1961 are not required to be legalized by the Indian Embassy if it carries a conforming Apostile certificate.

FORM 4D: DECLARATION BY THE BIDDERS
(To be submitted on the letter head of the Bidder)

To,

Date:.....

Director
Inland Waterways Authority of India
P-78, Garden Reach Road
Kolkata - 700043

Sub: Declaration from the Bidder

Tender Reference No:.....

Dear Sir,

This is with reference to the above mentioned tender document.

We hereby make the following declarations:

1.	<input type="checkbox"/>	No alteration has been made in any form in the Tender document downloaded from the website of IWAI and e-procurement portal.
2.	<input type="checkbox"/>	I / We have not been debarred / blacklisted during the last three years
3.	<input type="checkbox"/>	I / We accept the payment terms of Terms of Reference.
4.	<input type="checkbox"/>	I / We provide our acceptance to all the Terms and Conditions of this tender document.
5.	<input type="checkbox"/>	I / We agree to disqualify us for any wrong declaration with respect to the submissions made by us for this tender and reject my/our tender summarily
6.	<input type="checkbox"/>	I / We agree to disqualify us from this tender and black list us for tendering in IWAI projects in future, if it comes to the notice of IWAI that the documents/submissions made by me/us are not genuine
7.	<input type="checkbox"/>	I / We confirm that I/we have noted / updated ourselves of all amendments / corrigendum / response to pre-submission queries etc. and bid is submitted incorporating the same.

Yours Faithfully

(Signature of the Bidder, with Official Seal)

Note: Please Tick the appropriate box in the above table.

FORM 4E: BIDDER INFORMATION SHEET
(To be submitted on the letter head of the Bidder)

Bidder name:

[insert full name]

Bidder's Party name:

[insert full name]

Bidder's Party country of registration:

[indicate country of registration]

Bidder's year of constitution:

[indicate year of constitution]

Bidder's legal address in country of constitution:

[insert street/ number/ town or city/ country]

Bidder's authorized representative information

Name: *[insert full name]*

Address: *[insert street/ number/ town or city/ country]*

Telephone/Fax numbers: *[insert telephone/fax numbers, including country and city codes]*

E-mail address: *[indicate e-mail address]*

1. Attached are copies of original documents of

- Articles of Incorporation (or equivalent documents of constitution or association), and/or registration documents of the legal entity named above
- In case of a Government-owned enterprise or institution, documents establishing legal and financial autonomy, operation in accordance with commercial law, and absence of dependent status

2. Included are the organizational chart, a list of Board of Directors, and the Beneficial Ownership.

Yours Faithfully

(Signature of the Bidder, with Official Seal)

Note:

This Form shall be uploaded with Identity proof of the authorized representative

*Providing Barbed wire fencing alongwith two nos entry & exit gate
at 120 acres of acquired land of ICLP at Sahibganj during 2022-23*

*Inland Waterways Authority of India,
(Ministry of Ports, Shipping & Waterways, Govt. of India),*

PART - II

To be signed by the bidders' and same signatory competent/ authorized to sign the relevant contract on behalf of IWAI.

INTEGRITY AGREEMENT

This Integrity Agreement is made at on thisday of 20.....

BETWEEN

Chairperson, Inland Waterways Authority of India represented through Director/Chief Engineer, Inland Waterways Authority of India, A - 13, Sec. - 1, Noida.

IWAI, (Hereinafter referred as the 'Principal/ Owner', which expression shall unless repugnant to the meaning or context hereof include its successors and permitted assigns)

AND

.....
(Name and Address of the Individual/firm/Company)

through(Hereinafter referred to as the
(Details of duly authorized signatory)

"Bidder/Contractor" and which expression shall unless repugnant to the meaning or context hereof include its successors and permitted assigns) Preamble

WHEREAS the Principal / Owner has floated the Tender (NIT No.IWAI/KOL/8/SAHIBGANJ/2022-23) (hereinafter referred to as "Tender/Bid") and intends to award, under laid down organizational procedure, contract for "**Providing Barbed wire fencing alongwith two nos entry & exit gate at 120 acres of acquired land of ICLP at Sahibganj during 2022-23.**" hereinafter referred to as the "Contract".

AND WHEREAS the Principal/Owner values full compliance with all relevant laws of the land, rules, regulations, economic use of resources and of fairness/transparency in its relation with its Bidder(s) and Contractor(s).

AND WHEREAS to meet the purpose aforesaid both the parties have agreed to enter into this Integrity Agreement (hereinafter referred to as "Integrity Pact" or "Pact"), the terms and conditions of which shall also be read as integral part and parcel of the Tender/Bid documents and Contract between the parties.

NOW, THEREFORE, in consideration of mutual covenants contained in this Pact, the parties hereby agree as follows and this Pact witnesses as under:

Article 1: Commitment of the Principal/Owner

- 1) The Principal/Owner commits itself to take all measures necessary to prevent corruption and to observe the following principles:
 - (a) No employee of the Principal/Owner, personally or through any of his/her family members, will in connection with the Tender, or the execution of the Contract, demand, take a promise for or accept, for self or third person, any material or immaterial benefit which the person is not legally entitled to.
 - (b) The Principal/Owner will, during the Tender process, treat all Bidder(s) with equity and reason. The Principal/Owner will, in particular, before and during the Tender process, provide to all Bidder(s) the same information and will not provide to any Bidder(s) confidential / additional information through which the Bidder(s) could obtain an advantage in relation to the Tender process or the Contract execution.
 - (c) The Principal/Owner shall Endeavour to exclude from the Tender process any person, whose conduct in the past has been of biased nature.

- 2) If the Principal/Owner obtains information on the conduct of any of its employees which is a criminal offence under the Indian Penal code (IPC)/Prevention of Corruption Act, 1988 (PC Act) or is in violation of the principles herein mentioned or if there be a substantive suspicion in this regard, the Principal/Owner will inform the Chief Vigilance Officer and in addition can also initiate disciplinary actions as per its internal laid down policies and procedures.

Article 2: Commitment of the Bidder(s)/Contractor(s)

1. It is required that each Bidder/Contractor (including their respective officers, employees and agents) adhere to the highest ethical standards, and report to the IWAI all suspected acts of fraud or corruption or Coercion or Collusion of which it has knowledge or becomes aware, during the tendering process and throughout the negotiation or award of a contract.
2. The Bidder(s)/Contractor(s) commit himself to take all measures necessary to prevent corruption. He commits himself to observe the following principles during his participation in the Tender process and during the Contract execution:
 - a) The Bidder(s)/Contractor(s) will not, directly or through any other person or firm, offer, promise or give to any of the Principal/Owner's employees involved in the tender process or execution of the contract or to any third person any material or other benefit which he/she is not legally entitled to, in order to obtain in exchange any advantage of any kind whatsoever during the Tender process or during the execution of the contract.
 - b) The Bidder(s)/Contractor(s) will not enter with other Bidder(s) into any undisclosed agreement or understanding, whether formal or informal. This applies in particular to prices, specifications, certifications, subsidiary contracts, submission or non-submission of bids or any other actions to restrict competitiveness or to cartelize in the bidding process.
 - c) The Bidder(s)/Contractor(s) will not commit any offence under the relevant IPC/PC Act. Further the Bidder(s)/Contractor(s) will not use improperly, (for the purpose of competition or personal gain), or pass on to others, any information or documents provided by the Principal/Owner as part of the business relationship, regarding plans, technical proposals and business details, including information contained or transmitted electronically.
 - d) The Bidder(s)/Contractor(s) of foreign origin shall disclose the names and addresses of agents/representatives in India, if any. Similarly Bidder(s)/Contractor(s) of Indian Nationality shall disclose names and addresses of foreign agents/representatives, if any. Either the Indian agent on behalf of the foreign principal or the foreign principal directly could bid in a tender but not both. Further, in cases where an agent participate in a tender on behalf of one manufacturer, he shall not be allowed to quote on behalf of another manufacturer along with the first manufacturer in a subsequent/parallel tender for the same item.
 - e) The Bidder(s)/Contractor(s) will, when presenting his bid, disclose any and all payments he has made, is committed to or intends to make to agents, brokers or any other intermediaries in connection with the award of the Contract.
3. The Bidder(s)/Contractor(s) will not instigate third persons to commit offences outlined above or be an accessory to such offences.
4. The Bidder(s)/Contractor(s) will not, directly or through any other person or firm indulge in fraudulent practice means a willful misrepresentation or omission of facts

or submission of fake/forged documents in order to induce public official to act in reliance thereof, with the purpose of obtaining unjust advantage by or causing damage to justified interest of others and/or to influence the procurement process to the detriment of the Government interests.

5. The Bidder(s)/Contractor(s) will not, directly or through any other person or firm use Coercive Practices (means the act of obtaining something, compelling an action or influencing a decision through intimidation, threat or the use of force directly or indirectly, where potential or actual injury may befall upon a person, his/ her reputation or property to influence their participation in the tendering process).

Article 3: Consequences of Breach

Without prejudice to any rights that may be available to the Principal/Owner under law or the Contract or its established policies and laid down procedures, the Principal/Owner shall have the following rights in case of breach of this Integrity Pact by the Bidder(s)/Contractor(s) and the bidder/contractor accepts and undertakes to respect and uphold the Principal/Owner's absolute right:

1. If the Bidder(s)/Contractor(s), either before award or during execution of Contract has committed a transgression through a violation of Article 2 above or in any other form, such as to put his reliability or credibility in question, the Principal/Owner after giving 14 days' notice to the contractor shall have powers to disqualify the Bidder(s)/Contractor(s) from the tender process or terminate/determine the Contract, if already executed or exclude the Bidder/Contractor from future contract award processes. The imposition and duration of the exclusion will be determined by the severity of transgression and determined by the Principal/Owner. Such exclusion may be forever or for a limited period as decided by the Principal/Owner.
2. Forfeiture of EMD/Performance Guarantee/Security Deposit: If the Principal/Owner has disqualified the Bidder(s) from the tender process prior to the award of the contract or terminated/determined the contract or has accrued the right to terminate/determine the contract according to Article 3(1), the Principal/Owner apart from exercising any legal rights that may have accrued to the Principal/Owner, may in its considered opinion forfeit the entire amount of Earnest Money Deposit, Performance Guarantee and Security Deposit of the Bidder/Contractor.
3. Criminal Liability: If the Principal/Owner obtains knowledge of conduct of a bidder or Contractor, or of an employee or a representative or an associate of a bidder or Contractor which constitutes corruption within the meaning of IPC Act, or if the Principal/Owner has substantive suspicion in this regard, the Principal/Owner will inform the same to law enforcing agencies for further investigation.

Article 4: Previous Transgression

- 1) The Bidder declares that no previous transgressions occurred in the last 5 years with any other Company in any country confirming to the anticorruption approach or with Central Government or State Government or any other Central/State Public Sector Enterprises in India that could justify his exclusion from the Tender process.
- 2) If the Bidder makes incorrect statement on this subject, he can be disqualified from the Tender process or action can be taken for banning of business dealings/ holiday listing of the Bidder/Contractor as deemed fit by the Principal/ Owner.
- 3) If the Bidder/Contractor can prove that he has resorted / recouped the damage caused by him and has installed a suitable corruption prevention system, the Principal/Owner may, at its own discretion, revoke the exclusion prematurely.

Article 5: Equal Treatment of all Bidders/Contractors/Subcontractors

- 1) The Bidder(s)/Contractor(s) undertake(s) to demand from all subcontractors a commitment in conformity with this Integrity Pact. The Bidder/Contractor shall be responsible for any violation(s) of the principles laid down in this agreement/Pact by any of its Subcontractors/ sub-vendors.
- 2) The Principal/Owner will enter into Pacts on identical terms as this one with all Bidders and Contractors.
- 3) The Principal/Owner will disqualify Bidders, who do not submit, the duly signed Pact between the Principal/Owner and the bidder, along with the Tender or violate its provisions at any stage of the Tender process, from the Tender process.

Article 6: Duration of the Pact

This Pact begins when both the parties have legally signed it. It expires for the Contractor/Vendor 12 months after the completion of work under the contract or till the continuation of defect liability period, whichever is more and for all other bidders, till the Contract has been awarded.

If any claim is made/lodged during the time, the same shall be binding and continue to be valid despite the lapse of this Pacts as specified above, unless it is discharged/determined by the Competent Authority, IWAI.

Article 7: Other Provisions

- 1) This Pact is subject to Indian Law, place of performance and jurisdiction is the Headquarters of the Division of the Principal/Owner, who has floated the Tender.
- 2) Changes and supplements need to be made in writing. Side agreements have not been made.
- 3) If the Contractor is a partnership or a consortium, this Pact must be signed by all the partners or by one or more partner holding power of attorney signed by all partners and consortium members. In case of a Company, the Pact must be signed by a representative duly authorized by board resolution.
- 4) Should one or several provisions of this Pact turn out to be invalid; the remainder of this Pact remains valid. In this case, the parties will strive to come to an agreement to their original intentions.
- 5) It is agreed term and condition that any dispute or difference arising between the parties with regard to the terms of this Integrity Agreement / Pact, any action taken by the Owner/Principal in accordance with this Integrity Agreement/ Pact or interpretation thereof shall not be subject to arbitration.

Article 8: LEGAL AND PRIOR RIGHTS

All rights and remedies of the parties hereto shall be in addition to all the other legal rights and remedies belonging to such parties under the Contract and/or law and the same shall be deemed to be cumulative and not alternative to such legal rights and remedies aforesaid. For the sake of brevity, both the Parties agree that this Integrity Pact will have precedence over the Tender/Contact documents with regard any of the provisions covered under this Integrity Pact.

IN WITNESS WHEREOF the parties have signed and executed this Integrity Pact at the place and date first above mentioned in the presence of following witnesses:

.....
(For and on behalf of Principal/Owner)

.....
(For and on behalf of Bidder/Contractor)

WITNESSES:

1.
(signature, name and address)

2.
(signature, name and address)

Place:

Date:

SCHEDULES

SCHEDULE 'A' : Salient Features of the work.

Name of Work :Providing Barbed wire fencing alongwith two nos entry & exit gate at 120 acres of acquired land of ICLP at Sahibganj during 2022-23.

Estimated cost of work: The work is estimated to cost Rs.51,22,107/-
This estimate, however, is given merely as a rough guide.

(a) Earnest Money :Rs.1,02,442/-

(b) Performance Guarantee : 5% of tendered value.

(c) Security Deposit :5% of tendered value (A sum @ 10% of the gross amount of the bill shall be deducted from each running bill till the sum along with the EMD is equivalent to 5% of contract value)

SCHEDULE 'B' :

General Rules & Directions with reference to General Conditions of Contract: -

(i). **Officer inviting tender: - Director**

(ii). **Tender Accepting Authority:- Inland Waterways Authority of India**

(iii). **(a) Time allowed for submission of Performance Guarantee as per clause 3.1 of GCC from the date of issue of letter of acceptance:-** 15 days

(b) Maximum allowable extension beyond the period provided in (iii) (a) above:-
7 days

(iv) **Percentage on Cost of Materials & Labour to cover all overheads and profits:-** 15%

(v) **Standard Schedule of Rates:-** Reference of Market Rates

(vi) **Specifications to be followed:-** -----

(vii) **Deviation Limit beyond which clause 16.3, 16.4, 16.5 & 16.6:-** 25%

(viii) **Competent authority of grant extension of time under clause 34: -**

(a) Regional Director/EIC (Field), IWAI (if the amount of contract is upto 100 lakhs).

(b) Chief Engineer (if the amount of contract is more than 100 lakh upto 200 lakhs).

(c) Member (Technical), IWAI (if the amount of contract is more than 200 lakh upto 300 lakhs).

(d) Vice-Chairman IWAI, Noida (if the cost of contract is more than 300 lakhs & up to 1000 lakhs).

(e) Chairman, IWAI, Noida (Full power).

(ix) **Competent authority to levy liquidated damages for delay under clause 35:-**

(a) Regional Director (Field)/Engineering In Charge of the project (Full power)

(x) Competent authority to determine the contract as per clause 36:-

- (a) Regional Director (Field), IWAI (if the amount of contract is upto 100 lakhs).
- (b) Member (Technical), IWAI (if the amount of contract is more than 100 lakh upto 300 lakhs).
- (c) Vice-Chairman / Chairperson, IWAI, Noida (if the cost of contract is more than 300 lakhs & up to 1000 lakhs).
- (d) Chairman, IWAI, Noida (if the amount of contract is more than 1000 lakhs).

(xi) Milestones as per table given below:

(Clause 34.5 & 34.6 shall be applicable only when the amount of the contract is more than 10 crores)

Sl. No.	Milestone	Time Allowed (from date of start) in months	Amount to be withheld in case of non-achievement of mile stone
1.			
2.			
3.			
4.			
5.			

(xii) Competent authority to reschedule the milestones as per clause 34.5:-

Chairman, IWAI, Noida

(xiii) Competent authority for foreclosure of contract in full or in part due to abandonment or reduction in scope of work as per clause 31:-

- (a) Engineer-in-Charge with the prior approval of
- (b) Member Technical), IWAI (if the amount of contract is up to 300 lakhs).
- (c) Vice-Chairman/ Chairperson, IWAI, Noida (if the cost of contract is more than 300 lakhs & up to 1000 lakhs).
- (d) Chairman, IWAI, Noida (if the amount of contract is more than 1000 lakhs).

(xiv) Incentive for early completion.

(a) Whether Clause 50 is applicable:-

Not Applicable

.....

GENERAL CONDITIONS OF CONTRACT

- CLAUSE-1 : DEFINITIONS
- CLAUSE-2 : INTERPRETATIONS
- CLAUSE-3 : PERFORMANCE GUARANTEE
- CLAUSE-4 : SECURITY DEPOSIT
- CLAUSE-5 : SUFFICIENCY OF TENDER
- CLAUSE-6 : CONTRACT DOCUMENTS
- CLAUSE-7 : DISCREPANCIES AND ADJUSTMENT OF ERRORS
- CLAUSE-8 : DUTIES AND POWERS OF ENGINEER-IN-CHARGE'S REPRESENTATIVE
- CLAUSE-9 : ASSIGNMENT AND SUB-LETTING
- CLAUSE-10 : FACILITIES TO OTHER CONTRACTORS
- CLAUSE-11 : CHANGE IN CONSTITUTION OF THE FIRM TO BE INTIMATED
- CLAUSE-12 : COMMENCEMENT OF WORK
- CLAUSE-13 : WORKS TO BE CARRIED OUT IN ACCORDANCE WITH SPECIFICATIONS DRAWINGS AND ORDERS ETC.
- CLAUSE-14 : SETTING OUT THE WORKS
- CLAUSE-15 : URGENT WORKS
- CLAUSE-16 : DEVIATIONS, VARIATIONS, EXTENT & PRICING
- CLAUSE-17 : CONTRACTOR'S SUPERVISION
- CLAUSE-18 : INSTRUCTIONS AND NOTICE
- CLAUSE-19 : PLANT AND EQUIPMENT
- CLAUSE-20 : PATENT RIGHTS
- CLAUSE-21 : MATERIALS
- CLAUSE-22 : LAWS GOVERNING THE CONTRACT
- CLAUSE-23 : WATCH & WARD AND LIGHTING
- CLAUSE-24 : WORK DURING NIGHT OR ON SUNDAYS AND HOLIDAYS
- CLAUSE-25 : LABOUR
- CLAUSE-26 : MATERIALS OBTAINED FROM EXCAVATION SUCH AS FOSSILS, COINS ETC.
- CLAUSE-27 : FORCE MAJEURE
- CLAUSE-28 : LIABILITY FOR DAMAGE, DEFECTS OR IMPERFECTIONS AND RECTIFICATION THEREOF
- CLAUSE-29 : CONTRACTOR'S LIABILITY AND INSURANCE
- CLAUSE-30 : SUSPENSION OF WORKS
- CLAUSE-31 : FORE CLOSURE OF CONTRACT IN FULL OR IN PART DUE TO ABANDONMENT OR REDUCTION IN SCOPE OF WORK
- CLAUSE-32 : TERMINATION OF CONTRACT ON DEATH
- CLAUSE-33 : CARRYING OUT PART WORK AT THE RISK & COST OF THE CONTRACTOR
- CLAUSE-34 : COMPLETION TIME AND EXTENSIONS
- CLAUSE-35 : LIQUIDATED DAMAGES FOR DELAY
- CLAUSE-36 : WHEN THE CONTRACT CAN BE DETERMINED
- CLAUSE-37 : INSPECTION AND APPROVAL
- CLAUSE-38 : COMPLETION CERTIFICATE & COMPLETION PLANS
- CLAUSE-39 : MEASUREMENTS
- CLAUSE-40 : PAYMENT ON ACCOUNT
- CLAUSE-41 : TAXES, DUTIES AND LEVIES ETC
- CLAUSE-42 : TAX DEDUCTION AT SOURCE
- CLAUSE-43 : PAYMENT OF FINAL BILL
- CLAUSE-44 : OVER PAYMENTS AND UNDER PAYMENTS
- CLAUSE-45 : FINALITY CLAUSE
- CLAUSE-46 : SUM PAYABLE BY WAY OF COMPENSATION TO BE CONSIDERED IS REASONABLE WITHOUT PREFERENCE TO ACTUAL LOSS
- CLAUSE-47 : SETTLEMENT OF DISPUTES & ARBITRATION
- CLAUSE-48 : CLAIM

GENERAL CONDITIONS OF CONTRACT

CLAUSE - 1: DEFINITIONS

In the contract, the following words & expressions shall, unless context otherwise requires, have the meaning thereby respectively assigned to them:

- i) **Contract:** means the documents forming the tender and acceptance thereof and the formal agreement executed between the competent authority on behalf of the Chairman, Inland Waterways Authority of India and the contractor, together within the documents referred to therein including these conditions, the specifications, designs, drawings and instructions issued from time to time by the Engineer-in-charge and all these documents taken together shall be deemed to form one contract and shall be complementary to one another
- ii) **Contract sum;** means the amount arrived at by multiplying the quantities shown in the schedule of quantities and price by the respective item rates as allowed.
- iii) **Contractor:** means the successful tenderer who is awarded the contract to perform the work covered under this tender documents and shall be deemed to include the contractor's successors, executors, representatives or assign approved by the Engineer-in-charge.
- (iv) **Employer** means the Chairman, Inland Waterways Authority of India and his successors.
- (v) **IWAI/ Authority/ Department/ Owner** shall mean the Inland Waterways Authority of India, which invites tenders on behalf of the Chairman, IWAI and includes therein-legal representatives, successors and assigns.
- (vi) **Engineer-In-Charge (EIC)** means the Engineer officer authorised to direct, supervise and be In-charge of the works for the purpose of this contract who shall supervise and be in charge of the work.
- (vii) **Engineer-in-charge representative** shall mean any officer of the Authority nominated by the Engineer-in-charge for day to day supervision, checking, taking measurement, checking bills, ensuring quality control, inspecting works and other related works for completion of the project.
- (viii) **Chairman:** means Chairman of Inland Waterways Authority of India.
- (ix) **Chief Engineer:** means the Chief Engineer of the Authority.
- (x) **Director** means the Director of the Authority, as the case may be.
- (xi) **Deputy Director** means the Deputy Director of the Authority, as the case may be.
- (xii) **Assistant Director** means the Asstt. Director of the Authority, as the case may be.
- (xiii) **Assistant Hydrographic Surveyor** means the Assistant Hydrographic Surveyor of the Authority, as the case may be
- (xiv) **Work Order** means a letter from the Authority conveying the acceptance of the tender/offer subject to such reservations as may have been stated therein.
- (xv) **Day :** means a calendar day beginning and ending at mid-night.
- (xvi) **Week :** means seven consecutive calendar days

- (xvii) **Month** : means the one Calendar month.
- (xviii) **Site** means the waterway and / or other places through which the works are to be executed.
- (xix) **Vessel** : means the vessel/craft belonging to the Contractor for carrying out the work.
- (xx) **High Mast Light** : A tall pole with lighting attached to the top pointing towards The ground , usually but not always used to light a Highway or recreational field.
- (xxi) **Luminaries**: An object , such as a celestial body , that gives light.
- (xxii) **Mast Feeder Pillar**: Provides local isolation to electrical distribution equipment , protecting both cabling and the transformer from faults.
- (xxiii) **Drawings** : means the drawings referred to in the specifications and / or appended with the tender document, any modifications of such drawings approved in writing by the Engineer-in-Charge and shall also include drawings issued for actual execution of the work time to time by the Engineer-in-Charge.
- (xxiv) **Urgent Works**: means any urgent nature which in the opinion of the Engineer-In-Charge become necessary at the time of execution and / or during the progress of work to obviate any risk or accident or failure or to obviate any risk of damage to the vessel structure, or required to accelerate the progress of work or which becomes necessary for security or for any other reason the Engineer-in-Charge may deem expedient.
- (xxv) **Work/ works**: means work / works to be executed in accordance with the contract.
- (xxvi) Schedules referred to in these conditions shall mean the relevant schedules annexed to the tender papers or the standard schedule of rates of the govt. mentioned with the amendments thereto issued up to the date of receipt of the tender.
- (xxvii) District specifications means the specifications followed by the State Government in the area where the work is to be executed.
- xxviii) Tendered value means the value of the entire work as stipulated in the letter of award.

CLAUSE – 2: INTERPRETATIONS

- 2.1 Where the contract so requires, words imparting the singular only shall also include the plural and vice versa. Any reference to masculine gender shall whenever required include feminine gender and vice versa.
- 2.2 Heading and marginal notes in these General Conditions shall not be deemed to form part thereof or be taken into consideration in the interpretation of construction thereof of the contract.

CLAUSE – 3: PERFORMANCE GUARANTEE

- 3.1 The contractor shall be required to deposit an amount equal to 5% of the tendered value of the work as performance guarantee in the form of either demand draft payable at any nationalized/schedule bank **OR** an irrevocable bank guarantee bond of any scheduled bank or State Bank of India in accordance with the form prescribed within 15 days of the issue of the work order.
- 3.2 Performance guarantee shall be initially valid up to the stipulated date of completion plus sixty days beyond that. In case the time for completion gets enlarged, the contractor shall get the validity of the performance guarantee extended to cover such

enlarged time of the work. After recording of the completion certificate for the work by the competent authority, the performance guarantee shall be returned to the contractor without any interest.

- 3.3 In the event of contract being determined under the provision of any of the clauses/conditions of agreement, the performance guarantee shall be forfeited in full and shall be absolutely at the disposal of the authority.

CLAUSE – 4: SECURITY DEPOSIT

- 4.1 A sum @ 10% of the gross amount of the bill shall be deducted from each running bill of the contractor till the sum along with the sum already deposited as the earnest money will amount to security deposit of 5% of the contract value of work. **Bank guarantee will not be accepted as security deposit.**

In case of MSME registered firms, deduction of a sum of 10% of the gross amount of the bill from each running bill till that amount reaches 5% of the contract value of the work as Security Deposit will also be made.

- 4.2 The total security deposit shall remain with IWAI till the defect liability period is over or the payment of the final bill payable in accordance with agreement conditions whichever is later, provided the Engineer-in-Charge is satisfied that there is no demand outstanding against the contractor.
- 4.3 No interest will be paid on security deposit.
- 4.4 If the contractor neglects to observe or fails to perform any of his obligations under the contract, it shall be lawful for the Employer/ EIC to forfeit either in whole or in part, the security deposit furnished by the contractor. However, if the contractor duly performs and completes the contract in all respects and presents in absolute "NO DEMAND CERTIFICATE" in the prescribed form, the IWAI shall refund the security deposit to the contractor after deduction of cost and expenses that the Authority may have incurred and other money including all losses and damages which the Authority is entitled to recover from the Contractor.
- 4.5 In case of delay in the progress of work, the Engineer- in-Charge shall issue to the contractor a memo in writing pointing out the delay in progress and calling upon the contractor to explain the causes for the delay within 3 days of receipt of the memo and 10 days from issuance of memo whichever is earlier. If the Engineer-in-Charge is not satisfied with the explanations offered, he may forfeit the security deposit and / or withhold payment of pending bills in whole or in part and/ or get the measures of rectification of progress of work accelerated to the pre-defined level at the risk and cost of the contractor.
- 4.6 All compensation or other sums of money payable by the contractor under the terms of the contract or any other contract or on any other account whatsoever, may be deducted from or paid by the sale of a sufficient part of his security or from the interest arising there from or from any sums which may be due or may become due to the contractor by the Authority on any account whatsoever. Also in the event of the contractor's security deposit being reduced by reasons of such deductions or sale, as aforesaid the contractor shall, within 14 days of receipt of notice of demand from the Engineer-in-Charge make good the deficit in his security deposit.

CLAUSE – 5: SUFFICIENCY OF TENDER

The contractor shall be deemed to have satisfied himself before tendering as to the correctness and sufficiency of his tender for the works and of the rates quoted in the schedule of Quantities and Prices which shall (except as otherwise provided in the contract) cover all his obligations under the contract and all matters and things necessary for the proper execution and completion of the works in accordance with the provisions of the contract and its operation during execution of work.

CLAUSE – 6: CONTRACT DOCUMENTS

- 6.1 The language in which the contract documents shall be drawn up shall be English and if the said documents are written in more than one languages, the language according to which the contract is to be constructed and interpreted shall be English.
- 6.2 The Contractor shall be furnished free of charge certified true copy of the contract document.
- 6.3 A copy of the Contract Documents furnished to the Contractor as aforesaid shall be kept by the Contractor on the Site in good condition and the same shall at all reasonable time be available for inspection and use by the Engineer-in-Charge, his representatives or by other Inspecting officers of the Authority.
- 6.4 None of these Documents shall be used by the Contractor for any purpose other than that of this contract.

CLAUSE – 7: DISCREPANCIES AND ADJUSTMENT OF ERRORS

- 7.1 Detailed drawings shall be followed in preference to small-scale drawings and figured dimensions in preference to scaled dimensions. The case of discrepancy between the Schedule of Quantities and prices, the Specifications and/ or the drawings, the following order of precedence shall be observed : -
- (a) Description in the Schedule of Quantities and Prices.
 - (b) Relevant Specifications and Special Conditions, if any.
 - (c) Drawings.
 - (d) Indian Standards Specifications of BIS.
- 7.2 The contractor shall study and compare the drawings, specifications and other relevant information given to him by the Engineer-in-Charge and shall report in writing to the Engineer-in-Charge any discrepancy and inconsistency which he notes. The decision of the Engineer-in-Charge regarding the correct intent and meaning of the drawings and specifications shall be final and binding.
- 7.3 Any error in description, quantity or price in Schedule of Quantities and Prices or any omission therefrom shall not vitiate the Contract or release the Contractor from the execution of the whole or any part of the work(s) comprised therein according to drawings and specifications or from any of his obligations under the contract.
- 7.4 If on check there is difference in the amount worked out by contractor in the schedule of quantities and prices and General summary the same shall be adjusted in accordance with the following rules:
- (a) In the event of error/discrepancy occurring in the rates written in figures and words, then the rate which corresponds with the amount worked out by the contractor shall, unless otherwise proved, be taken as correct. If the amount of an item is not worked out by the contractor or it does not correspond with the rate written either in figures or in words, then the rate quoted by the contractor in words shall be taken as correct. When the rate quoted by the contractor in figures and words tally, but the amount is not worked out correctly, the rate quoted by the contractor will, unless or otherwise proved, be taken as correct.
 - (b) All errors in totalling in the amount column and in carrying forward totals shall be corrected.
 - (c) The totals of various sections of schedule of quantities and price amended shall be carried over to the General Summary and the tendered sum amended accordingly. The tendered sum so altered shall, for the purpose of tender, be substituted for the sum originally tendered and considered for acceptance instead of the original sum quoted by the tenderer. Any rounding off of quantities or in sections of schedule of quantities and prices or in General summary by the tenderer shall be ignored.

CLAUSE-8: DUTIES AND POWERS OF THE ENGINEER-IN-CHARGE REPRESENTATIVE

- 8.1 The duties of the representative of the Engineer-in-Charge are to watch and supervise the works and to test and examine any materials/ parts to be used or workmanship achieved in connection with the works.
- 8.2 The Engineer-in-Charge may, from time to time in writing, delegate to his representative any of the powers and authorities, vested in the Engineer-in- Charge and shall furnish to the contractor a copy of all such written delegation of powers and authorities. Any written instruction or written approval given by the representative of the Engineer-in-Charge to the contractor within the terms of such delegation shall bind the contractor and the Authority as though it has been given by the Engineer-in-Charge.
- 8.3 Failure of the representative of the Engineer-in-Charge to disapprove any work or materials shall be without prejudice to the power of the Engineer-in-Charge thereafter to disapprove such work or materials and to order the pulling down, removal or breaking up thereof. The contractor shall, at his own expense, again carry out such works as directed by the Engineer-in-Charge.
- 8.4 If the Contractor is dissatisfied with any decision of the representative of the Engineer-in-Charge, he will be entitled to refer the matter to the Engineer-in- Charge who shall thereupon confirm, reverse or vary such decision and the decision of the Engineer-in-Charge in this regard shall be final and binding on the contractor.

CLAUSE – 9: ASSIGNMENT AND SUB-LETTING

The Contractor shall not sub-let, transfer or assign the whole or any part of the work under the contract. Provided that the Engineer-in-Charge may at his discretion, approve and authorize the Contractor to sub-let any part of the work, which in his opinion, is not substantial, after the contractor submits to him in writing the details of the part of the work(s) or trade proposed to be sublet, the name of the sub-contractor thereof together with his past experience in the said work/trade and the form of the proposed sub-contract. Nevertheless any such approval or authorization by the Engineer-in-Charge shall not relieve the contractor from his any or all liabilities, obligations, duties and responsibilities under the contract. The contractor shall also be fully responsible to the Authority for all the acts and omissions of the sub-contractor, his employees and agents or persons directly employed by the contractor. However, the employment of piece rate works shall not be construed as sub-letting.

CLAUSE – 10: FACILITIES TO OTHER CONTRACTORS

The contractors shall, in accordance with the requirements of the work as decided by the Engineer-in- Charge, afford all reasonable facilities to other contractors engaged contemporaneously on separate contracts and for departmental labour and labour of any other agency properly authorised by Authority or any statutory body which may be employed at the site for execution of any work not included in the contract which the Authority may enter into in connection with or ancillary to the works. In all matters of conflict of interest, the Engineer-in-Charge shall direct what compromise should be made and his decision shall be final and binding on the parties.

CLAUSE – 11: CHANGE IN THE CONSTITUTION OF THE FIRM TO BE INTIMATED

Where the contractor is a partnership firm, prior approval in writing of the Engineer-in-Charge shall be obtained before any change is made in the constitution of the firm. Where the contractor is an individual or a Hindu Undivided Family business concern, such approval, as aforesaid, shall like-wise be obtained before the contractor enters into any partnership agreement where under the partnership firm would have the right to carry out the works hereby undertaken by the contractor. If prior approval as aforesaid is not obtained the contractor shall be deemed to have been assigned in contravention to Clause 36 hereof and the same action will be taken and the same consequences shall ensure as provided for in the said clause-36.

CLAUSE – 12: COMMENCEMENT OF WORK

The contractor shall commence the work at the respective sites within 10 days of the issue of Letter of Award. If the contractor commits default in mobilization of resources, and equipment as aforesaid, the Engineer-in-Charge shall without prejudice to any other right or remedy be at liberty to cancel the contract and forfeit the earnest money/security deposit.

CLAUSE – 13: WORKS TO BE CARRIED OUT IN ACCORDANCE WITH SPECIFICATION DRAWINGS AND ORDERS ETC.

13.1 The contractor shall execute the whole and every part of the work in the most substantial and workman like manner in strict conformity with the specifications laid down in the contract document or as may be laid down by the Engineer-in-Charge under the terms of the contract. The contractor shall also conform exactly, fully and faithfully to the designs, drawings specifications and instructions in writing in respect of the work, duly signed by the Engineer-in-Charge as may be issued from time to time.

13.2 The contractor shall be entitled to receive, on demand, in addition to the contract documents, in accordance with the provisions of contract, the documents set forth herein in respect of the work on commencement or during the performance of the contract:

- (a) Specifications or revisions thereof other than standard printed specifications
- (b) Explanations, instructions etc.

Such further drawings, explanation, modifications and instruction, as the Engineer-in-Charge may issue to the contractor from time to time in respect of the work shall be deemed to form integral part of the contract and the contractor shall be bound to carry out the work accordingly.

13.3 In the case of any class of work for which there is no specifications, such work shall be carried out in accordance with the Bureau of Indian Standards specifications. In case there are no such specifications in the BIS, work shall be carried out as per manufacturer's specifications, if manufacturer's specifications are also not available then as per District specifications. In case there are no such specifications as required, above the work shall be carried out in all respect in accordance with the instructions and requirements of the Engineer-in-Charge.

13.4 All instructions and orders in respect of the work shall be given by the Engineer-in-Charge in writing. However, any verbal instructions or order shall be confirmed by the Engineer-in-Charge as soon as practicable without loss of time and only such written instruction shall be deemed to be valid.

CLAUSE – 14: SETTING OUT THE WORKS

The contractor shall provide all assistance and adhere to the instruction of E.I.C during the course of surveying, inspection, etc.

CLAUSE – 15: URGENT WORKS

If any urgent work (in respect of which the decision of the Engineer-in-Charge shall be final and binding) becomes necessary, the contractor shall execute the same as may be directed by Engineer-in-Charge, provided the directions are in accordance and confirmatory with provisions in Clause – 8.

CLAUSE – 16: DEVIATIONS, VARIATIONS, EXTENT AND PRICING

16.1 The Engineer-in-Charge shall have power (i) to make alteration in, omissions from, additions to, or substitutions for the original specifications, drawings, designs and instructions that may appear to him to be necessary or advisable during the progress of the work, and (ii) to omit a part of the works in case of non-availability of a portion of the site or for any other reasons and the contractor shall be bound to carry out the works in accordance with any instructions given to him in writing signed by the Engineer-in-Charge and such alterations, omissions, additions or substitutions shall form part of the contract as if originally provided therein and any

altered, additional or substituted work which the contractor may be directed to do in the manner specified above as part of the works, shall be carried out by the contractor on the same conditions in all respects including price on which he agreed to do the main work except as hereafter provided.

- 16.2 The time for completion of the works shall, in the event of any deviations resulting in additional cost over the tendered value sum being ordered, be extended, if requested by the contractor, as follows:
- (i) In the proportion which the additional cost of the altered, additional or substituted work, bears to the original tendered value plus
 - (ii) 25% of the time calculated in (i) above or such further additional time as may be considered reasonable by the Engineer-in-Charge.
- 16.3 In the case of extra item(s) (items that are completely new, and are in addition to the items contained in the contract), the contractor may within fifteen days of receipt of order or occurrence of the item(s) claim rates, supported by proper analysis, for the work and the Engineer-in-Charge shall within one month of the receipt of the claims supported by analysis, after giving consideration to the analysis of the rates submitted by the contractor, determine the rates on the basis of the market rates and the contractor shall be paid in accordance with the rates so determined.
- 16.4 In the case of substituted items (items that are taken up with partial substitution or in lieu of items of work in the contract), the rate for the agreement item (to be substituted) and substituted item shall also be determined in the manner as mentioned in the following para.
- (a) If the market rate for the substituted item so determined is more than the market rate of the agreement item (to be substituted), the rate payable to the contractor for the substituted item shall be the rate for the agreement item (to be substituted) so increased to the extent of the difference between the market rates of substituted item and the agreement item (to be substituted).
 - (b) If the market rate for the substituted item so determined is less than the market rate of the agreement item (to be substituted), the rate payable to the contractor for the substituted item shall be the rate for the agreement item (to be substituted) so decreased to the extent of the difference between the market rates of substituted item and the agreement item (to be substituted).
- 16.5 In the case of contract items, substituted items, contract cum substituted items, which exceed the deviation limits laid down in Schedule 'B', the contractor may within fifteen days of receipt of order or occurrence of the excess, claim revision of the rates, supported by proper analysis for the work in excess of the above mentioned limits, provided that if the rates so claimed are in excess of the rates specified in the schedule of quantities, the Engineer-in-Charge shall within one month of receipt of the claims supported by analysis, after giving consideration to the analysis of the rates submitted by the contractor, determine the rates on the basis of the market rates and the contractor shall be paid in accordance with the rates so determined.
- 16.6 The provisions of the paragraph 16.4 above shall also apply to the decrease in the rates of items for the work in excess of the limits laid down in Schedule 'B', and the Engineer-in-Charge shall after giving notice to the contractor within one month of occurrence of the excess and after taking into consideration any reply received from him within fifteen days of the receipt of the notice, revise the rates for the work in question within one month of the expiry of the said period of fifteen days having regard to the market rates.
- 16.7 Under the circumstances, the contractor shall at any stage not suspend the work on account of non-settlement of rates of such Deviated/Extra/Substituted items.

CLAUSE - 17: CONTRACTOR'S SUPERVISION

- 17.1 The contractor shall either himself supervise the execution of the works or shall appoint at his own expense, a qualified and experienced Engineer as his accredited agent approved by the Engineer-in-Charge, if contractor has himself not sufficient knowledge or experience to be capable of receiving instruction or cannot give his full attention to the works. The contractor or his agent shall be present at the site(s) and shall supervise the execution of the works with such additional assistance in each trade, as the work involved shall require and considered essential by the Engineer-in-Charge. Further the directions/instructions given by the Engineer-in-Charge to the contractor's agent shall be considered to have the same force as if these had been given to the contractor himself.
- 17.2 If the contractor fails to appoint a suitable agent as directed by the Engineer-in-Charge, the Engineer-in-Charge shall have full powers to suspend the execution of the works until such date as a suitable agent is appointed by the contractor and takes over the charge of supervision of the work. For any such suspension, the contractor shall be held responsible for delay so caused to the work.

CLAUSE - 18: INSTRUCTIONS AND NOTICE

- 18.1 Except as otherwise provided in this contract, all notices to be given on behalf of the Authority and all other actions to be taken on its behalf may be given or taken by the Engineer-in-Charge or any officer for the time being entrusted with the functions, duties and powers of the Engineer-in-Charge.
- 18.2 All instructions, notices and communications etc. under the contract shall be given in writing and any such oral orders / instructions given shall be confirmed in writing and no such communication which is not given or confirmed in writing shall be valid.
- 18.3 All instructions, notices and communications shall be deemed to have been duly given or sent to the contractor, if delivered to the contractor, his authorized agent, or left at, or posted to the address given by the contractor or his authorized agent or to the last known place of abode or business of the contractor or his agent of services by post shall be deemed to have been served on the date when in the ordinary course of post these would have been delivered to him and in other cases on the day on which the same were so delivered or left.
- 18.4 The Engineer-in-Charge shall communicate or confirm the instructions to the contractor in respect of the execution of work through a "Site Order Book" maintained in the office of the Engineer-in-Charge and the contractor or his authorized representative shall confirm receipt of such instructions by signing the relevant entries in this book. If required by the Contractor, he shall be furnished a certified true copy of such instruction(s). The pro-forma for Site Order Book to be maintained at site is given in Annexure – III.
- 18.5 The "Hindrance Register" shall be maintained at the site of work, where any hindrance which comes to the notice of the representative of the Engineer-in-Charge shall be recorded and immediately a report will be made to the Engineer-in-Charge within a week. The Engineer-in-Charge shall review the Hindrance Register at least once in a month. The pro-forma on which the Hindrance Register shall be maintained is given in Annexure-IV.

CLAUSE -19: PLANT AND EQUIPMENT

- 19.1 The Contractors shall provide and install all necessary plant; equipment and machinery required for the execution of the work under the contract, at his cost and shall use such methods and appliances for the purpose of all the operations connected with the work

covered by the contract, which shall ensure the completion of work(s) within the specified time.

- 19.2 Subject to the availability of any item(s), plant, equipment and machinery the Authority at the written request of the contractor, may issue to the contractor on hire for being deployed on the work contracted for, at pre- determined rates, terms and conditions at the sole discretion of the Engineer-in-Charge.

CLAUSE – 20: PATENT RIGHTS

The contractor shall indemnify the Authority, its representatives or its employees against any action, claim or proceeding relating to infringement or use of any patent or design or any alleged patent or design rights and shall pay any royalties or other charges which may be payable in respect of any article or material or part thereof included in the contract. In the event of any claim being made or action being brought against the Authority or any agent, servant or employee of the Authority in respect of any such materials as aforesaid the contractor shall immediately be notified thereof. Provided that such indemnification shall not apply when such infringement has taken place in complying with the specific directions issued by the Authority but the contractor shall pay any royalties or other charges payable in respect of any such use, the amount so paid being reimbursement to the contractor only if the use was the result of any drawings and or specifications issued after submission of the tender.

CLAUSE – 21: MATERIALS

- 21.1 The contractor shall at his own expenses provide / arrange all materials required for the bona-fide use on work under the contract.
- 21.2 All materials/parts to be provided by the contractor shall be in conformity with the specifications laid down in the contract and the contractor shall furnish from time to time proof and samples, at his own cost, the materials/parts as may be specified by the Engineer-in-Charge. Further the Engineer-in-Charge shall also have powers to have such tests, in addition to those specified in the contract, as may be required and the contractor shall provide all facilities to carry out the same. The cost of materials/parts consumed in such tests and also the expenses incurred thereon including the cost of the testing charges, shall be borne by the contractor in all cases and also where such tests which are in addition to those provided in the contract disclose that the materials are in conformity with the provisions of the contract.
- 21.3 The Engineer-in-Charge or his representative shall be entitled at any time to inspect and examine any materials/parts intended to be used in the works, either on the site or at factory or workshop or other place(s) where such materials are assembled, fabricated, manufactured or any place where these are lying or from where these are being obtained. For this, purpose, the contractor shall afford such facilities as may be required for such inspection and examination.

CLAUSE - 22: LAWS GOVERNING THE CONTRACT

The Courts at Kolkata only shall have the jurisdiction for filing the award of the arbitration and for any other judicial proceedings.

CLAUSE - 23: WATCH & WARD AND LIGHTING

The Contractor shall provide and maintain at his expense all lights, guards, fencing and watch & ward when and where necessary or as required by the Engineer-in-Charge for the protection of the works or for the safety and convenience of those employed on the works or the public.

CLAUSE - 24: WORK DURING NIGHT OR ON SUNDAYS AND HOLIDAYS

- 24.1 Subject to any provisions to the contrary contained in the contract, none of the works shall be carried out during Sundays and national holidays without the permission in writing of the Engineer-in-Charge. However, when work is unavoidable or necessary for

safety of life, property or works, contractor shall take necessary action immediately and advise the Engineer-in-Charge accordingly.

- 24.2 The Engineer-in-Charge at its discretion may, however, direct the contractor that the work may be carried out on holidays, Sundays and/or in extra shifts to ensure completion of works under the contract as scheduled.

CLAUSE - 25: LABOUR

- 25.1 (a) The contractor shall employ labour in sufficient numbers to maintain the required rate of progress and of quality to ensure workmanship of the degree specified in the contract and to the satisfaction of the Engineer-in-Charge. The Contractor shall not employ in connection with the works any person who has not completed eighteen years of age the minimum age specified in Indian Labour Law.
- (b) If any foreigner is employed by the contractor on the work within the site the later shall ensure that such foreigner possesses the necessary special permit issued by the Civil Authorities in writing and also comply with the instructions issued there-from from time to time. In the event of any lapse in this regard on the part of such foreigner the contractor shall be personally held responsible for the lapse & Authority shall not be liable in any event.
- (c) The Contract is liable for cancellation if either the contractor himself or any of his employee is found to be a person who has held Class-I post under the Authority immediately before retirement and has within two years of such retirement accepted without obtaining the previous permission of the Authority or of the Chairman as the case may be and employment as contractor for, or in connection with the execution of the public works, or as an employee of such contractor. If the contract is terminated on account of the failure of the contractor to comply with the above clause, the Authority shall be entitled to recover from him such damages as may be determined by the Engineer-in-Charge with due regard to the inconvenience caused to the Authority on account of such termination without prejudice to the Authority's right to proceed against such officer.
- 25.2 The contractor shall furnish and deliver fortnightly to the Engineer-in-Charge, a distribution return of the number and description by trades of the works of people employed on the works. The contractor shall also submit on the 4th and 19th of every month for the period of second half of the preceding month and first half of the current month respectively to the Engineer-in-Charge, a true statement in respect of the following.
- i) Any accident if occurred during the said fortnight showing the circumstances under which it happened and the extent of damage and injury caused by it and.
- ii) The number of female workers who have been allowed maternity benefit as provided in the Maternity Benefit Act 1961 or Rules made thereunder and the amount paid to them.
- 25.3 The Contractor shall pay to labourer employed by him either directly or through sub-contractors wages not less than wages as defined in Minimum Wages Act 1948 and Contract Labour (Regulation and Abolition) Act 1970 amended from time to time and rules framed there-under and other labour laws affecting contract labour that may be brought in force from time to time.
- 25.4 The Contractor shall also comply with the provisions of all Acts, Laws, any Regulation or Bye Laws of any Local or other Statutory Authority applicable in relation to the execution of works such as:
- i) Payment of Wages Act, 1936 (Amended)

- ii) Minimum Wages Act, 1948 (Amended).
- iii) The Contract Labour (Regulation & Abolition) Act, 1970 with Rules framed there under as amended.
- iv) Workmen Compensation Act, 1923 as amended by Amendment Act no.65 of 1976.
- v) Employer's Liability Act 1938 (Amended)
- vi) Maternity Benefit Act. 1961 (Amended)
- vii) The Industrial Employment (Standing orders) Act 1946 (Amended).
- viii) The Industrial Disputes Act. 1947 (Amended)
- ix) Payment of Bonus Act.1965 and Amended Act No. 43 of 1977 and No. 48 of 1978 and any amended thereof:
- x) The Personal Injuries (Compensation Insurance) Act 1963 and any modifications thereof and rules made thereunder from time to time. The Contractor shall take into account all the above and financial liabilities in his quoted rates and nothing extra, whatsoever, shall be payable to him on this account.

The list is indicative only, otherwise the contractor should be aware of all the Acts/Labour Laws and should follow diligently on the work. The contractor shall be fully and personally responsible for the violation of any Act/Labour Law

- 25.5 The Contractor shall be liable to pay his contribution and the employees contribution to the State Insurance Scheme in respect of all labour employed by him for the execution of the contract, in accordance with the provision of "the Employees State insurance Act 1948" as amended from time to time. In case the Contractor fails to submit full details of his account of labour employed and the contribution payable, the Engineer-in-Charge shall recover from the running bills the contribution amount as assessed by him. The amount so recovered shall be adjusted against the actual contribution payable for Employees State Insurance.
- 25.6 The Engineer-in-Charge shall on a report having been made by an inspecting officer as defined in the Contract Labour (Regulation and Abolition) Act and Rules or on his own in his capacity as Principal Employer, have the power to deduct from the amount due to the contractor any sum required for making good the loss suffered by worker(s) by reason of non-fulfilment of the conditions of the Contract for the benefit of Workers, non payment of wages or on account of deduction made from the wages of the workers which are not justified by the terms of the contract or non- observance of the said Act and Rules framed there under with amendments made from time to time.
- 25.7 The Contractor shall indemnify the Authority against any payments to be made under and for observance of the Regulation Laws, Rules as stipulated in Clause-25.4 above without prejudice to his right to claim indemnity from his sub-contractors. In the event of the contractor's failure to comply with the provisions of all the Acts/Laws stipulated in Clause-25.4 or in the event of decree or award or order against the contractor having been received from the competent authority on account of any default or breach or in connection with any of the provisions of the Acts/Laws/Rules mentioned in Sub-Clause 25.4 above, the Engineer-in-Charge without prejudice to any other right or remedy under the contract shall be empowered to deduct such sum or sums from the Bill of the contractor or from his security deposit or from other payment due under this contract or any other contract to satisfy within a reasonable time the provisions of the various Acts/Laws/Rules/Codes as mentioned under Sub-Clause 25.4 above, on the part of the contractor under the contract on behalf of and at the expenses of the contractor and make payment and /or provide amenities/ facilities/services accordingly. In this regard, the decision of the Engineer-in-Charge shall be conclusive and binding on the contractor.

- 25.8 In the event or the Contractor committing a default or breach of any of the provisions of the aforesaid Contract's Labour (Regulation and Abolition) Act and Rules as amended from time to time or furnishing any information or submitting or filling any form/Register/Slip under the provisions of these Regulations which is materially incorrect then on the report of the Inspecting officer as defined in the relevant Acts and Rules as referred in Clause 25.4 above, the Contractor shall without prejudice to any other liability pay to the Authority a sum not exceeding Rs.50/- (Rs. Fifty only) as liquidated damages for every default, breach or furnishing, making, submitting, filling materially incorrect statement as may be fixed by the Engineer-in-Charge. The decision of the Engineer-in-Charge in this respect shall be final & binding.
- 25.9 The Contractor shall at his own expenses comply with or cause to be complied with the Provisions/ Rules provided for welfare and health of Contract Labour in the Contract Labour (Regulation and Abolition) Act and other relevant Acts and Rules framed there under or any other instructions issued by the Authority in this regard for the protection of health and for making sanitary arrangements for workers employed directly or indirectly on the works. In case the contractor fails to make arrangements as aforesaid, the Engineer-in-Charge shall be entitled to do so and recover the cost thereof from the contractor.
- 25.10 The Contractor shall at his own expense arrange for the safety or as required by the Engineer-in-Charge, in respect of all labour directly or indirectly employed for performance of the Works and shall provide all facilities in connection therewith. In case the contractor fails to make arrangements and provide necessary facilities as aforesaid, the Engineer-in- Charge shall be entitled to do so and recover the cost thereof from the Contractor. But this will not absolve the contractor of his responsibility or otherwise thereof.
- 25.11 Failure to comply with "Provisions/Rules made for Welfare and Health of Contract Labour" Safety Manual, or the provisions relating to report on accidents and grant of maternity benefits to female workers and the relevant Acts/Rules referred in clause 25.4 above shall make the contractor liable to pay to the Authority as liquidated damages an amount not exceeding Rs. 50/- for each default or materially incorrect statement. The decision of the Engineer-in-Charge in such matters based on reports from the inspecting Officers as defined in the relevant Acts and Rules as referred in clause 25.4 above shall be final and binding and deductions for recovery of such liquidated damages may be made from any amount payable to the contractor. In the event of any injury, disability or death of any workmen in or about the work employed by the contractor either directly or through his sub-contractor, contractor shall at all time indemnify and save harmless the Authority against all claims, damages and compensation under the Workmen Compensation Act. 1923 as amended from time to time or in other Law for the time being in force and Rules there-under from time to time and also against all costs, charges and expenses of any smooth action by proceedings arising out of such accidents or injury, disability or death of a workmen and against all sum or sums which may with the consent of the contractor be paid to compromise or compound any claim in this regard. If any award, decree or order is passed against the contractor for recovery of any compensation under the Workmen Compensation Act, 1923, for any injury, disability or death of a workman by any competent court, the said sum or sums shall be deducted by the Engineer-in-Charge from any sum then due or that may become due to the contractor or from his security deposit or sale thereof in full or part under the contract or any other contract with the Authority towards fulfilment of the said decree, award or orders.
- 25.12 Provided always that the contractor shall have no right to claim payments/claims whatsoever on account of his compliance with his obligations under this clause and Labour Regulations.
- 25.13 The contractor shall not otherwise than in accordance with the statutes ordinance and Government Regulations or orders for the time being in force import, sell, give, barter or

otherwise dispose of any alcoholic liquor or drugs to permit or suffer any such import, sale, gift, barter or disposal by his sub-contractor, agent or employees.

- 25.14 The contractor shall not give, barter or otherwise dispose of to any person or persons any arms or ammunition of any kind or permit to suffer the same as aforesaid.
- 25.15 The Contractor shall employ for the execution of the works only such persons as are skilled and experienced in their respective trades and Engineer-in-Charge shall be at liberty to object to and require the contractor to remove from the works any persons employed by the Contractor for the execution of the works who, in the opinion of the Engineer-in-Charge, misconduct himself or is incompetent or negligent in the proper performance of his duties. The contractor shall forthwith comply with such requisition and such person shall not be again employed upon the works without permission of the Engineer-in-Charge.
- 25.16 **Release of Security deposit after labour clearance:** Security deposit of the work shall not be refunded till six month from the date of expired of the contract agreement. If any complaint is pending against the contractor in respect of the labour dispute for this work, then the same shall be met out by the contractor at his own level and risk & cost. If no complaint is pending on record till after three months after completion of work and/or no communication is received from Labour Officer to this effect till six months after the date of completion, it will be deemed to have no complained pending against the labour and the security deposit shall be released by IWAI.

CLAUSE – 26: MATERIALS OBTAINED FROM EXCAVATION SUCH AS COINS, FOSSILS, ETC.

- 26.1 Materials of any kind obtained from excavation on the site shall remain the property of the Authority and shall be disposed off as directed by the Engineer-in-Charge.
- 26.2 However if any of the materials thus obtained from excavation on the site is such as can be used in the execution of the work under the contract, the contractor will be allowed to use the same free of cost (except that any amount of royalty paid for in this regard by the Authority shall be recoverable from the contractor) for the aforesaid purpose provided the same is found suitable and is approved by the Engineer-in-Charge.
- 26.3 Fossils, coins, articles of value, structures and other remains or things of geological or archaeological interest discovered on the site shall be the absolute property of the Authority. The contractor shall take reasonable precautions to prevent his labour or any other person from removing or damaging any such article or thing and shall acquaint the Engineer-in-Charge with such discovery and carryout the Engineer-in-Charge's directions as to the disposal of the same at the expense of the Authority.

CLAUSE – 27: FORCE MAJEURE

- 27.1 The term Force Majeure shall herein mean Riots (other than among the contractor's employees), Civil Commotion (to the extent no insurable), war (whether declared or not), invasion, act of foreign enemies, hostilation, civil war, rebellion, revolution, insurrection, military or usurped power, damage from aircraft, nuclear fission, acts of God, such as earthquake (above 7 magnitude on Richter Scale), lightning, unprecedented floods, fires not caused by contractor's negligence and other such causes over which the contractor has no control and are accepted as such by the Engineer-in-Charge, whose decision shall be final and binding. In the event of either party being rendered unable by Force Majeure to perform any obligation required to be performed by them under this contract, the relative obligation of the party affected by such Force Majeure shall be treated as suspended for the period during which such Force Majeure cause lasts, provided the party allowing that it has been rendered unable as aforesaid, thereby shall notify within 15 days of the alleged beginning and ending thereof giving full particulars and satisfactory evidence in support of such cause.

- 27.2 For delays arising out of Force Majeure, the bidder shall not claim extension in completion date for a period exceeding the period of delay attributable to the causes of Force Majeure and neither the Authority nor the bidder shall be liable to pay extra costs provided it is mutually established that Force Majeure conditions did actually exist.
- 27.3 If any of the Force Majeure conditions exists in the places of operation of the bidder even at the time of submission bid, he shall categorically specify in his bid and state whether they have been taken into consideration in their quotations.

CLAUSE - 28: LIABILITY FOR DAMAGE, DEFECTS OR IMPERFECTIONS AND RECTIFICATION THEREOF

- 28.1 If the contractor or his labour or his sub-contractor, injure, destroy or damage, battery, solar panel, lighting system, road, fence, enclosures, water pipe, cables, buildings, drains, electricity or telephone posts, wires, trees, grass line, cultivated land in the area in which they may be working or in the area contiguous to the premises on which the work or any part of it is being executed or if any damage is caused to any item belonging to IWAI or to any person during the progress of work, the Contractor shall upon receipt of a notice in writing in that behalf from the Engineer-in-Charge, make good the same at his cost.
- 28.2 If it appears to the Engineer-in-Charge or his representative at any time during the progress of work or prior to the expiration of the Defects Liability period that any work has been executed with unsound, imperfect or unskilled workmanship or that any materials or articles provided by the Contractor for execution of the work are unsound or of a quality inferior to that contracted for, or otherwise not in accordance with the Contract, or that any defect, shrinkage or other faults found in the work arising out of defective design or defective/ improper materials or workmanship, the Contractor shall, upon receipt of a notice in writing in that behalf from the Engineer-in-Charge forthwith rectify or remove and reconstruct the work so specified in whole or in part, as the case may be, and/or remove the materials/articles so specified and provide other proper and suitable materials at his expense.
- 28.3 All damages caused by accidents or carelessness of the contractor or any of his employees or any property belonging to the Authority is wasted or is misused by the contractor or any of his employees shall be to the account of the contractor, who shall make good the loss.

CLAUSE - 29: CONTRACTOR'S LIABILITY AND INSURANCE

- 29.1 From commencement to completion of the work(s) as a whole, the Contractor shall take full responsibility for the care thereof and for taking precautions to prevent loss or damage. He shall be liable for any damage or loss that may happen to the works or any part thereof and to the Authority's Plant, Equipment and Material (hired or issued to the Contractor) shall be in good order and condition and in conformity in every respect with the requirements of the Contract and instructions of the Engineer-in-Charge.
- 29.2 i) Neither party to the contract shall be liable to the other in respect of any loss or damage which may occur or arise out of "Force Majeure" to the works or any part thereof on to any material or article at site but not incorporated in the works or to any person or anything or material whatsoever or either party provided such a loss or damage could not have been foreseen or avoided by a prudent person and the either party shall bear losses and damages in respect of their respective men and materials. As such liability of either party shall include claims/ compensations of the third party also.
- ii) Provided, however, in an eventuality as mentioned in sub-clause - 29.2 (i) above, the following provisions shall also have effect:

- (a) The Contractor shall, as may be directed in writing by the Engineer-in-Charge proceed with the completion of the works under and in accordance with the provisions and conditions of the contract, and
- (b) The Contractor shall, as may be directed in writing by the Engineer-in-charge, re-execute the works lost or damaged, remove from the site any debris and so much of the works as shall have been damaged and carry the Authority's T & P, Plant and Equipment, Material etc. to the Authority's store. The cost of such re-execution of the works, removal of damaged works and carrying of Authority's store shall be ascertained in the same manner as for deviations and this shall be ascertained in the same manner as for deviations and this shall be added to the contract sum. Provided always that the Contractor shall, at his own cost, repair and make good so much of the loss or damage as has been occasioned by any failure on his part to perform his obligations under the contract or not taking precautions to prevent loss or damage or minimise the amount of such loss or damage, Final assessment of loss or damage shall be decided by the Engineer-in-Charge and his decision shall be final and binding.
- 29.3 The contractor shall take special precautions to see that public places and roads adjacent to contractor's yard are not blocked at anytime either by his material or by his workmen. The roads are to be kept always clear and no equipment/materials shall be stacked.
- 29.4 The navigable waterways shall not be blocked by Contractor's vessels. The anchors dropped in the waterways shall be properly marked and removed after done with.
- 29.5 The contractor shall indemnify and keep indemnified the Authority against all losses and claims for death, injuries or damage to any person or any property whatsoever which may arise out of or in consequence of the construction and maintenance, of works during the contract period and also against all claims, demands, proceedings, damages, costs, charges and expenses whatsoever in respect of or in relation thereto, and such liabilities shall include claims/compensations of the third party.
- 29.6 (a) Before commencing execution of the work, the Contractor shall without in any way limiting his obligations and responsibilities under this condition, insure against any damage, loss or injury which may occur to any property (excluding that of the Authority but including the Authority building rented to the contractor wholly or in part and any part of which is used in part and any part of which is used by him for storing combustible materials) public liability by arising out of the carrying out of the contract. For this purpose the contractor shall take out, pay all costs and maintain throughout the period of his contract public liability with the following coverage.
- i) Public liability limits for bodily injury or death not less than Rs. 1,00,000 for one person and Rs. 2,00,000 for each accident.
- ii) Property liability limits for each accident not less than Rs. 1,00,000 ;
- iii) The Contractor shall prove to the Engineer-in Charge from time to time that he has taken out all the insurance policies referred to above and has paid the necessary premiums for keeping the policies alive till expiry of the Defects Liability Period.
- (b) The Contractor shall ensure that similar insurance policies are taken out by his sub-contractor (if any) and shall be responsible for any claims or losses to the Authority resulting from their failure to obtain adequate insurance protection in connection thereof. The Contractor shall produce or cause to be produced by his sub-contractors (if any) as the case may be, relevant, policy or policies and premium receipt as and when required by the Engineer-in-Charge.

- (b) If the contractor and/or his sub- contractor (if any) shall fail to effect and keep in force the insurance referred to above or any other insurance which he/they may be required to effect under the term of the Contract then and in any such case the Authority may, without being bound to effect and keep in force any such insurance and pay such premium or premiums as may be necessary for that purpose and from time to time deduct the amount so paid by the Authority from any moneys due or which may become due to the contractor or recover the same as a debt due from the contractor.
- (c) The contractor shall at his own expense arrange for the safety provisions as required in respect of the works covered under this contract as per the instruction of Engineer-in-charge. In case, the contractor fails to comply with the provisions of the safety the Engineer- in-Charge shall be entitled to and make the necessary arrangements at the risk and cost of the contractor. This will, however, not absolve the Contractor of his overall responsibility to execute the works under the contract.

CLAUSE – 30: SUSPENSION OF WORKS

- 30.1 The contractor shall on the receipt of order of the Engineer-in-Charge (whose decision shall be final and binding on the contractor) suspend the progress of the works or any part thereof for such time or times and in such manner as the Engineer-in-Charge may consider necessary.
- 30.2 The suspension of the work can be done by Engineer-in-Charge for any of the following reasons:
 - (a) On account of any default on the part of the contractor or
 - (b) for proper execution of the works or part thereof for the reasons other than the default of the contractor or
 - (c) for the safety of the works or part thereof.
- 30.3 The contractor shall during the suspension period, properly protect and secure the works to the extent necessary and carry out the instructions given in that behalf by the Engineer-in-Charge.
- 30.4 If the suspension is ordered for the reasons under the Clause 30.2(b) and (c) above, the contractor shall be entitled to the extension of time equal to the period of every such suspension Plus 25% for the completion of the item or group of items of work for which a separate period of completion is specified in the contract and of which suspended work forms a part

**CLAUSE – 31: FORECLOSURE OF CONTRACT IN FULL OR IN PART DUE
TO ABANDONMENT OR REDUCTION IN SCOPE OF WORK**

If at any time after acceptance of the tender the Authority decides to abandon or reduce the scope of the works for reason whatsoever and hence does not require the whole or any part of the works to be carried out, the Engineer-in-Charge (with the prior approval of competent authority mentioned in scheduled 'B') shall give notice in writing to that effect to the contractor and the Contractor shall have no claim to any payment of compensation or otherwise whatsoever, on account of any profit or advantage which he might have derived from the execution of the works in full but which he could not derive in consequence of the fore closure of the whole or part of the works.

CLAUSE – 32: TERMINATION OF CONTRACT ON DEATH

If the Contractor is an individual or a proprietary concern and the individual or the proprietor dies, or if the Contractor is a partnership concern and one of the partners dies, then, unless the Engineer-in-Charge is satisfied that the legal representatives of the individual contractor or of the proprietor of the proprietary concern and in the case of partnership, the surviving partners are capable of carrying out and completing the contract, the Engineer-in-Charge shall be entitled to terminate the Contract as to its incomplete part without the Authority being in anyway liable to payment of any compensation whatsoever on any account to the estate of the deceased Contractor and/or to the surviving partners of the Contractor's firm on account of termination of the Contract. The decision of the Engineer-in-Charge that the legal representatives of the deceased contractor or the surviving partners of the Contractor's firm cannot carry out and complete the works under the contract shall be final and binding on the parties. In the event of such termination, the Authority shall not hold the estate of the deceased Contractor and/or the surviving partners of the Contractor's firm liable for damages for not completing the contract. Provided that the power of the Engineer-in-Charge of such termination of contract shall be without prejudice to any other right or remedy which shall have accrued or shall accrue to him under the contract.

CLAUSE- 33: CARRYING OUT PART OF WORK AT THE RISK AND COST OF THE CONTRACTOR

33.1 If the contractor

- (i) At any time makes default during the currency of work or does not execute any part of the work with due diligence and continues to do so even after a notice in writing of 7 days in this respect from the Engineer-in-Charge; **or**
- (ii) Commits default in complying with any of the terms and conditions of the contract and does not remedy it or takes effective steps to remedy it within 7 days even after a notice in writing is given in that behalf by the Engineer-in-Charge; **or**
- (iii) Fails to complete the work (s) or items of work with individual dates of completion, on or before the date (s) so determined, and does not complete them within the period specified in the notice given in writing in that behalf by the Engineer-in-Charge.

33.2 The Engineer-in-Charge without invoking action under clause 36 may, without prejudice to any other right or remedy against the contractor which have either accrued or accrue thereafter to IWAI, by a notice in writing to take the part work/ part incomplete work of any item (s) out of his hands and shall have powers to:

- (a) Take possession of the site and any materials, constructional plant, implements, stores, etc., thereon; and/ or
- (b) Carry out the part work/ part incomplete work of any items (s) by any means at the risk and cost of the contractor.

33.3 The Engineer-in-Charge shall determine the amount, if any, is recoverable from the contractor for completion of the part work/ part incomplete work of any item (s) taken out of his hands and execute at the risk and cost of the contractor, the liability of contractor on account of loss or damage suffered by IWAI because of action under this clause shall not exceed 10% of the tendered value of the work.

33.4 In determining the amount, credit shall be given to the contractor with the value of work done in all respect in the same number and at the same rate as if it had been carried out by the original contractor under the terms of his contract, the value of contractor's materials taken over and incorporated in the work and use of plant and machinery belonging to the contractor. The certificate of the Engineer-in-Charge as to the value of work done shall be final and conclusive against the contractor provided always that action under this clause shall only be taken after giving notice in writing to the contractor. Provided also that if the expenses incurred by the IWAI are less than the amount payable to the contractor at his agreement rates, the difference shall not be payable to the contractor.

- 33.5 Any excess expenditure incurred or to be incurred by IWAI in completing the part work/ part incomplete work of any item (s) or the excess loss of damages suffered or may be suffered by IWAI as aforesaid after allowing such credit shall without prejudice to any other right or remedy available to IWAI in law or per as agreement be recovered from any money due to the contractor on any account, and if such money is insufficient, the contractor shall be called upon in writing and shall be liable to pay the same within 30 days.
- 33.6 If the contractor fails to pay the required sum within the aforesaid period of 30 days, the Engineer-in-Charge shall have the right to sell any or all of the contractors' unused materials, constructional plant, implements, temporary building at site etc. and adjust the proceeds of sale thereof towards the dues recoverable from the contractor under the contract and if thereafter there remains any balance outstanding, it shall be recovered in accordance with the provisions of the contract.
- 33.7 In the event of the above course being adopted by the Engineer-in-Charge, the contractor shall have no claim to compensation for any loss sustained by him by reason of his having purchased or procured any materials or entered into any engagements or made any advance on any account or with a view to the execution of the work or the performance of the contract.

CLAUSE - 34: COMPLETION TIME AND EXTENSIONS

- 34.1 The Engineer-in-Charge will make available to the contractor the site to enable the contractor to commence & proceed with the execution of the work in accordance with agreed programme. If there is any delay in making available any area of the work or the delays mentioned in Para 34.4, the competent authority as specified in schedule 'B' on the recommendations of the Engineer-in-Charge shall grant reasonable extension of time for completion of work. However, in case of the contracts having tendered value beyond Rs. 50 lakhs, if the total extension involved due to delay is upto 1/3rd of the stipulated period of completion then the Engineer-in-Charge shall decide the extension and convey the same to the contractor. But the contractor shall not claim any compensation whatsoever on this account.
- 34.2 If after the award of the work the contractor commits defaults in commencing the execution of work as aforesaid, Govt. shall without prejudice to any other right or remedy available in law, be at liberty to forfeit the earnest money & performance guarantee absolutely.
- 34.3 As soon as possible after the Contract is concluded, the Contractor shall submit a Time and Progress Chart get it approved by the Department. The Chart shall be prepared in direct relation to the time stated in the Contract documents for completion of items of the works. It shall indicate the forecast of the dates of commencement and completion of various trades of sections of the work.
- 34.4 However, if the work (s) be delayed by:-
- (i) Force majeure as per clause 27, or
 - (ii) Abnormally bad weather, or
 - (iii) Serious loss or damage by fire, or
 - (iv) Civil commotion, local commotion of workmen, strike or lockout, affecting any of the trades employed on the work, or
 - (v) Delay on the part of other contractors or tradesman engaged by Engineer-in-Charge in executing work not forming part of the contract, or
 - (vi) Non-availability of stores, which are the responsibility of Government to supply or
 - (vii) Non-availability of breakdown of Tools and Plant to be supplied or supplied by Government or

- (viii) Any other cause which, in the absolute discretion of the Engineer-in-Charge is beyond the Contractor's control.

then immediately upon the happening of any such events as aforesaid, the contractor shall inform the Engineer-in-Charge accordingly, but the contractor shall nevertheless use constantly his best endeavors to prevent and/or make good the delay and shall do all that may be required in this regard. The Contractor shall also request, in writing, for extension of time, to which he may consider himself eligible under the contract, within fourteen days of the date of happening of any such events as indicated above.

- 34.5 In case the cost of the work is more than 10 cores than the total scope of work will be divided into milestones. The contractor shall submit a Time & Progress chart for each milestone and get it approved by the competent authority.
- 34.6 Request for rescheduling of Mile stones and extension of time, to be eligible for consideration, shall be made by the Contractor in writing within fourteen days of the happening of the event causing delay on the prescribed form to the competent authority as indicated in Schedule 'B'. The Contractor may also, if practicable, indicate in such a request the period for which extension is desired.
- 34.7 In any such case as may have arisen due to any of the events, as aforesaid, and which may have been brought out by the contractor in writing, the Competent Authority mentioned in Scheduled 'B' may give a fair and reasonable extension of time, after taking into consideration the nature of the work delayed and practicability of its execution during the period of extension.
- 34.8 Such extensions shall be communicated to the contractor by the Engineer-in-Charge in writing. The contractor shall not be entitled to claim any compensation or over run charges whatsoever for any extension granted.

CLAUSE – 35: LIQUIDATED DAMAGES FOR DELAY

- 35.1 If the contractor fails to maintain the required progress in terms of clause 34 or to complete the work and clear the site on or before the date of completion as per the contract or extended date of completion, he shall, without prejudice to any other right or remedy available under the law to the authority on account of such breach, pay as agreed liquidated damages the amount calculated at the rates stipulated below.

- (i) Liquidated Damages @ 1.5 % per month of delay
for delay of work to be computed on per day basis

Provided always that the total amount of compensation for delay to be paid under this condition shall not exceed 10% of the Tendered Value of work.

The competent authority mentioned in Schedule 'B' (whose decision in writing shall be final & binding) may decide on the amount of tendered value of the work for every completed day/month (as applicable) that the progress remains below that specified in Clause 34 or that the work remains incomplete.

The amount of liquidated damages may be adjusted or set-off against any sum payable to the Contractor under this or any other contract with the authority.

- 35.2 In case of contracts having tendered amount more than 10 crores, if the contractor does not achieve a particular milestone mentioned in schedule 'B', or the re-scheduled milestone(s) in terms of Clause 34.6, the amount shown against that milestone shall be withheld, to be adjusted against the liquidated damages levied at

the final decision on Extension of Time. With-holding of this amount on failure to achieve a milestone, shall be automatic without any notice to the contractor. However, if the contractor catches up with the progress of work on the subsequent milestone(s), the withheld amount shall be released. In case the contractor fails to make up for the delay in subsequent milestone(s), amount mentioned against each milestone missed subsequently also shall be withheld. However, no interest, whatsoever, shall be payable on such withheld amount.

- 35.3 In case of contracts having tendered amount less than 10 crores, if the work remains incomplete after the stipulated date of completion, the Engineer-in-charge may withheld 10% of the tendered value of the work from the running payments of the contractor pending final decision of the competent authority mentioned in schedule 'B' on the extension of time case. If the competent authority decides to grant extension of time without levy of liquidated damages or levy part of the total liquidated damages specified above then the balance withheld amount after adjusting the amount of the liquidated damages levied by the competent authority will be refunded to the contractor.

CLAUSE – 36: WHEN THE CONTRACT CAN BE DETERMINED

- 36.1 Subject to other provisions contained in this clause, the Engineer-in-Charge may, without prejudice to his any other rights or remedy against the contractor in respect of any delay, inferior workmanship, any claims for damages and/or any other provisions of this contract or otherwise, and whether the date of completion has or has not elapsed, by notice in writing absolutely determine the contract in any of the following cases:
- (i) If the contractor having been given by the Engineer-in-Charge a notice in writing to rectify, reconstruct or replace any defective work or that the work is being performed in an inefficient or otherwise improper or unworkman like manner shall omit to comply with the requirement of such notice for a period of seven days thereafter.
 - (ii) If the contractor has, without reasonable cause, suspended the progress of the work or has failed to proceed with the work with due diligence so that in the opinion of the Engineer-in-Charge he will be unable to secure completion of the work by the date for completion and continues to do so after a notice in writing of seven days from the Engineer-in-Charge.
 - (iii) If the contractor fails to complete the work within the stipulated date or items of work with individual date of completion, if any stipulated, on or before such date(s) of completion and does not complete them within the period specified in a notice given in writing in that behalf by the Engineer-in-Charge.
 - (iv) If the contractor persistently neglects to carry out his obligations under the contract and/ or commits default in complying with any of the terms and conditions of the contract and does not remedy it or take effective steps to remedy it within 7 days after a notice in writing is given to him in that behalf by the Engineer-in-Charge.
 - (v) If the contractor shall offer or give or agree to give to any person in IWAI service or to any other person on his behalf any gift or consideration of any kind as an inducement or reward for doing or forbearing to do or for having done or forborne to do any act in relation to the obtaining or execution of contract.
 - (vi) If the contractor shall enter into a contract with IWAI in connection with which commission has been paid or agreed to be paid by him or to his knowledge, unless the particulars of any such commission and the terms of payment thereof have been previously disclosed in writing to the Engineer-in-Charge.

- (vii) If the contractor shall obtain a contract with IWAI as a result of wrong tendering or other non-bonafide methods of competitive tendering or commits breach of integrity pact.
- (viii) If the contractor being an individual, or if a firm, any partner thereof shall at any time be adjudged insolvent or have a receiving order or order for administration of his estate made against him or shall take any proceedings for liquidation or composition (other than a voluntary liquidation for the purpose of amalgamation or reconstruction) under any Insolvency Act for the time being in force or make any conveyance or assignment of his effects or composition or arrangement for the benefit of his creditors or purport so to do, or if any application be made under any Insolvency Act for the time being in force for the sequestration of his estate or if a trust deed be executed by him for benefit of his creditors.
- (ix) If the contractor being a company shall pass a resolution or the court shall make an order that the company shall be wound up or if a receiver or a manager on behalf of a creditor shall be appointed or if circumstances shall arise which entitle the court or the creditor to appoint a receiver or a manager or which entitle the court to make a winding up order.
- (x) If the contractor shall suffer an execution being levied on his goods and allow it to be continued for a period of 21 days.
- (xi) If the contractor assigns, transfers, sublets (engagement of labour on a piece-work basis or of labour with materials not to be incorporated in the work, shall not be deemed to be subletting) or otherwise parts with or attempts to assign, transfer, sublet or otherwise parts with the entire works or any portion thereof without the prior written approval of the Engineer -in-Charge.

When the contractor has made himself liable for action under any of the cases aforesaid, the Engineer-in-Charge on behalf of the IWAI with the approval of the competent authority mentioned in schedule 'B' shall have powers:

- (a) To determine the contract as aforesaid (of which termination notice in writing to the contractor under the hand of the Engineer-in-Charge shall be conclusive evidence). Upon such determination, the Earnest Money Deposit, Security Deposit already recovered and Performance Guarantee under the contract shall be liable to be forfeited and shall be absolutely at the disposal of the IWAI.
- (b) After giving notice to the contractor to measure up the work of the contractor and to take such whole, or the balance or part thereof, as shall be un-executed out of his hands and to give it to another contractor to complete the work. The contractor, whose contract is determined as above, shall not be allowed to participate in the tendering process for the balance work.

In the event of above courses being adopted by the Engineer-in-Charge, the contractor shall have no claim to compensation for any loss sustained by him by reasons of his having purchased or procured any materials or entered into any engagements or made any advances on account or with a view to the execution of the work or the performance of the contract. And in case action is taken under any of the provision aforesaid, the contractor shall not be entitled to recover or be paid any sum for any work thereof or actually performed under this contract unless and until the Engineer-in-Charge has certified in writing the performance of such work and the value payable in respect thereof and he shall only be entitled to be paid the value so certified.

CLAUSE – 37: INSPECTION AND APPROVAL

- 37.1 All works involving more than one process shall be subject to examination and approval at each stage thereof and the contractor shall give due notice to the Engineer-in-Charge on his authorized representative, when each stage is ready. In default of such notice, the Engineer-in-Charge shall be entitled to appraise the quality and extent thereof and the decision of the Engineer-in-Charge in this regard shall be final and binding.
- 37.2 No work shall be put out of view without the approval of the Engineer-in-Charge or his authorized representative and the Contractor shall afford full opportunity for examination. The contractor shall give due notice to the Engineer-in-Charge or his authorized representative whenever any such work is ready for examination and the Engineer-in-Charge or his representative shall, without unreasonable delay, unless he considers it necessary and advise the contractor accordingly, examine and measure such work. In the event of the failure or the contractor to give such notice, he shall if required by the Engineer-in-Charge, uncover such work at the contractor's expenses.
- 37.3 Periodic inspection will be carried out by the EIC or his representative by their vessels. The contractor can have the inspection schedules finalized with the Engineer-in-charge. Generally all attempts should be made to have joint inspection and number of inspections be not less than three in a calendar month.

CLAUSE – 38: COMPLETION CERTIFICATE AND COMPLETION PLANS

- 38.1 The work shall be completed to the entire satisfaction of the Engineer-in-Charge and within the specified time limit and under the terms and conditions of the contract. As soon as the work under the contract is completed as a whole the contractor shall give notice of such completion to the Engineer-in-Charge. The Engineer-in-Charge shall inspect the work and shall satisfy himself that the work(s) has been completed in accordance with the provisions of the contract and then issue to the Contractor a certificate of completion indicating the date of completion. Should the Engineer-in-Charge notice that there are defects in the works or the works are not considered to be complete, he shall issue a notice in writing to the Contractor to rectify / replace the defective work or any part thereof or complete the work, as the case may be within such time as may be notified and after the contractor has complied with as aforesaid and gives notice of completion the Engineer-in-Charge shall inspect the work and issue the completion certificate in the same manner as aforesaid.
- 38.2.1 No certificate of completion shall be issued as stipulated above and no work be considered to be completed unless the contractor shall have removed from the work site and / or premises all his belongings / temporary arrangements brought / made by him for the site and / or premises in all respects and made the whole of the site and / or premises fit for immediate occupation / use to the satisfaction of the Engineer-in-Charge. If the contractor fails to comply with the above mentioned requirements on or before the date of completion of the work, the Engineer-in-Charge, may as he thinks fit and at the risk at cost of the contractor, fulfill such requirements and remove / dispose of the contractor's belongings / temporary arrangements, as aforesaid, and the contractor shall have no claim in this respect except for any sum realised by the sale of Contractor's belongings / temporary arrangements less the cost of fulfilling the said requirements and any other amount that may be due from the contractor. Should the expenditure on the aforesaid account exceed the amount realised by sale of such contractor's belongings / temporary arrangements then the contractor shall on demand pay the amount of such excess expenditure.
- 38.2.2 The contractor shall submit the completion plans of the work wherever required within 30 days of the completion of work. In case the contractor fails to submit completion plans as aforesaid, he shall be liable to pay a sum equivalent to 2.5% of the value of

the work subject to a ceiling of Rs.15000/- (Rupees fifteen thousand only) as may be fixed by Engineer-in-Charge concerned and in this respect the decision of the Engineer-in-Charge shall be final and binding on the contractor.

CLAUSE - 39: MEASUREMENTS

- 39.1 The Engineer-in-charge shall, except as otherwise provided, ascertain and determine by measurement the value of work done in accordance with the contract.
- 39.2 Notwithstanding any provision in the relevant standard method of measurement or any general or local custom, measurement of work done under the contract shall be taken in accordance with the procedure set forth in the Technical Specifications or Schedule of Quantities under the contract. In case of items of work which are not covered by the Technical Specifications or Schedule of Quantities measurement shall be taken in accordance with the relevant standard methods of measurement laid down by the Bureau of Indian Standard.
- 39.3 All items having a financial value shall be entered in daily log book/ measurement book prescribed by the Authority so that the complete work performed under the contract is duly accounted.
- 39.4 Measurement shall be taken jointly by the Engineer-in-Charge or his authorised representative and by the contractor or his authorised representative.
- 39.5 Before taking measurements of any works, the Engineer-in-Charge or representative deputed by him for the purpose, shall give a reasonable notice to the Contractor. If the Contractor fails to attend or send an authorised representative for measurement after such notice or fails to countersign or to record the objection within a week from the date of taking the measurements, in such eventuality the measurements taken by the Engineer-in-Charge shall be taken to be correct and final measurements of such works.
- 39.6 The contractor shall, without extra charge, provide assistance with every appliance, labour and other things necessary for measurement.
- 39.7 Measurements shall be signed and dated by both parties each day on the Site on completion of measurement. If the contractor objects to any of the measurement recorded by the representative of the Engineer-in- Charge a note to the effect shall be made in the item objected to and such note shall be signed and dated by both parties engaged in taking the measurement. The decision of the Engineer-in-Charge on any such dispute or difference or interpretation shall be final and binding on the contractor in respect of all contract items, substituted items, extra items and deviations.

CLAUSE – 40: PAYMENT ON ACCOUNT

- 40.1 Interim bills shall be submitted by the contractor monthly on or before the date fixed by the Engineer-in- Charge for the items of work completed. The Engineer-in-Charge shall then arrange to have the bills verified with reference to the measurements recorded in the measurement book(s).
- 40.2 Payment on account for amount admissible shall be made by the Engineer-in-Charge certifying the sum to which the contractor is considered entitled by way of interim payment for the work executed, after deducting therefrom the amount already paid, the security deposit and such other amounts as may be withheld, deductible or recoverable in terms of the contract.
- 40.3 Payment of the contractor's bills shall be made by the Authority only in Indian Rupees within 30 days from the date of submission of the bill subject to the acceptance of the Engineer-in- Charge.

- 40.4 Payments due to the contractor shall be made by crossed cheque by the Engineer-in-Charge or his authorised representative. Such cheques shall be issued direct to the contractor on furnishing a stamped receipt for the amount of the cheque or to his constituted attorney duly authorised to receive such payments from the EIC.
- 40.5 Any interim certificate given relating to work done or materials delivered may be modified or corrected by any subsequent interim certificate or by the final certificate. No certificate(s) of the Engineer-in-Charge supporting an interim payment shall itself be conclusive evidence that any work or materials to which it relates is / are in accordance with the same.
- 40.6 Should there be a request for extension of date of completion, pending its consideration interim payments shall continue to be made as provided herein.
- 40.7 TDS at the applicable rates shall be deducted at source from any payment made to the contractor against this contract.

CLAUSE – 41: TAXES, DUTIES AND LEVIES ETC.

- 41.1 The prices shall include all the taxes, levies, cess, octroi, royalty, terminal tax, excise, except GST as applicable or any other local, State or Central taxes as applicable/charged by Centre or State Government or Local authorities on all materials that the contractor has to purchase for the performance of the contract and services, shall be payable by the contractor and the Authority will not entertain any claim for compensation whatsoever in this regard. The rates quoted by the contractor shall be deemed to be inclusive of all such taxes, duties, levies, etc except GST as applicable. However, GST as applicable shall be reimbursed only on production of proof its remittance.

CLAUSE-42: TAX DEDUCTION AT SOURCE

- 42.1 TDS at the applicable rate as per Income Tax Act/Rules shall be deducted from all the payment/advances made against the contract.

CLAUSE – 43: PAYMENT OF FINAL BILL

The final bill shall be submitted by the contractor within one month from the date of completion of the work or of the date the certificate of completion furnished by the Engineer-in-Charge. No further claim in this regard unless as specified herein under shall be entertained. Payment of final bill shall be made within three months if the amount of the contract is up to Rs. 15 lakhs and six months if the value of the work exceeds Rs. 15 lakhs. If there shall be any dispute about any item or items of the work then the undisputed item or items only shall be paid within the said period of three months or six months, as the case may be. The contractor shall submit a list of the disputed items within thirty days from the disallowance thereof and if he fails to do so, his claim shall be deemed to have been fully waived and absolutely extinguished.

CLAUSE - 44: OVER PAYMENTS AND UNDER PAYMENTS

- 44.1 Whenever any claim whatsoever for the payments of a sum of money to the Authority arises out of or under this contract against the contractor, the same may be deducted by the Authority from any sum then due or which at anytime thereafter may become due to the contractor under this contract and failing that under any other contract with the Authority or from any other sum whatsoever due to the contractor from the Authority or from his security deposit, or he shall pay the claim on demand.
- 44.2 The Authority reserves the right to carry out post- payment audit and technical examination of the final bill including all supporting vouchers, abstracts, etc. The

authority further reserves the right to enforce recovery of any over payment when detected notwithstanding the fact that the amount of the final bill may be included by one of the parties as an item of dispute before an arbitrator appointed under clause 48 of this contract and notwithstanding the fact that the amount of the final bill figures in the arbitration award.

- 44.3 If as a result of such audit and technical examination any over payment is discovered in respect of any work done by the contractor or alleged to have been done by him under contract, it shall be recovered by the Authority from the contractor by any of all of the methods prescribed above, and if any under payment is discovered, the amount shall be duly paid to the contractor by the Authority.
- 44.4 Provided that the aforesaid right of the Authority to adjust over-payment against amount due to the contractor under any other contract with the Authority shall not extend beyond the period of two years from the date of payment of the final bill or in case the final bill is a MINUS bill, from the date the amount payable by the Contractor under the MINUS final bill is communicated to the contractor.
- 44.5 Any sum of money due and payable to the Contractor (including the security deposit returnable to him) under the contract may be withheld or retained by way of lien by the Engineer-in-Charge or Authority against any claim of the Authority or such other person or persons in respect of payment of a sum of money arising out of or under any other contract made by the contractor with the Engineer-in-Charge or Authority or with such other person or persons. The sum of money so withheld or retained under this clause by the Engineer-in-Charge or Authority will be kept withheld or retained as such by the Engineer-in-Charge or Authority or till his claim arising out of in the same contract or any other contract is either mutually settled or determined by the arbitrator, if the contract is governed by the arbitration clause under the clause 48 or by the competent court hereinafter provided, as the case may be, and the contractor shall have no claim for interest or damages whatsoever on this account or any other ground in respect of any sum of money withheld or retained under this clause.

CLAUSE – 45: FINALITY CLAUSE

It shall be accepted as an inseparable part of the contract that in matters regarding design, materials, workmanship, removal of improper work, interpretation of the contract drawings and contract specifications, mode of procedure and the carryout out of the work the decision of the Engineer-in-Charge which shall be given in writing shall be final and binding on the contractor.

CLAUSE – 46: SUM PAYABLE BY WAY OF COMPENSATION TO BE CONSIDERED IS REASONABLE WITHOUT PREFERENCE TO ACTUAL LOSS

All sum payable by way of compensation to the Authority under any of these conditions shall be considered as reasonable compensation without reference to the actual loss or damage sustained and whether or not damage shall have been sustained.

CLAUSE - 47: SETTLEMENT OF DISPUTES & ARBITRATION.

- 47.1 Except where otherwise provided in the contract, all questions and disputes relating to the meaning of the specifications, design, drawings and instructions here-in-before mentioned and as to the quality of workmanship or materials used on the work or as to any other question, claim, right, matter or thing whatsoever in any way arising out of or relating to the contract, design, drawings, specifications, estimates, instructions, orders or these conditions or otherwise concerning the works or the execution or failure to execute the same whether arising during the progress of the work or after the cancellation, termination, completion or abandonment thereof shall be dealt with as mentioned hereinafter:

- (i) If the contractor considers any work demanded of him to be outside the requirements of the contract, or disputes any drawings, record or decision given in writing by the Engineer-in-Charge on any matter in connection with or arising out of the contract or carrying out of the work, to be unacceptable, he shall promptly within 15 days of the receipt of decision from the Engineer-in-Charge request the Chief Engineer in writing through the Engineer-in-Charge for written instruction or decision. Thereupon, the Chief Engineer shall give his written instructions of the decision within a period of one month from the receipt of the contractor's letter. However, this will not be reason for the stoppage of work.
- (ii) If the Chief Engineer fails to give his instructions or decision in writing within the aforesaid period or if the contractor is dissatisfied with the instruction or decision of the Chief Engineer, the contractor may, within 15 days of the receipt of Chief Engineer's decision, appeal to the Chairman, IWAI who shall afford an opportunity to the contractor to be heard, if the latter so desires, and to offer evidence in support of his appeal. The Chairman, IWAI shall give his decision within 30 days of receipt of contractor's appeal. If the contractor is still dissatisfied with his decision, the contractor shall within a period of 30 days from receipt of the decision, give notice to the Chairman, IWAI for appointment of arbitrator on prescribed proforma as per Appendix V, failing which the said decision shall be final binding and conclusive and not referable to adjudication by the arbitrator.

47.2 Except where the decision has become final, binding and conclusive in terms of Sub Para 47.1 above, disputes or differences shall be referred for adjudication through arbitration by a sole arbitrator appointed by Chairman, IWAI.

47.3 Further, within thirty (30) days of receipt of such notice from either party, the Engineer-in-Charge of work at the time of such dispute shall send to the Contractor a panel of three persons preferably but not necessarily from the approved panel of arbitrators being maintained by Indian Council of Arbitration (ICA) and thereafter the Contractor within fifteen (15) days of receipt of such panel communicate to the Engineer-in-charge the name of one of the persons from such panel and such a person shall then be appointed as sole arbitrator by the Chairman, IWAI. However, the arbitrator so appointed shall not be an officer or the employee of Inland Waterways Authority of India.

Provided that if the Contractor fails to communicate the selection of a name out of the panel so forwarded to him by the Engineer-in-charge then after the expiry of the aforesaid stipulated period the Chairman, shall without delay select one person from the aforesaid panel and appoint him as the sole arbitrator.

47.4 The arbitrator to whom the matter is originally referred being transferred or vacating his office or being unable to act for any reason, then the Chairman IWAI shall appoint another person to act as sole arbitrator, such person shall be entitled to proceed with the reference from the stage at which it was left by the predecessor.

47.5 The award of the Arbitrator shall be final and binding. The Arbitrator shall decide in what proportion the Arbitrator's fees, as well as the cost of Arbitration proceeding shall be borne by either party.

47.6 The Arbitrator with the consent of the parties can enlarge the time, from, time-to-time to make and publish his award.

47.7 A notice of the existence in question, dispute or difference in connection with the contract unless served by either party within 30 days of the expiry of the defects

liability period, failing which all rights and claim under this contract shall be deemed to have been waived and thus forfeited and absolutely barred.

- 47.8 The Arbitrator shall give reasons for the award if the amount of claim in dispute is Rs. 1,00,000/- and above.
- 47.9 The work under this Contract shall continue during Arbitration proceedings and no payments due from or payment by the Authority shall be withheld on account of such proceedings except to the extent which may be in dispute.
- 47.10 The Arbitration and Conciliation Act 1996 with any statutory modifications or re-enactment thereof and the rules made there under and being in force shall apply to the Arbitration proceedings under this clause.
- 47.11 The parties to the agreement hereby undertake to have recourse only to arbitration proceedings under for Arbitration Act 1996 and the venue of the arbitration proceeding shall be Kolkata and the parties will not have recourse to Civil Court to settle any of their disputes arising out of this agreement except through arbitration.

NOTE: In case of contract with another Public Sector Undertaking, following Arbitration Clause shall apply: "Except as otherwise provided, in case of a contract with a public Sector Undertaking if at any time any question dispute or difference whatsoever arises between the parties upon or in relation to, or in connection with this agreement, the same shall be settled in terms of the Ministry of Industry, Department of Public Enterprises O.M No. 3/5/93-PMA dt.30.06.93 or any modifications / amendments thereof. "The arbitrator shall have the power to enlarge the term to publish the award with the consent of the parties provided always that the commencement or continuation of the arbitration proceeding shall not result in cessation or suspension of any of other rights and obligations of the parties of any payments due to them hereunder.

CLAUSE - 48 : CLAIMS

- 48.1 The contractor shall send to the Engineer-in-Charge once in every month on account giving particulars, as full and detailed as possible of all claims for any additional payment to which the contractor may consider himself entitled and of all extra work or additional work ordered in writing and which has been executed during proceeding month.
- 48.2 No claim for payment of any extra work or expenses will be considered which has not been included in such particulars. The Engineer-in-Charge may consider payment for any such work or expense, where admissible under the terms of the Contract.
- 48.3 Any claim which is not notified in two consecutive monthly statements for the two consecutive months shall be deemed to have been waived & extinguished.

SPECIAL CONDITIONS OF CONTRACT (SCC)

1. General

- 1.1. SCC shall be read in conjunction with the GCC, specification, ToR, Drawings and any other documents forming part of this contract wherever the context so requires.
- 1.2. Notwithstanding the sub-division of the documents in to these separate section and volume, every part of each shall be deemed to be supplementary to and complementary of every other part and shall be read with and as a part of the Contract.
- 1.3. Where any portion of the GCC is repugnant to or at variance with any provisions of the Special Conditions, the provisions of the SCC shall be deemed to over-ride the provisions of the GCC.
- 1.4. Where it is mentioned in the Specification, that the Contractor shall perform certain work or provide certain facilities, it is understood that the Contractor shall do so at his own cost.
- 1.5. The materials and workmanship shall satisfy the relevant standards as stipulated under the Contract Agreement, the specification conditioned herein and codes referred to. Where the specifications stipulate requirement in addition to those contained in the Standard codes and specifications, these additional requirements shall also be satisfied by the Contractor.

2. The Site

2.1 General Site Information

The Contractor shall visit the site and satisfy themselves on the actual site conditions, meteorological and other data, before tendering. Whatever information and other relevant data given in the tender document are only intended as a general guidance for the Contractor and no warranty is given for the correctness of the same.

2.2 Condition of Site

The Contractor, before carrying out any work, shall inspect the Site in conjunction with the EIC to establish its general condition which shall be agreed and recorded in writing, and where, in the opinion of the EIC or his representative it is deemed necessary, by means of photography.

The boundary of the land earmarked for the execution of the Works shall be defined by the Engineer's Representative and the Contractor shall provide, erect and maintain from commencement to final completion of all work and all reinstatement substantial galvanized pipes or similar approved markers indicating the boundary of the working area at regular intervals as the Engineer's Representative may require. In the event of any such boundary marker / post being disturbed or displaced as a result of the Contractor's operations or theft, the Contractor shall forthwith at his own expense replace the same and maintain the boundary properly.

Order of Works: The order in which the works are to be carried out by the Contractor shall be to the approval of Employer and shall be such as to suit the detailed method of construction, adopted by the Contractor as well as the Work Plan / Overall Schedule approved by the Employer. The works shall be carried out in such a manner so as to enable the other Contractors to work concurrently so that the entire project may be brought into use immediately after the completion of works.

3. General Conditions of Construction and Erection Work

- 3.1 The work shall be permitted on the site round the clock.
- 3.2 The contractor must arrange for the placement of workers in such a way that the delayed completion of the works of any part thereof for any reason whatsoever will not affect their proper employment. The Employer will not entertain any claim for over time /idle time payment etc. whatsoever.
- 3.3 The Contractor shall submit to Employer / EIC reports at regular intervals regarding the state and progress of work. The details and proforma of the report will be mutually agreed after the award of Contract.

4. Surveys and Levels

- 4.1 Before the works of any part thereof begin, the Contractor shall survey and take levels of the site of the works both above and below water level / Chart Datum level, and agree all particulars on which the measurements of the works are to be based. Such particulars shall be recorded and after agreement; the drawings shall be signed by the Employer / Engineer-In-Charge and the Contractor.
- 4.2 Failing such surveys and agreements being prepared and/or signed by the Contractor, the survey carried out by the EIC shall be final and binding on the Contractor.

5. Setting out the Works

- 5.1 The Employer shall furnish the relevant existing grid points with Bench Mark with reference to permanent bench marks. It shall be Contractor's responsibility to set out the necessary central points on land and to set out alignment. The Contractor shall have in his employees, an efficient survey team for this purpose and the accuracy of such setting out works shall be Contractor's sole responsibility.
- 5.2 Before beginning the work the Contractor shall work out the control points on ground which, are pre requisite for carrying out hydrographic surveys, accurately, with suitable markers as approved by Employer. All these points and markings shall be checked and approved by Employer's Representative before starting the work.
- 5.3 The Contractor shall also provide necessary equipment, labour and other facilities for proper checking and inspection of the fabrication, welding, painting and any other such activity forming part of the total scope of the work at no cost to the Employer.
- 5.4 The Contractor shall give Employer not less than 24 hours' notice in writing of his intention to inspect for any part of the works so that arrangements may be made for checking the work.
- 5.5 The Contractor shall at his own expense provide all assistance which Employer or his representative may require for checking and inspection.

6. Conditions for work

- 6.1 The decision of EIC to accept the work done with or without the LD shall be final and binding.
- 6.2 No idle time charges will be paid to the Contractor on any account.
- 6.3 The Employer / EIC or his representative will inspect, co-ordinate, measure and certify the work. He has the right to inspect at any time during the contract period for which contractor's authorized representative shall be available at site during such inspection.
- 6.4 The Contractor may execute the work round the clock and on all days including Sundays and Public Holidays except National Holidays subject to such restriction as may be imposed by State Government /local body or EIC.

- 6.5 If the Contractor's personnel or any outside labour employed to work during execution of Contract, breaks or damages/destroys any vessel, craft, net, fishing stakes etc. building, road, kerb, water pipe, fence, bund, wires, trees, crop, fruit or cultivated ground during the period of agreement, the same shall be made good by the Contractor at his own expenses or in default, the Employer may cause the same to be made good by other sources and deduct the expenses from any sums that may be then or at any time thereafter may become due to the contractor.
- 6.6 The rate quoted shall include all taxes, duties and any other levies. No additional payment on any such account shall be payable by the Employer. However, the GST shall be paid as per existing rules and regulations at the time of payment.
- 6.7 The right to award/split up work or to reject the offer without assigning any reason is reserved with the Authority.
- 6.8 If the work is stopped continuously for more than 3 days due to law and order, the Contractor has to report to EIC the same and take actions mutually in accordance with prevailing local laws for removal of such problem and proceeding further with the work to mutual benefit.
- 6.9 Any charge incurred for adopting environmental safe guards, minimizing detrimental impacts, enhancing the beneficial aspects of the project and for effective management of the environmental resources affected by the project shall be met by the Contractor. No additional charges on any account shall be payable by IWAI.

7. Standard and Standard Products

7.1 Standards

Save in so far otherwise specified in the Contract the relevant provisions of the appropriate Bureau of Indian Standards shall apply for all materials and workmanship. Where relevant BIS standards do not exist, the latest version of the relevant standards in vogue shall be applied. Where both above Standards may not be available, the following Standards shall also be referred to and adopted.

- BS : British Standard Specification
- CP : British Standard Code of Practice
- ASTM : Standard of American Society for Testing Materials.

8. Standard Products

If mention is made in the Contract of named products of individual manufacturers, this is an indication of the standard type and workmanship of goods, which are satisfactory to the EIC. The Contractor may substitute similar products of at least equal quality and suitability, subject to the approval of the EIC.

Proposals by the Contractor for the supply of manufactured products shall be accompanied by certification that the manufacturer's products are approved by the relevant standards authority.

9. Security and Safety

- 9.1 The Contractor shall comply with all regulations imposed by the Central / State / Local Authorities and Employer in respect of the passage of Plant, Vehicles, materials and personnel through waterways.
- 9.2 The Contractor shall take all possible precautions to prevent out breaks of fire on the site and in all offices, stores, camps and other places and things connected therewith and especially with respect to the safe storage of petroleum products, explosives and all other dangerous or hazardous goods. The Contractor shall comply with all rules, regulations and orders of any Statutory Authority and of Employer at no extra cost to the Employer.

9.3 The Contractor shall obtain from the Employer details of any restricted areas in or around the site and shall have prominently and clearly displayed for the information of his staff and work people notices defining any such restricted areas. Such notices shall be provided at his own expenses.

9.4 If required, the Contractor shall take entry passes to the restricted areas for all personnel labourers and vehicle. No claim whatsoever on this account will be entertained.

10. Health Safety and Environment, Risk & Hazard

10.1 The Contractor shall prepare and submit to the Employer / EIC, the Health Safety and Environment (HSE) Plan in line with Employers HSE policy and Contractors company policy within 28 days of commencing of works for the approval of the Employer. The policy shall be followed during the life cycle of the project. The policy may be updated as and when required.

10.2 The Contractor shall prepare and submit the Risk & Hazard identification and mitigation plan within 28 days of commencing of works for approval of the Employer. The plan may be updated as and when required.

11. Taxes, duties and levies etc.

The prices shall include all the taxes, levies, cess, octroi, royalty, terminal tax, excise or any other local, State or Central taxes as applicable/ charged by Centre or State Government or Local authorities on all materials that the contractor has to purchase for the performance of the contract and services, shall be payable by the contractor and the Authority will not entertain any claim for compensation whatsoever in this regard. The rates quoted by the contractor shall be deemed to be inclusive of all such taxes, duties, levies, etc except GST as applicable.

A. HOLD HARMLESS:

- i) The Contractor should indemnify and hold the Authority harmless from any liability or claim for damages because of bodily injury, death, property damage, sickness, disease or loss and expense arising from the Contractor's performance of this Contract.
- ii) The Contractor is acting in the capacity of an independent contractor with respect to the Authority.
- iii) The Contractor should protect, defend and indemnify the Owner from any claims by labours or Sub Contractors for unpaid work or labour performed in connection with this Contractor.

B. CHANGE ORDERS:

- i) The Contractor should not make any changes in the schedule of work or the Specifications without written authorization by the Engineer-in-Charge and written concurrence by the Authority.

C. UNSATISFACTORY PERFORMANCE:

- i) In case of unsatisfactory performance/ progress / services by the Contractor, IWAI shall have the right to issue a show cause notice to the consultant requiring him to explain the reason thereof.
- ii) In case of continuation of such unsatisfactory performance / progress / services, IWAI reserves the right to rescind the Contract and get the balance work executed at the risk and cost of the Contractor.

D. WARRANTIES:

- i) The Contractor should warrant that this contract does not and shall not infringe any existing or subsequent patents, rights or licenses of any third party.

ii)The Contractor should further warrant that the rights of the Authority under the present contract are not and shall not be infringed by any prior or subsequent contract, which may have been or may hereafter be entered into by the Contractor with any other party.

E. Duration work: The entire work shall be completed in all respect within 75 (seventy five) days after handing over the site.

F.MISCELLANEOUS:

i)The Contract embodies the entire understanding of the parties as to its subject matter and shall not be amended except in writing executed by both the parties and subject to the approval of the concerned authorities.

TECHNICAL SPECIFICATIONS & SPECIAL CONDITIONS

1. Scope of work and Technical specification:-

Erection of RCC poles

- A. Earth work in excavation by mechanical means (Hydraulic excavator)/ manual means over areas (not exceeding 1.5 m in width or 10 sqm on plan) including getting out and disposal of excavated earth lead upto 50 m and lift upto 1.5 m, as directed by Engineer-In-Charge.
- B. Providing and laying in position cement concrete of specified grade excluding the cost of centering and shuttering. All work upto plinth level 1:1.5:3 (1 cement, 1:5 coarse sand (Zone-III), 3 graded stone aggregate 20mm nominal size all completed as per specification & direction of EIC.
- C. Supplying of RCC standards post of mixing 1:1.5:3 (1 cement, 1:5 coarse sand (Zone-III), 3 graded stone aggregate 12.5 mm nominal size) with wooden plugs of 6mm bar nibs wherever required as per direction of EIC.
- D. 15 mm cement plaster on the rough side of single or half brick wall all completed as per specification and direction of EIC.
- E. Labour for erection and installation of RCC post in foundation all completed as per specification and direction of EIC (1 number of labour can erect 05 nos. of RCC post per day).
- F. Fencing with RCC post placed at required distance, embedded in cement concrete blocks, every 15th post, last but one end post and corner post shall be strutted on both side and end post one side only, provided with horizontal line and diagonals of four ply two point barbed wire weighing 9.38 kg per 100 mtr(minimum), between the two posts fitted and fixed with GI staples on wooden plugs or GI binding wire tied to 6mm bar, nibs fixed while casting the post (cost of RCC posts, earthwork and concrete to be paid for separately). Payment to be made per meter cost of total length of barbed wire used all completed as per specification and direction of EIC.
- G. Providing and laying in position cement concrete of specification grade excluding the cost of centering and shuttering- All work upto plinth level 1:1.5:3 (1 cement, 1:5 coarse sand (Zone-III), 3 graded stone aggregate 20mm nominal size all completed as per specification & direction of EIC.

Erection of 02 nos. MS Gates

- A. Earth work in excavation by mechanical means (Hydraulic excavator)/ manual means over areas (not exceeding 1.5 m in width or 10 sqm on plan) including getting out and disposal of excavated earth lead upto 50 m and lift upto 1.5 m, as directed by Engineer-In-Charge.
- B. Supplying & Laying common burnt clay F.P.S. (non modular) bricks of class designation 7.5 one Brick flat soling in foundation trenches all complete as per specification & direction of E.I.C..
- C. Providing & Laying 1:3:6 (1 Cement : 3 coarse sand (zone-III) derived from natural sources : 6 graded stone aggregate 20 mm nominal size derived from natural sources) all completed as per specification & direction of EIC.
- D. Providing and laying in position specified grade of reinforced cement concrete M20 1:1.5:3 (1 cement : 1.5 coarse sand (zone-III) derived from natural sources : 3 graded stone aggregate 20 mm nominal size derived from natural sources), excluding the

cost of centering, shuttering, finishing and reinforcement - All work up to plinth/Ground level as per specification & direction of EIC

- E. Centring & Shuttering below G.L all complete as per specification & direction of EIC.
- F. Providing and laying in position specified grade of reinforced cement concrete M20 1:1.5:3 (1 cement : 1.5 coarse sand (zone-III) derived from natural sources : 3 graded stone aggregate 20 mm nominal size derived from natural sources), excluding the cost of centering, shuttering, finishing and reinforcement - All work up to above ground level as per specification & direction of EIC (In Colum).
- G. Centering & Shuttering below G.L all complete as per specification & direction of EIC (In Colum).
- H. Thermo-Mechanically Treated bars of grade Fe-500D or more, Steel reinforcement for R.C.C. work including straightening, cutting, bending, placing in position and binding all complete as per specification & direction of EIC.
- I. Filling available excavated earth (excluding rock) in trenches, plinth, sides of foundations etc. in layers not exceeding 20cm in depth, consolidating each deposited layer by ramming and watering, lead up to 50 m and lift upto 1.5 m. all complete as per specification & direction of EIC.
- J. Brick work with common burnt clay F.P.S. (non modular) bricks of class designation 7.5 in superstructure above plinth level upto floor V level in all shapes and sizes in cement mortar 1:4 (1 cement: 4 coarse sand) all completed as per specification & direction of EIC.
- K. Providing 12mm thick cement plaster in faced in cm (1:6) all completed as per specification & direction of EIC.
- L. Distempering with oil bound washable distemper of approved brand and manufacturing to give an even shade. New work (two or more coats) over and including water thinnable priming cat with cement primer all completed as per specification & direction of EIC.
- M. Supplying, fabricating, fitting & fixing hollow square pipe of size 35mm x 35mm & wall thickness of 1mm for M S gate alongwithmsaldrop, gate stopper all complete as per specification & direction of EIC(Size of Gate 2.25m x 2.85m).
- N. Providing Hot rolled deformed bars in Arrow at top section(In Ascending order) (16mm dia round bar for arrow) all complete as per specification & direction of EIC(1.58kg/m)
- O. (T-section MS hinge clamp) Rolled steel equal angle ISA 50x50x6 mm for fixing the ms gate in the wall
- P. Applying priming first coat: With ready mixed red oxide zinc chromate primer of approved brand and manufacture on steel galvanised iron/ steel works all complete as per specification and direction of E.I.C
- Q. Applying priming second coat: With ready mixed red oxide zinc chromate primer of approved brand and manufacture on steel work (second coat) all complete as per specification and direction of E.I.C.
- R. Painting on G.S. sheet with synthetic enamel paint of approved brand and manufacturing of required colour to give an even shade. New work (two or more coats) including a coat of approved steel primer but excluding a coat of mordant solution all completed as per specification & direction of EIC.

Note:

1. **Cube test Report shall be submitted by the contractor before execution of the work.**
2. **Before laying of Cement Concrete a pour card report alongwith the cube test report of that batch shall be submitted by the contractor after certification of representative of EIC. If not submitted the payment for the same shall not be released in any condition.**

PART-IV
BILL OF QUANTITIES

Validate		Print		Help			
Tender Inviting Authority: Inland Waterways Authority Of India							
Name of Work: Providing Barbed wire fencing alongwith two nos entry & exit gate at 120 acres of acquired land of ICLP at Sahibganj during 2022-23							
Contract No: IWAI/KOL/8/SAHIBGANJ/2022-23							
Name of the Bidder/ Bidding Firm / Company :							
<u>PRICE SCHEDULE</u>							
(This BOQ template must not be modified/replaced by the bidder and the same should be uploaded after filling the relevant columns, else the bidder is liable to be rejected for this tender. Bidders are allowed to enter the Bidder Name and Values only)							
NUMBE R #	TEXT #	TEXT #	NUMBER #	TEXT #	NUMBER #	NUMBER #	TEXT #
Sl. No.	Item Description	Item Code / Make	Quantity	Units	BASIC RATE In Figures To be entered by the Bidder in Rs. P	TOTAL AMOUNT in Rs. P	TOTAL AMOUNT In Words
1.00	Fabrication & Erection of RCC posts with Barbed wire fencing	item1					
1.01	Earth work in excavation by mechanical means (Hydraulic excavator)/ manual means over areas (not exceeding 1.5 m in width or 10 sqm on plan) including getting out and disposal of excavated earth lead upto 50 m and lift upto 1.5 m, as directed by Engineer-In-Charge	item2	292.50	cum		0.00	INR Zero Only
1.02	Providing and laying in position cement concrete of specified grade excluding the cost of centering and shuttering. All work upto plinth level 1:1.5:3 (1 cement, 1:5 coarse sand (Zone-III), 3 graded stone aggregate 20mm nominal size all completed as per specification & direction of EIC. (Quality: Total volume of earthwork in excavation in foundation trenches- Total volume of RCC standard post in foundation trenches)	item3	266.18	cum		0.00	INR Zero Only
1.03	Supplying of RCC standards post of mixing 1:1.5:3 (1 cement, 1:5 coarse sand (Zone-III), 3 graded stone aggregate 12.5 mm nominal size) with wooden plugs of 6mm bar nibs wherever required as per direction of EIC (cost of each work in excavation, concrete work in foundation to be paid separately) all completed as per specification and direction of EIC	item4	70.2	cum		0.00	INR Zero Only
1.04	Labour for erection and installation of RCC post in foundation all completed as per specification and direction of EIC (1number of labour can erect 05 nos. of RCC post per day)	Item5	260.00	no.		0.00	INR Zero Only

1.05	Fencing with RCC post placed at required distance, embedded in cement concrete blocks, every 15th post, last but one end post and corner post shall be strutted on both side and end post one side only, provided with horizontal line and diagonals of four ply two point barbed wire weighing 9.38 kg per 100 mtr(minimum), between the two posts fitted and fixed with GI staples on wooden plugs or GI binding wire tied to 6mm bar, nibs fixed while casting the post (cost of RCC posts, earthwork and concrete to be paid for separately). Payment to be made per meter cost of total length of barbed wire used all completed as per specification and direction of EIC (Add 5% extra for wastage)	Item6	33369	mtr		0.00	INR Zero Only
2.00	Fabrication & Erection of MS gate(2 nos)	Item7					
2.01	Earth work in excavation by mechanical means (Hydraulic excavator)/ manual means over areas (not exceeding 1.5 m in width or 10 sqm on plan) including getting out and disposal of excavated earth lead upto 50 m and lift upto 1.5 m, as directed by Engineer-In-Charge	Item8	4.00	cum		0.00	INR Zero Only
2.02	Supplying & Laying common burnt clay F.P.S. (non modular) bricks of class designation 7.5 one Brick flat soling in foundation trenches all complete as per specification & direction of E.I.C	Item9	132.00	no.		0.00	INR Zero Only
2.03	Providing & Laying 1:3:6 (1 Cement : 3 coarse sand (zone-III) derived from natural sources : 6 graded stone aggregate 20 mm nominal size derived from natural sources) all completed as per specification & direction of EIC	item10	0.40	cum		0.00	INR Zero Only
2.04	Providing and laying in position specified grade of reinforced cement concrete M20 1:1.5:3 (1 cement : 1.5 coarse sand (zone-III) derived from natural sources : 3 graded stone aggregate 20 mm nominal size derived from natural sources), excluding the cost of centering, shuttering, finishing and reinforcement - All work up to plinth/Ground level as per specification & direction of EIC	item11	0.80	cum		0.00	INR Zero Only
2.05	Centering & Shuttering below G.L all complete as per specification & direction of EIC	item12	6.32	sqm		0.00	INR Zero Only
2.06	Providing and laying in position specified grade of reinforced cement concrete M20 1:1.5:3 (1 cement : 1.5 coarse sand (zone-III) derived from natural sources : 3 graded stone aggregate 20 mm nominal size derived from natural sources), excluding the cost of centering, shuttering, finishing and reinforcement - All work up to above ground level as per specification & direction of EIC (In Colum)	item13	1.40	cum		0.00	INR Zero Only
2.07	Centering & Shuttering below G.L all complete as per specification & direction of EIC (In Colum)	item14	15.00	sqm		0.00	INR Zero Only

2.08	Thermo-Mechanically Treated bars of grade Fe-500D or more, Steel reinforcement for R.C.C. work including straightening, cutting, bending, placing in position and binding all complete as per specification & direction of EIC	Item15	258.86	kg		0.00	INR Zero Only
2.09	Filling available excavated earth (excluding rock) in trenches, plinth, sides of foundations etc. in layers not exceeding 20cm in depth, consolidating each deposited layer by ramming and watering, lead up to 50 m and lift upto 1.5 m. all complete as per specification & direction of EIC	Item16	2.62	cum		0.00	INR Zero Only
2.10	Brick work with common burnt clay F.P.S. (non modular) bricks of class designation 7.5 in superstructure above plinth level upto floor V level in all shapes and sizes in cement mortar 1:4 (1 cement: 4 coarse sand) all completed as per specification & direction of EIC	Item17	2.50	cum		0.00	INR Zero Only
2.11	Providing 12mm thick cement plaster in faced in cm (1:6) all completed as per specification & direction of EIC	Item18	25.00	sqm		0.00	INR Zero Only
2.12	Distempering with oil bound washable distemper of approved brand and manufacturing to give an even shade. New work (two or more coats) over and including water thinnable priming cat with cement primer all completed as per specification & direction of EIC.	Item19	26.56	sqm		0.00	INR Zero Only
2.13	Supplying, fabricating, fitting & fixing hollow square pipe of size 35mm x 35mm & wall thickness of 1mm for M S gate along with ms aldrop, gate stopper all complete as per specification & direction of EIC	Item20	130.60	kg		0.00	INR Zero Only
2.14	Providing Hot rolled deformed bars in Arrow at top section(In Acending order) (16mm dia round bar for arrow) all complete as per specification & direction of EIC	Item21	26.54	kg		0.00	INR Zero Only
2.15	(T-section MS hinge clamp) Rolled steel equal angle ISA 50x50x6 mm for fixing the ms gate in the wall	Item22	36.00	kg		0.00	INR Zero Only
2.16	Applying priming first coat: With ready mixed red oxide zinc chromate primer of approved brand and manufacture on steel galvanised iron/ steel works all complete as per specification and direction of E.I.C	Item23	2	job			INR Zero Only
2.17	Applying priming second coat: With ready mixed red oxide zinc chromate primer of approved brand and manufacture on steel work (second coat) all complete as per specification and direction of E.I.C	Item24	2	job			INR Zero Only
2.18	Painting on G.S. sheet with synthetic enamel paint of approved brand and manufacturing of required colour to give and even shade. New work (two or more coats) including a coat of approved steel primer but excluding a coat of mordant solution all completed as per specification & direction of EIC	Item25	2	job			INR Zero Only
Total in Figures						0	INR Zero Only
Quoted Rate in Words	GST as applicable will be reimbursed on proper submission of documentary evidence	INR Zero Only					

PART - V

Annexure -I

AGREEMENT FORMAT

This agreement made on _____day____year____between the Inland Waterways Authority of India (hereinafter called the 'IWAI' which expression shall unless excluded by or repugnant, to the context, be deemed to include heir, successors in office) on one part and M/S_____ (hereinafter called the 'CONTRACTOR' which expression, shall unless excluded by repugnant to the context be deemed to include his heirs, executors, Administrators, representatives and assigns of successors in office) on the other part.

WHEREAS THE IWAI desirous of undertaking the works_____

WHEREAS the contractor has offered to execute and complete such works and whereas IWAI has accepted the tender of the contractor and WHEREAS the contractor has furnished _____ as security for the due fulfillment for all the conditions of this contract.

NOW IN THIS AGREEMENT WITNESSTH AS FOLLOWS

In this agreement words and expression shall have the same meaning as are respectively as assigned to them in the conditions of contract hereinafter referred to:

The following documents shall be deemed to form and be read and construed as part of this agreement VIZ.

- i) (a) Notice Inviting Tenders
- (b) Tender form
- (c) Warranty
- ii) Information & instruction for Tenders
- iii) (a) Schedule : Bill of Quantity
- (b) Annexure
- iv) General Conditions of Contract
- v) Technical specifications and Special Conditions of Contract

The contract agreement has been compiled by the IWAI from the original tender documents and all the correspondences from the tendering stage till acceptance. In the event of any difference arising from the completion of the contract, the original tender documents, contractor's offer, minutes of meetings and correspondence between the party ended vide letter No._____ may be referred to by either party. These documents shall take precedence over the compiled documents.

The contractor hereby covenants with the IWAI to complete and maintain the "Works" in conformity in all respect, with the provisions of the agreement.

The IWAI hereby covenants to pay the contractor in consideration of such completion of works, the contract price at the time and in the manner prescribed by the contract.

IN WITNESS WHEREOF the parties hereunto have set their hands and seals on the day year first written.

For and on behalf of
(Inland Waterways Authority of India)

For and on behalf of
Contractor

Signature _____

Signature _____

Name & Designation _____ Name & Designation _____

Stamp

Stamp

Witness:

Witness:

1) Signature _____

1) Signature _____

2) Name & Designation _____

2) Name & Designation _____

Annexure –II

**BANK GUARANTEE PROFORMA FOR FURNISHING
PERFORMANCE GUARANTEE**

**To
The Chairman
Inland Waterways Authority of India
A-13, Sector-1
Noida - 201301**

In consideration for the Chairman, Inland Waterways Authority of India hereinafter called "the Authority" having agreed, under the terms and conditions of the Agreement dated made between..... and ...for the due fulfillment of the said Agreement by the Contractor of the terms and conditions contained in the said Agreement, on production of Bank Guarantee for Rs..... (Rupees.....) at the request of..... Contractor(s), We (Bank) do hereby undertake to pay to the Authority an amount not exceeding Rs..... against any loss or damage caused to or suffered, or would be caused to or suffered by the Authority by reason of any breach of the said Contractor(s) of any of the terms or conditions contained in the said Agreement.

2. We..... do hereby undertake to pay the amount due and payable under this Guarantee without any demur, merely on a demand from the Authority stating that the amount claimed is due by way of loss or damage caused to or would be caused to or suffered by the authority by reason of breach by the said contractor(s) of any of the terms or conditions contained in the said Agreement or by reason of the contractor(s)'s failure to perform the said Agreement,. Any such demand made on the Bank shall be conclusive as regards the amount due and payable by the Bank under this guarantee. However, our liability under this guarantee shall be restricted to an amount not exceeding Rs.....

3. We undertake to pay the authority any money so demanded notwithstanding any dispute or disputes raised by the contractor(s) / suppliers(s) in any suit or proceeding pending before any court or Tribunal relating thereto liability under this present being absolute and unequivocal.

The payment so made by us under this Bond shall be valid discharge of our liability for payment there under and the contractor(s) / supplier(s) shall have no claim against us for making such payment.

4. We, further agree that the guarantee herein contained shall remain in full force and effect during the period that would be taken for the performance of the said Agreement and that it shall continue to be enforceable till all the dues of the Authority under or by virtue of the said Agreement have been fully and its claim satisfied or discharge or till..... Certify that the terms and conditions of the said Agreement have been fully and properly carried out by the said Contactor(s) and accordingly discharges this Guarantee after..... years from the date of completion of the said contract unless a demand or claim under this Guarantee is served in writing on the bank but before the expiry of the said period of years in which case it shall be enforceable against the bank not withstanding the fact that the same is enforced after the expiry of the said period of years.

5. We,.....further agree with the Authority that the Authority shall have the fullest liberty without our consent and without affecting in any manner our obligations hereunder to vary any of the terms and conditions of the said Agreement or to extend time of performance by the said Contractor(s) from time to time or to postpone for any time or from time to time any of the powers exercisable by the Authority against the said Contactor(s) and to forbear or enforce any of the terms and conditions relating to the said Agreement and we shall not be relived from our liability by reason of any such variation, or extension being granted to the said Contractor(s) or for any forbearance, act or omission on the part of the Authority or any indulgence by the Authority to the said Contractor(s) or by any such matter or thing whatsoever which under the law relating to sureties would, but for the provision, have effect of so relieving us.

6. It shall not be necessary for the Authority to proceed against the Contractor before proceeding against the Bank and the Guarantee herein contained shall be enforceable against the Bank notwithstanding any security which the Authority may have obtained or obtain from the Contractor shall at the time when proceedings are taken against the Bank hereunder be outstanding or unrealized.

7. Notwithstanding anything contained herein above our liability under the guarantee is restricted to Rs..... and shall remain in force until..... Unless a claim or suit under this guarantee is filed with us on or before..... ALL OUR RIGHTS UNDER THE GUARANTEE SHALL BE FORFEITED and the bank shall be relieved and discharged from all liabilities therein.

8. This Guarantee will not be discharged due to the change in the constitution of the Bank or the Contractor(s) / supplier(s).

9. We,..... lastly undertake not to revoke this Guarantee during its currency except with the previous consent of the Authority in writing.

Dated thedate of.....200...
for.....
(indicate the name of Bank)
Signature.....
Name of the Officer.....
(in Block Capitals)
Designation of
Code No.....
Name of the Bank and Branch.

ANNEXURE-III

**SAMPLE FORM FOR SITE ORDERS BOOK
Reference Clause No. 18.4**

Name of work Date of commencement/ period for completion.....

Sl. No.	Date	Remarks of the Inspecting Officer or Contractor	Action taken and by whom	Remarks
1	2	3	4	5

ANNEXURE-IV

PROFORMA FOR HINDRANCE REGISTER
Reference Clause No. 18.5

Sl. No.	Nature of hindrance	Items of work that could not be due executed to this hindrance	Date of start of hindrance	Signature of Representative of EIC	Date of removal of hindrance	Overlapping period, if any	Net hindrance in days	Weightage of this hindrance	Net effective days of hindrance	Remarks of Engineer-in-Charge
1	2	3	4	5	6	7	8	9	10	11

ANNEXURE-V

**Notice for appointment of Arbitrator
[Refer Clause 47]**

To,

The Chairman, IWAI

.....

.....

Dear Sir,

In terms of clause 47 of the agreement, particulars of which are given below, I/we hereby give notice to you to appoint an arbitrator for settlement of disputed mentioned below:

1. Name of applicant
2. Whether applicant is Individual/Prop. Firm/Partnership Firm/Ltd. Co.
3. Full address of the applicant
4. Name of the work and contract number in which arbitration sought
5. Name of the Division which entered into contract
6. Contract amount in the work
7. Date of contract
8. Date of imitiation of work
9. Stipulated date of completion of work
10. Actual date of completion of work (if completed)
11. Total number of claims made
12. Total amount claimed
13. Date of intimation of final bill (if work is completed)
14. Date of payment of final bill (if work is completed)
15. Amount of final bill (if work is completed)
16. Date of request made to Chief Engineer for decision
17. Date of receipt of Chief Engineer's decision
18. Date of appeal made to Chairman, IWAI
19. Date of receipt of the decision of Chairman, IWAI

Specimen signatures of the applicant
(only the person/authority who
signed the contract should sign)

I/We certify that the information given above is true to the best of my/our knowledge. I/We enclose following documents.

1. Statement of claims with amount of claims
- 2.
- 3.
- 4.

Yours faithfully

(Signatures)

Copy in duplicate to:

1. The Regional Director, IWAI

ANNEXURE-VI

**DETAILS OF BANK ACCOUNT FOR RELEASE OF PAYMENT THROUGH ELECTRONIC FUND
TRANSFER SYSTEM**

(TO BE FURNISHED BY THE BIDDER ON IT'S LETTER HEAD)

NAME OF THE PROJECT: _____

THE BANK ACCOUNT DETAILS ARE FURNISHED AS BELOW:

We _____(Name of the Bidder) hereby request you to give our payments by crediting our bank account directly by E-Payment mode as per account details given below. We hereby undertake to intimate IWAI in case of any change in particulars given below and will not hold IWAI responsible for any delay / default due to any technical reasons beyond IWAI's control:-

Bank Account Number : _____

RTGS/NEFT/IFSC CODE : _____

Name of the Bank : _____

Address of the Branch of the Bank: _____

Branch code : _____

Account Type : _____
(Saving/Current/Others)

A BLANK CHEQUE (CANCELLED) IS ENCLOSED HEREWITH.

I/We hereby declare that the particulars given above are correct and complete. If the transaction is delayed or credit is not affected at all for reasons of incomplete or incorrect information, I/We would not hold IWAI responsible.

Date:

Signature of Authorized Signatory

DRAWINGS:

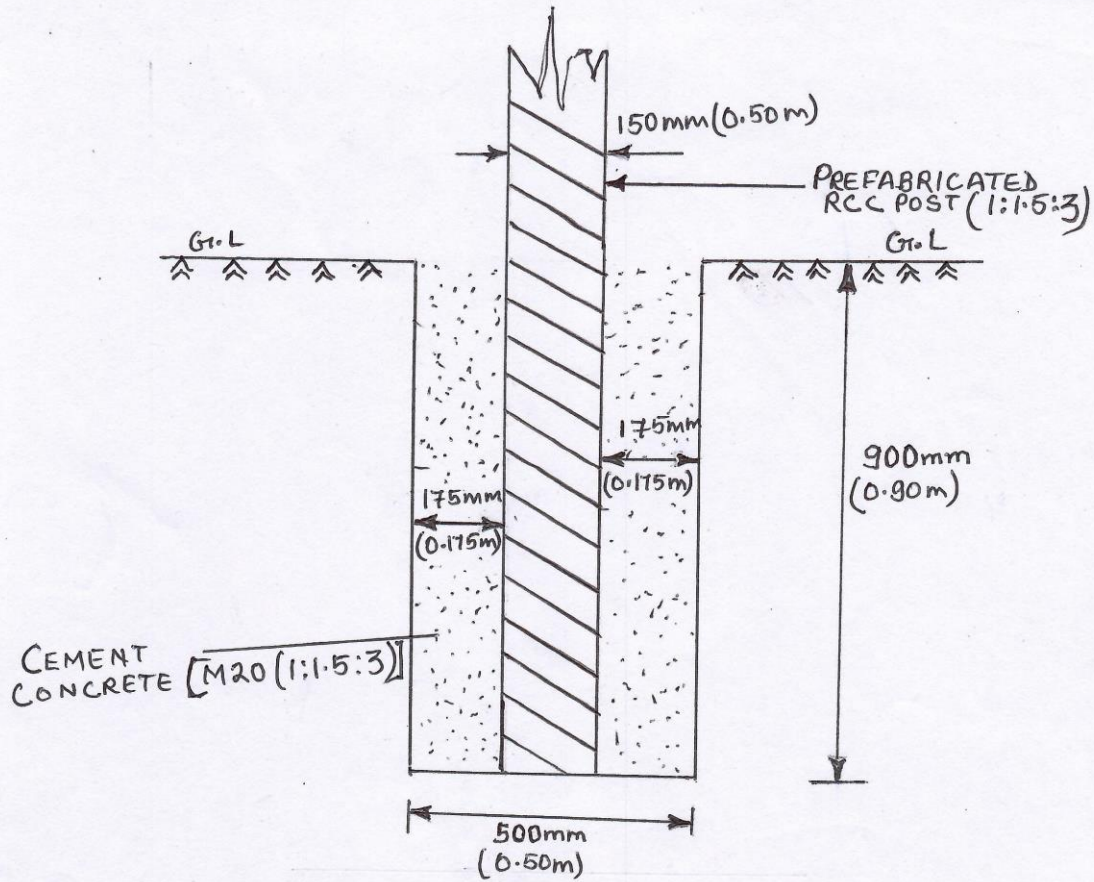

TYPICAL C/S OF FOUNDATION FOR RCC POST

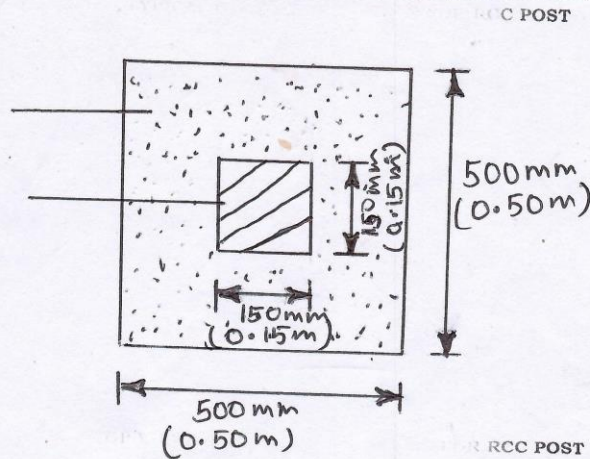

TOP VIEW OF FOUNDATION DETAIL FOR RCC POST

NOT TO SCALE

Providing Barbed wire fencing alongwith two nos entry & exit gate at 120 acres of acquired land of ICLP at Sahibganj during 2022-23

Inland Waterways Authority of India,
(Ministry of Ports, Shipping & Waterways, Govt. of India),

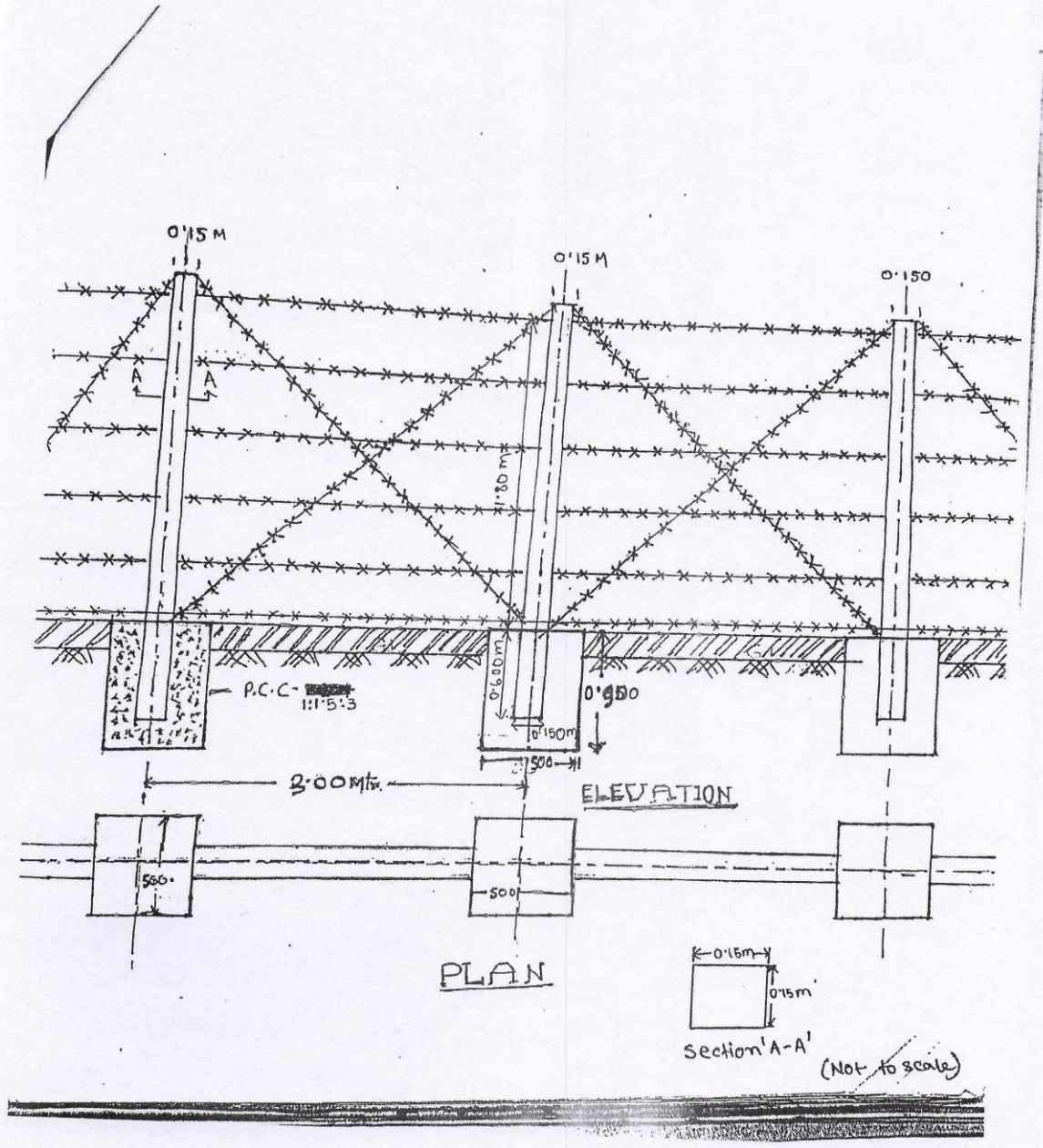

NOT TO SCALE
Scanned with CamScanner

Providing Barbed wire fencing alongwith two nos entry & exit gate at 120 acres of acquired land of ICLP at Sahibganj during 2022-23

Inland Waterways Authority of India,
(Ministry of Ports, Shipping & Waterways, Govt. of India),

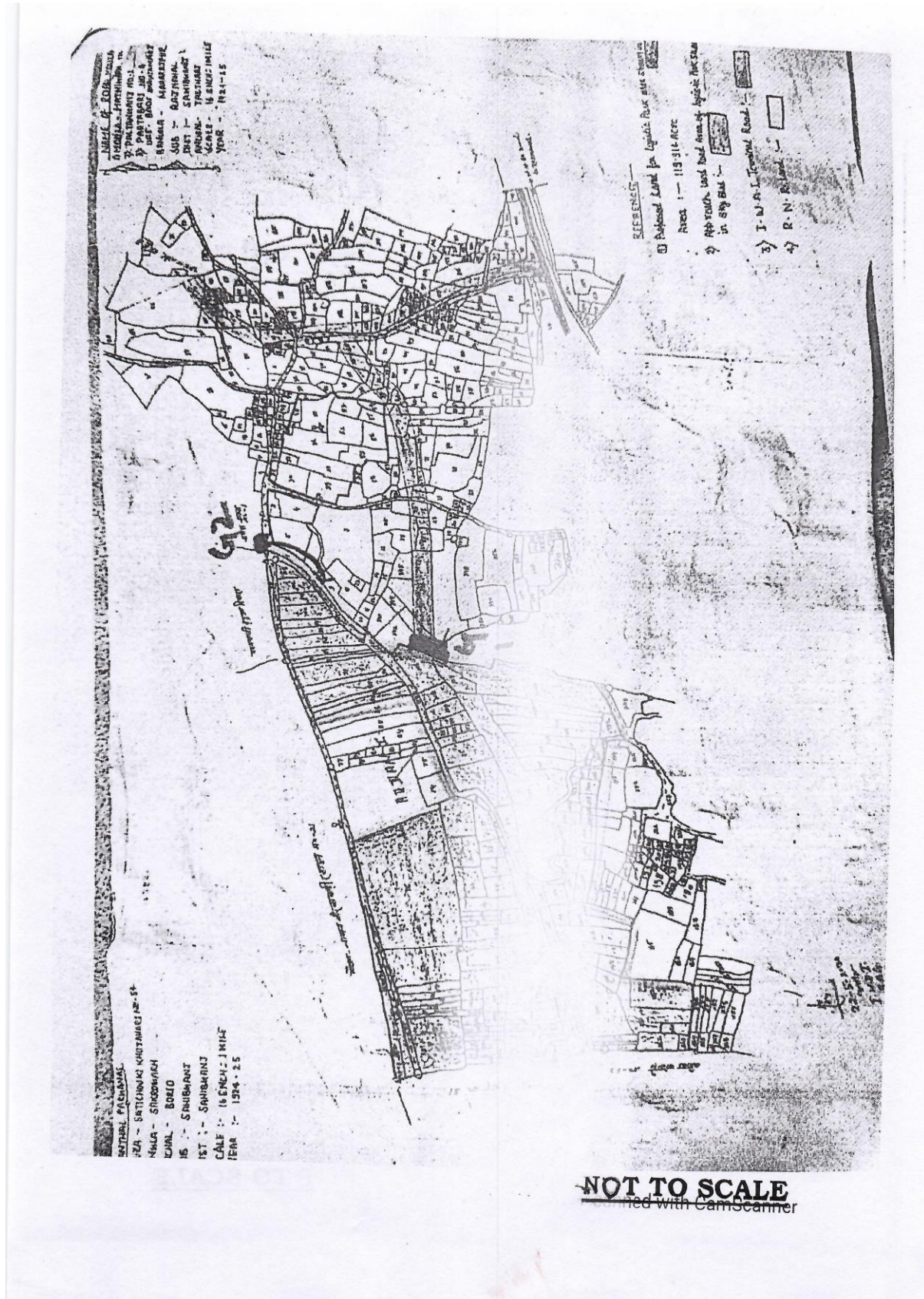

Drawing of Foundation of M/s Gate

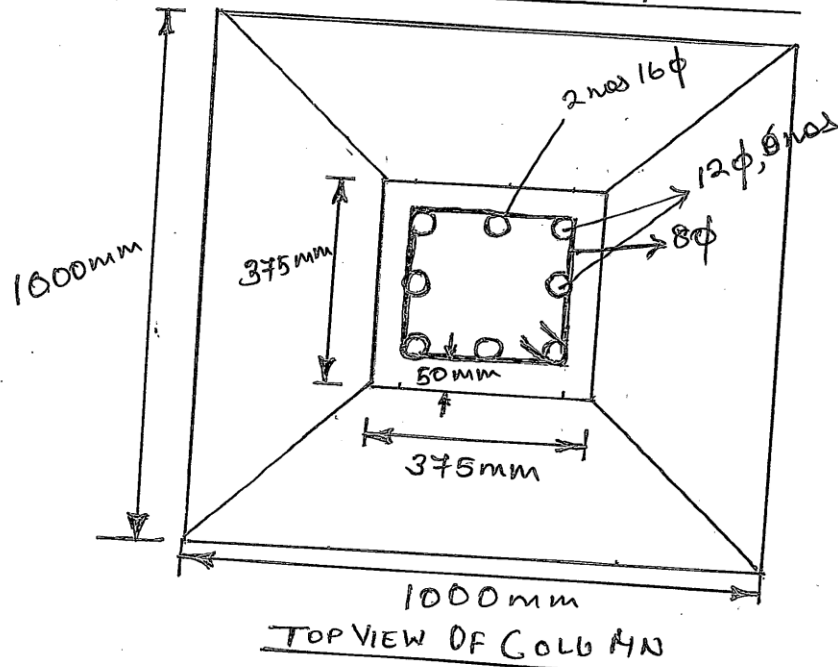
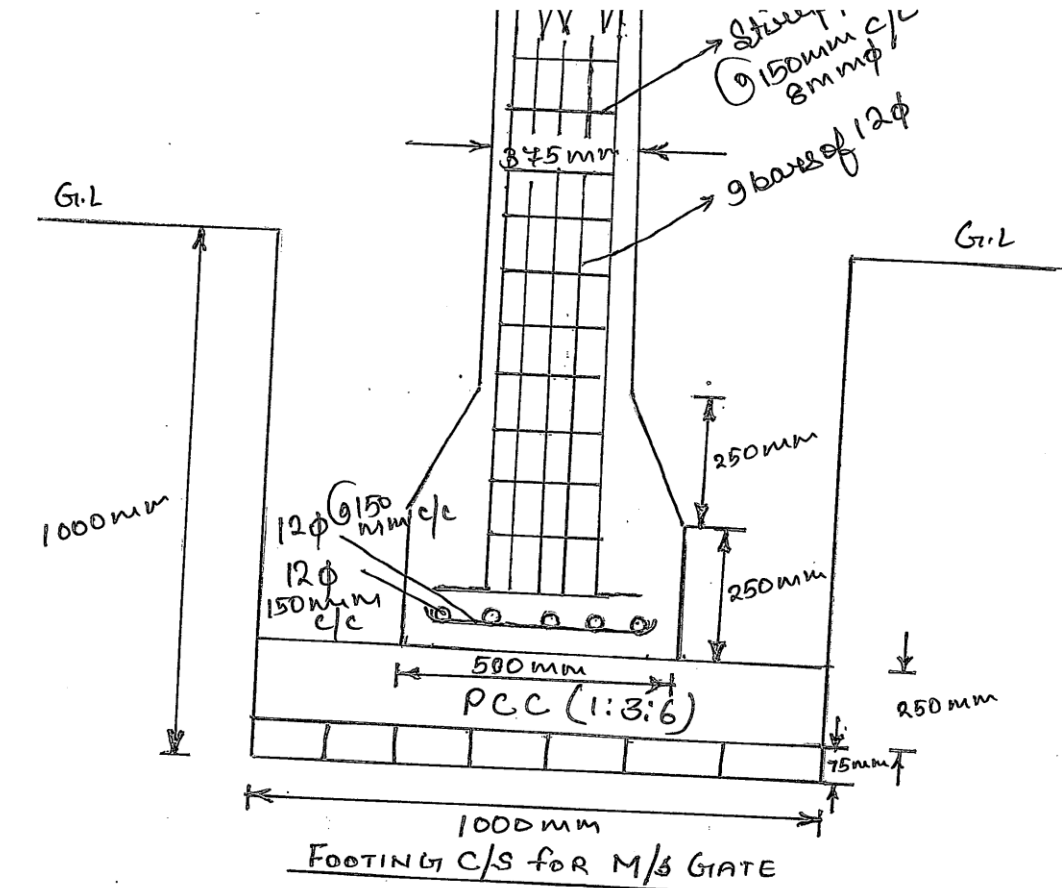

NOT TO SCALE

